

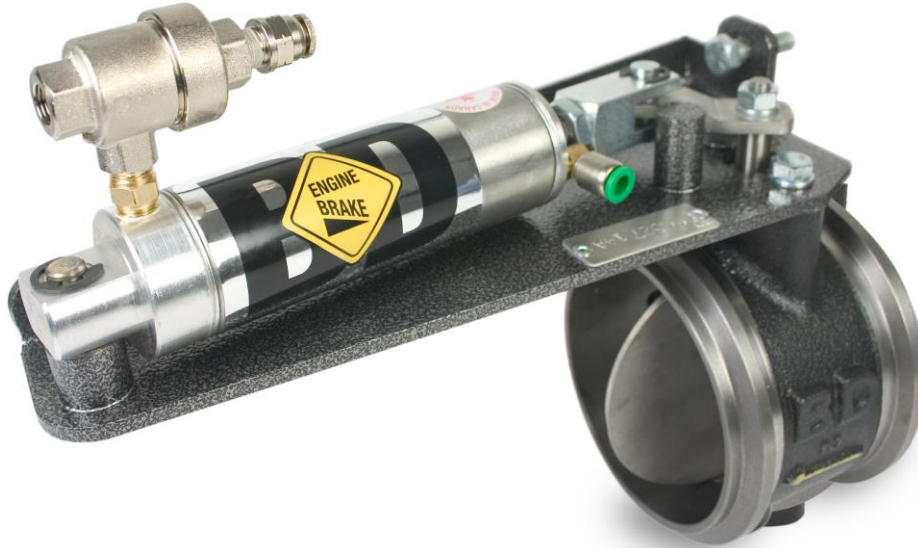

**DOWNLOAD ENHANCED  
INSTALL MANUALS AT  
*dieselperformance.com***



# 2003-2007 Ford 6.0L Powerstroke Remote Mount BD Exhaust Brake

BD P/N	Application
<b>1027145</b>	Ford 6.0L Powerstroke with 3.5" Exhaust (Manual Trans)
<b>1027145AP</b>	Ford 6.0L Powerstroke with 3.5" Exhaust (Auto Trans)
<b>1027146</b>	Ford 6.0L Powerstroke with 4.0" Exhaust (Manual Trans)
<b>1027146AP</b>	Ford 6.0L Powerstroke with 4.0" Exhaust (Auto Trans)

Serial # \_\_\_\_\_

Date Purchased \_\_\_\_\_

Purchased from \_\_\_\_\_

Installed by \_\_\_\_\_

**\*\*\* Please read this manual before starting installation. \*\*\***

**OWNER'S MANUAL - LEAVE IN GLOVE BOX**



**The brake pressure at idle must be checked and adjusted at time of install, at least two weeks after install, and at regular twice a year intervals.**



# Table of Contents

- Kit Contents .....3**
  - Kits 1027145AP / 1027146AP ONLY.....3*
  - Kits 1027145/1027145AP (w/ 3.5” Exhaust) Also Include: .....4
  - Kits 1027146/1027146AP (w/ 4.0” Exhaust) Also Include: .....4
- Introduction.....4**
- Optional Accessories .....5**
- Notes on Connectors.....5**
- Tools Required.....6**
- Installation.....6**
  - Brake Valve Installation .....6
  - Air Hose Installation.....7
  - Vacuum Pump & Reservoir Removal.....8
  - Air Compressor.....9
  - Regulator Installation .....10
  - Pump Relay Harness and Under-hood Plumbing.....10
  - EBP (Exhaust Back Pressure) Sensor Wiring.....12
  - Control Module Install .....14
  - Main Switch Install .....16
- Optional Shifter Switch Installation (Manual Transmissions).....17**
  - Push-Pull Style .....17
  - Rocker Switch Style .....18
- Exhaust Brake Wiring.....19**
- Control Module Calibration .....21**
- Exhaust Brake Testing .....22**
- Common Problems.....23**
- Exhaust Back Pressure Testing Air Actuated Brakes.....24**
- Air Brake Troubleshooting Guide.....26**

## Kit Contents



Please check to make sure that you have received all parts for your kit

<p><b>1127038-A</b></p>	<p><b>1030125-C</b></p>	<p><b>1220113-A</b></p>
		
<p><b>Valve Assembly</b> <b>Qty: 1</b></p>	<p><b>Air Pump Kit</b> <b>Qty: 1</b></p>	<p><b>Air Tubing Assembly</b> <b>Qty: 1</b></p>



<p><b>1220145-D</b></p>	<p><b>1321045</b></p>	<p><b>1030124</b></p>
		
<p><b>Regulator/Control Assy.</b> <b>Qty: 1</b></p>	<p><b>Brake Control Module and Wiring Kit</b> <b>Qty: 1</b></p>	<p><b>Vacuum Pump Relocation Kit</b> <b>Qty: 1</b></p>

		<p><b>Kits 1027145AP / 1027146AP ONLY</b></p>
<p><b>1100404</b></p>	<p><b>1220410</b></p>	<p><b>1031300</b></p>
		
<p><b>4\" data-bbox="68 883 261 903"/&gt; <b>Qty: 2</b></b></p>	<p><b>1/4\" data-bbox="308 883 506 903"/&gt; <b>Qty: 5ft</b></b></p>	<p><b>Ford 6.0L Auto/PressureLoc Kit</b> <b>Qty: 1</b></p>

**Kits 1027145/1027145AP (w/ 3.5" Exhaust) Also Include:**

1100350	1100735
	
<p><b>3.5" Pipe Adapter</b></p>	<p><b>3.5" S/S Exhaust Clamp</b></p>
<p><b>Qty: 2</b></p>	<p><b>Qty: 1</b></p>

**Kits 1027146/1027146AP (w/ 4.0" Exhaust) Also Include:**

1100400	1100740
	
<p><b>4" Pipe Adapter</b></p>	<p><b>4" S/S Exhaust Clamp</b></p>
<p><b>Qty: 2</b></p>	<p><b>Qty: 1</b></p>

***Introduction***





Thank you for purchasing a BD Engine Exhaust Brake.

This manual is divided into different areas to assist you with the installation and operation of your braking unit. We strongly suggest that you write down the kit and serial numbers of your unit in the spaces provided and retain this manual for any future reference.

**Attention:**

On vehicles with automatic transmissions it is necessary to install the 6.0L AutoLoc/PressureLoc (#1031300) to utilize the full performance of the BD exhaust brake. This is included in kits for automatic transmission vehicles.

## Optional Accessories

<b>1300210</b>	<b>1030900</b>
	
<b>Push/Pull Switch Kit</b>	<b>Rocker Switch Kit</b>
<b>1030227</b>	<b>1081160</b>
	
<b>BD Torque Convertor</b>	<b>Cool Down Timer 2</b>

## Notes on Connectors

The kit includes a number of Posi-Tap™ connectors (Gray or Red/Black/Green or Yellow) to tap onto OEM wiring. It is important to select the correct color of connector so that it matches the gauge of the OEM wire that it is being installed on. Using the incorrect connector could cause an inadequate connection and/or the OEM wire could be severed.

OEM Wire	Posi-Tap™ Color
18-22ga	Gray or Red
12-18ga	Black
10-12ga	Green or Yellow

Though these connectors offer a quicker installation, the best option would be to solder the wires and isolate the joints with heat shrink or liquid electrical tape. Proper soldering techniques should be used to ensure adequate connections.

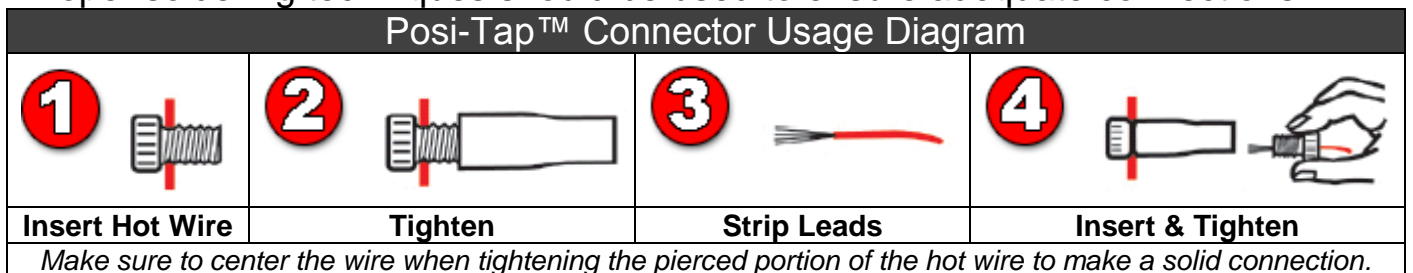

**The ground terminals of the vehicle's batteries should be disconnected before performing any piercing/posi-tapping onto any ECM/PCM wire.**

## Tools Required

- Measuring tape or ruler
- Reciprocating saw or hacksaw
- Wire Crimping Pliers
- Drill with 1/8", 3/16" bits and Uni-bit
- Small bladed flat tip screwdriver
- Socket Set
- Welder
- Heat gun or lighter
- Test light

## Installation

To prevent damage to electronic components, it is recommended that both battery negative terminals be disconnected while working on the vehicle.

**Please read this manual thoroughly before installing this exhaust brake.**



Raise and support the vehicle with a vehicle hoist or with appropriate jack stands.

Ensure vehicle is safely supported before proceeding to reduce possibility of damage or injury.

## Brake Valve Installation

**Note: This kit can be purchased for 4" exhaust or the factory 3.5" exhaust.**

Locate the catalytic converter. About 8" from the rear of the catalytic converter you will need to remove a 7 1/4" section of the exhaust.

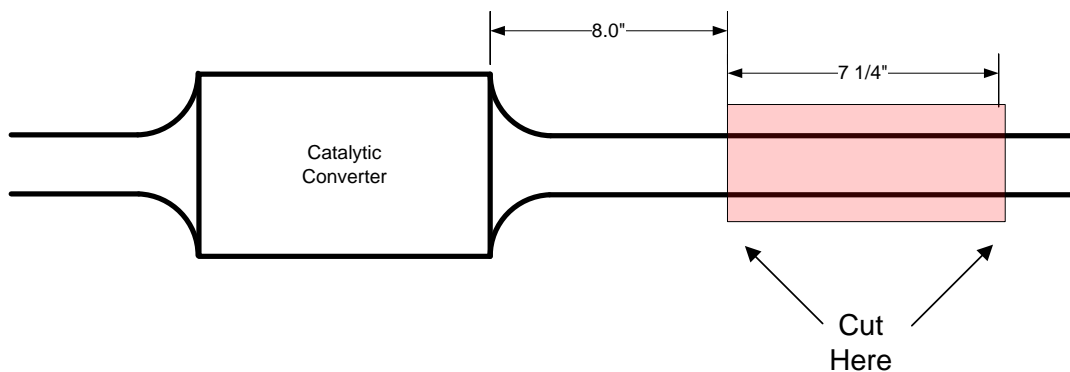

Remove any burrs from the ends of the cut pipes. Slide the supplied pipe adapters over each end of the cut pipes. Weld the adapter closest to the front of the vehicle in place. A good clean weld is needed to seal the high backpressure that the exhaust brake will create. The rear adapter will be secured with the supplied stainless band clamp.

Insert the valve assembly in between the two adapters. Note that there is an arrow cast into the exhaust brake, this should point towards the rear of the vehicle. Secure the brake to the front adapter using the supplied v-band clamp. Slide the rear adapter up to the brake and secure it with the other v-band clamp. Secure the rear adapter to the exhaust pipe with the supplied band clamp.

BD Engine Brake Inc.

Plant Address: 33541 MacLure Rd. Abbotsford, BC, Canada V2S 7W2

U.S. Shipping Address: 88-446 Harrison St, Sumas, WA 98295 U.S. Mailing Address: P.O. Box 231, Sumas, WA 98295

Phone: 604-853-6096 | Fax: 604-853-8749 | Internet: [www.bd-power.com](http://www.bd-power.com)

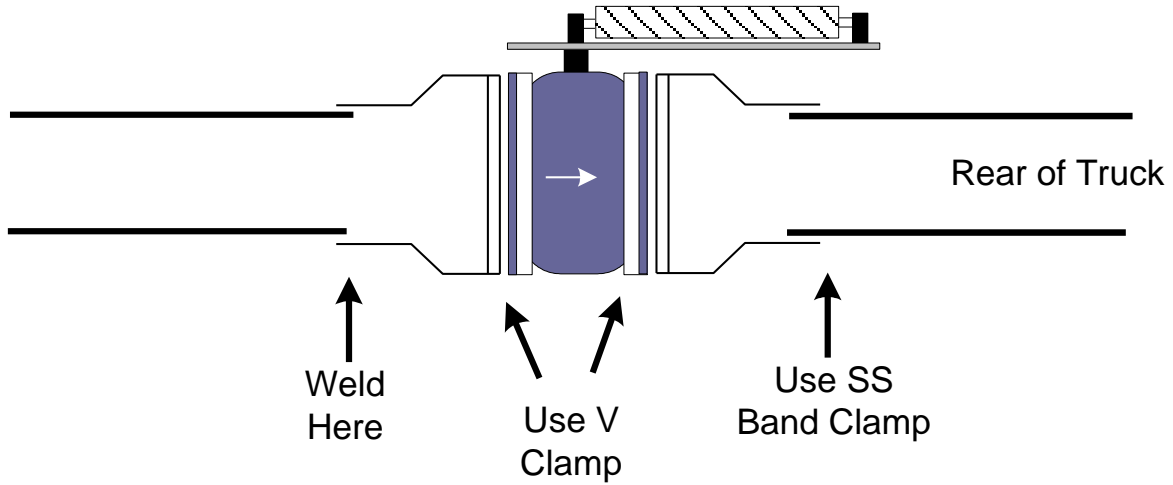

**IMPORTANT** The front exhaust connection **MUST** be welded. Using a band clamp or conventional exhaust clamp on this joint will cause leaks and will not retain full exhaust brake pressures.

### Air Hose Installation

This kit is supplied with a premade air tubing assembly. The 1/8" air tube is the pressurized air feed to the brake pneumatic cylinder and the 1/4" air tube is the vent line for the cylinder.



Insert the 1/8" air tube into the quick connect fitting on the quick release valve on the air cylinder.

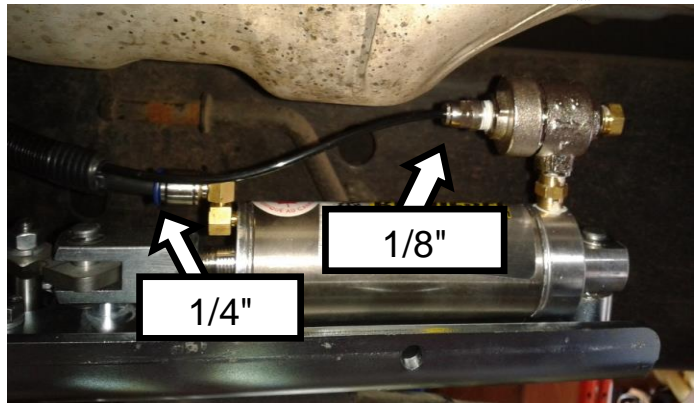

Insert the 1/4" tube into the vent-side quick connect fitting.

Feed the air tubing assembly over the top of the frame rail and support it so that there is no stress on the air tubes where they enter the brake valve.

Route the air tubing assembly along the frame rail and secure with wire ties to the existing wiring harness.

Route the other end of the assembly into the engine bay up the passenger side of the firewall. It will be connected later.



# Vacuum Pump & Reservoir Removal

Locate the small electric vacuum pump and reservoir on the passenger side fender well. Remove the reservoir by removing the bolts attaching it to the fender, disconnecting the electrical connector and removing the air hose.

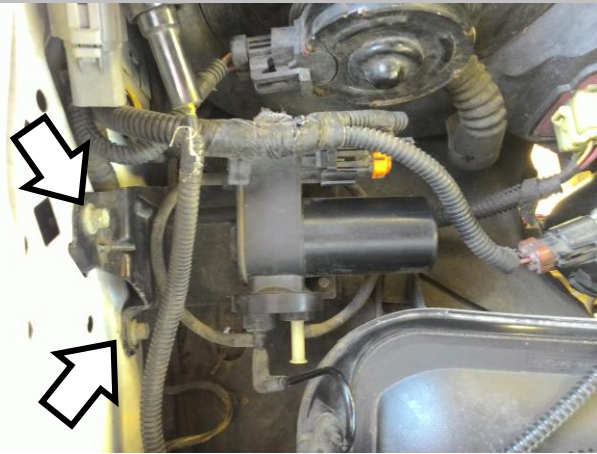

Remove the small electric vacuum pump from the stock bracket by removing the small screws. Reinstall on to the supplied relocation bracket. Trim the rubber ends on the three vibration dampers to clear when reinstalling. Install on the passenger side of the radiator support bracket with the two bolts and washers provided.

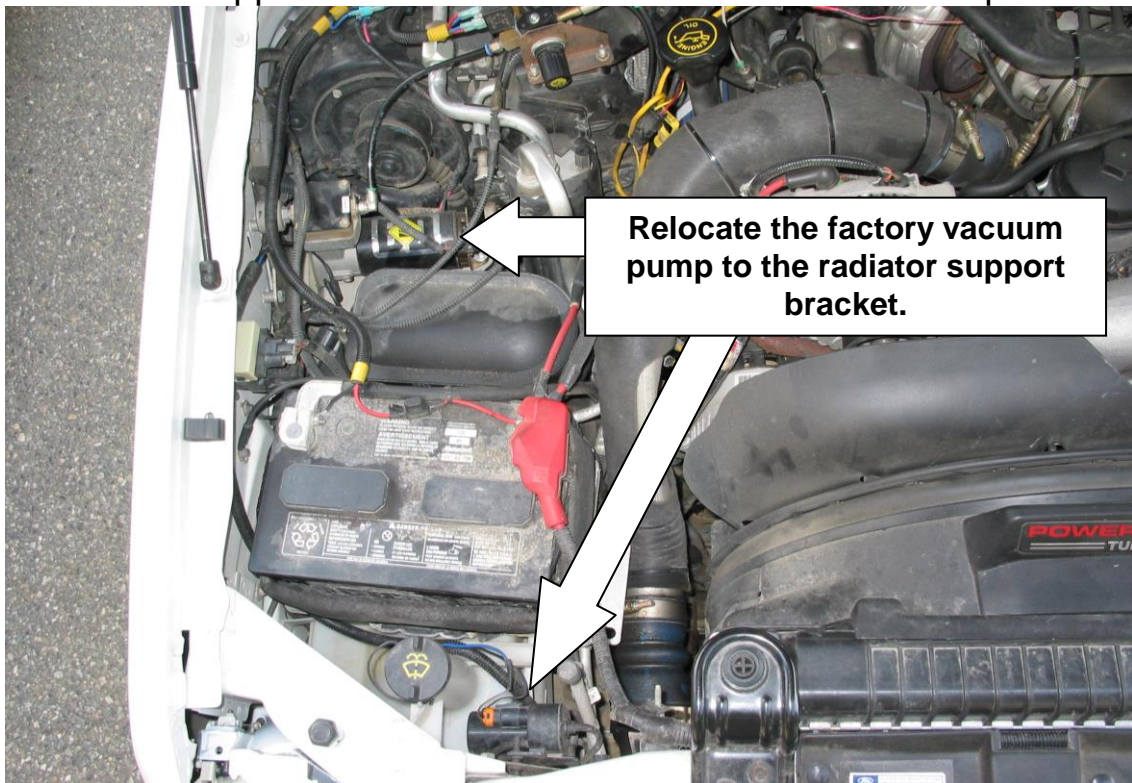

Cut the power supply wires for the electric vacuum pump approximately 4" from the connector and splice in the black and blue wires supplied using the butt connectors and shrink tubing. Route the relocation loom along the fender and towards the front up to the new vacuum pump location. Inside of the loom should be the supplied black and blue wires, along with the 1/8" plastic vacuum tube. Shrink tubing has been provided to securely seal these connections.

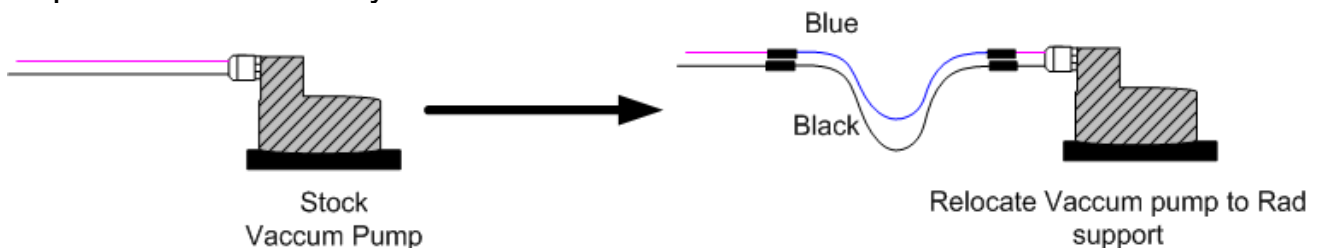



## Air Compressor

The air compressor will mount in the location that the vacuum pump previously occupied.



To install the BD compressor, first remove the two 11mm nuts securing the vacuum reservoir to the fender. These are accessed from in the wheel well below the reservoir.



Once the vacuum reservoir is loose, slide the air compressor bracket under the rear mounting stud for the reservoir.



**Note** Disconnecting the AC pressure switch electrical connector and moving the harness out of the way temporarily will make this process easier.

Install the supplied bolts and lock washers to attach the pump bracket to the fender where the vacuum pump previously attached. Reinstall the two 11mm nuts holding the vacuum reservoir.

BD Engine Brake Inc.

Plant Address: 33541 MacLure Rd. Abbotsford, BC, Canada V2S 7W2

U.S. Shipping Address: 88-446 Harrison St, Sumas, WA 98295 U.S. Mailing Address: P.O. Box 231, Sumas, WA 98295

Phone: 604-853-6096 | Fax: 604-853-8749 | Internet: [www.bd-power.com](http://www.bd-power.com)

## Regulator Installation

The air regulator/control assembly will be mounted to the top of the air conditioning assembly near the firewall. Remove the two front 10mm nuts securing the MAP sensor bracket and remove the 8mm screw from the top of the housing.

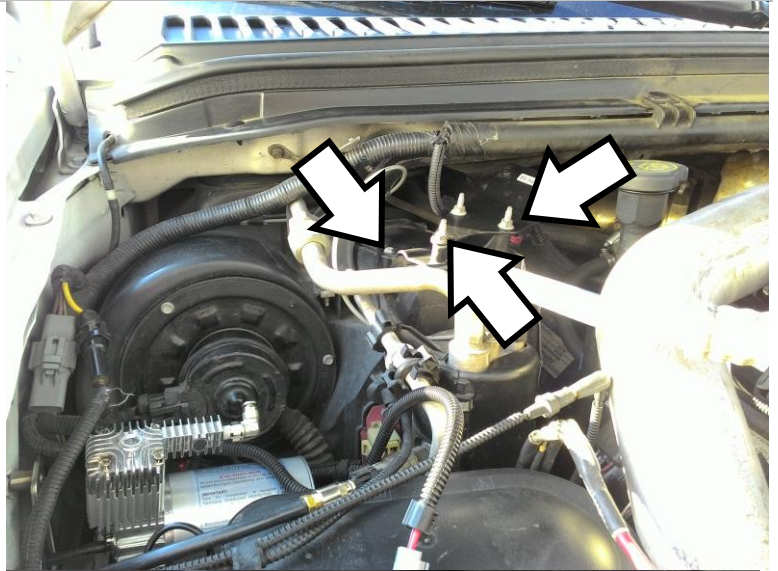

Remove the relay from the relay socket in the supplied wiring harness. Install the relay socket using the small screw in the top of the air conditioner housing and reinstall the 8mm screw. Then install the bracket on the top of the two studs and refasten the 10mm nuts.

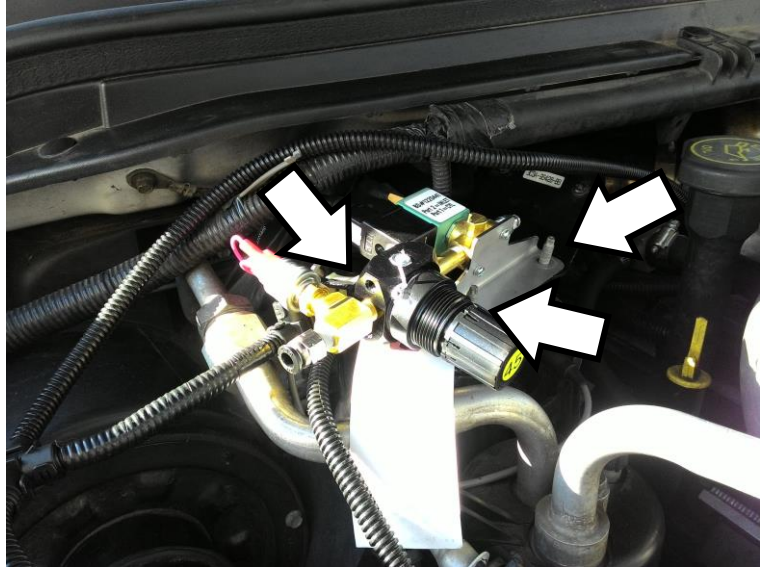

## Pump Relay Harness and Under-hood Plumbing

Starting with the relay harness assembly, connect the female 2 pin connector from the relay harness to the male 2 pin connector on the BD Air compressor.

Route and connect the ground eyelet (black wire) to a bolt on the firewall that will provide a good ground.

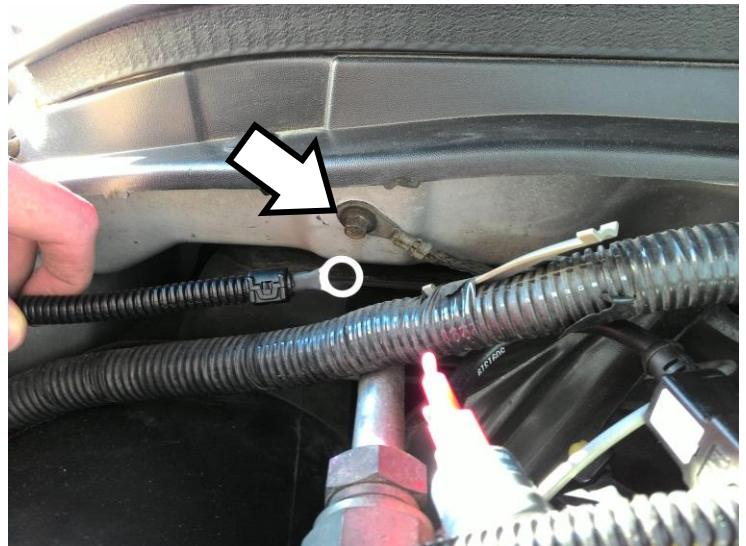

BD Engine Brake Inc.

Plant Address: 33541 MacLure Rd. Abbotsford, BC, Canada V2S 7W2

U.S. Shipping Address: 88-446 Harrison St, Sumas, WA 98295 U.S. Mailing Address: P.O. Box 231, Sumas, WA 98295

Phone: 604-853-6096 | Fax: 604-853-8749 | Internet: [www.bd-power.com](http://www.bd-power.com)

Connect the ring terminal on the red wire to the passenger side positive battery terminal (The negative battery leads should not yet be connected at this time).



Connect the air compressor to the air pressure regulator using a piece of the supplied 1/4" air tube. Cut to approximately 7.5"L. This goes from the outlet of the pump to the inlet of the regulator.

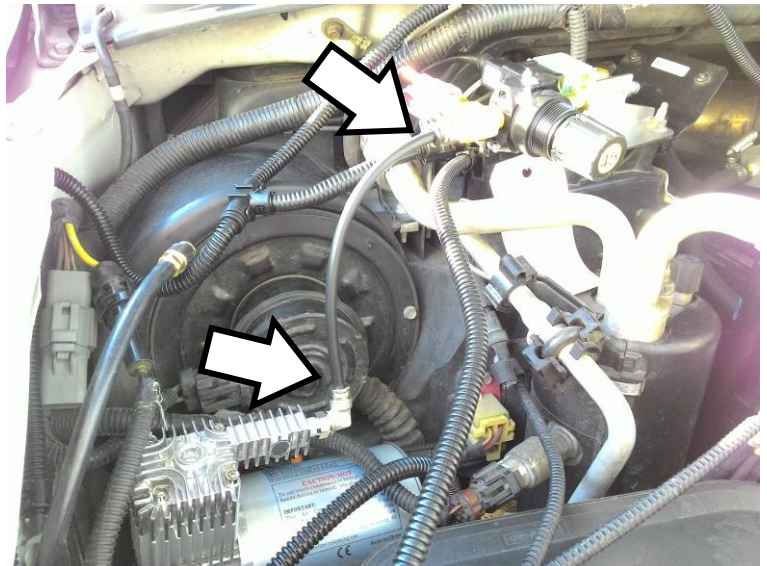

Install the intake air filter for the air compressor by adding a length of 1/4" air tubing to the rubber hose section. Then route this 1/4" line to a dry location (behind the regulator assembly is suggested). Install the "pancake" style filter supplied with the pump to the end of this tube.

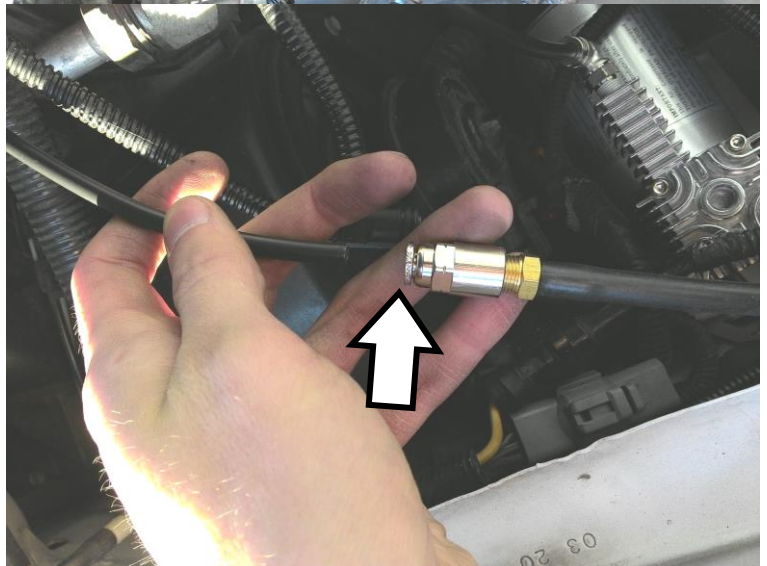

Locate the air tubing assembly previously installed on the brake valve air cylinder. Trim if necessary and install the 1/8" tube onto the outlet of the air solenoid. The other 1/4" line in this assembly is a vent for the air cylinder and may be installed in the same location as the air compressor inlet air filter.

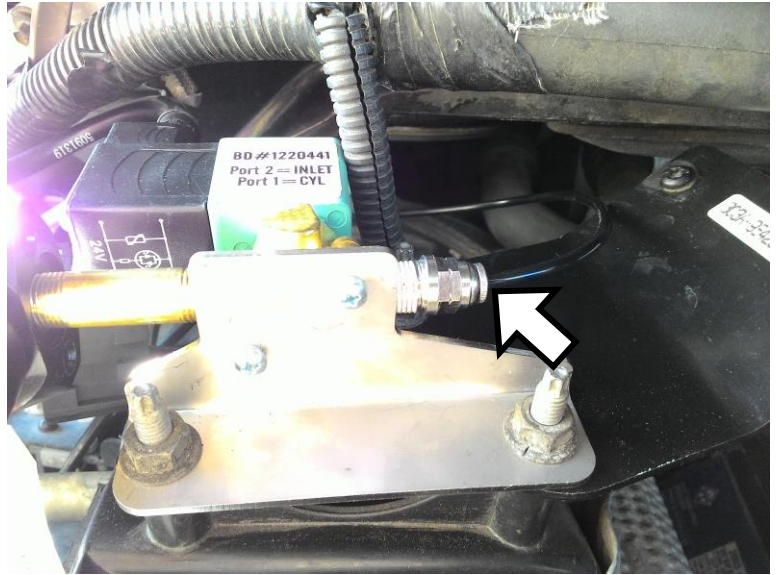

### EBP (Exhaust Back Pressure) Sensor Wiring

Locate the Exhaust Back Pressure (EBP) sensor on the driver's side of the engine. On most models it will be in the location shown but on '03 and early '04 models it is usually about 6" farther back, just in front of the FICM. Disconnect the factory plug from the EBP sensor.

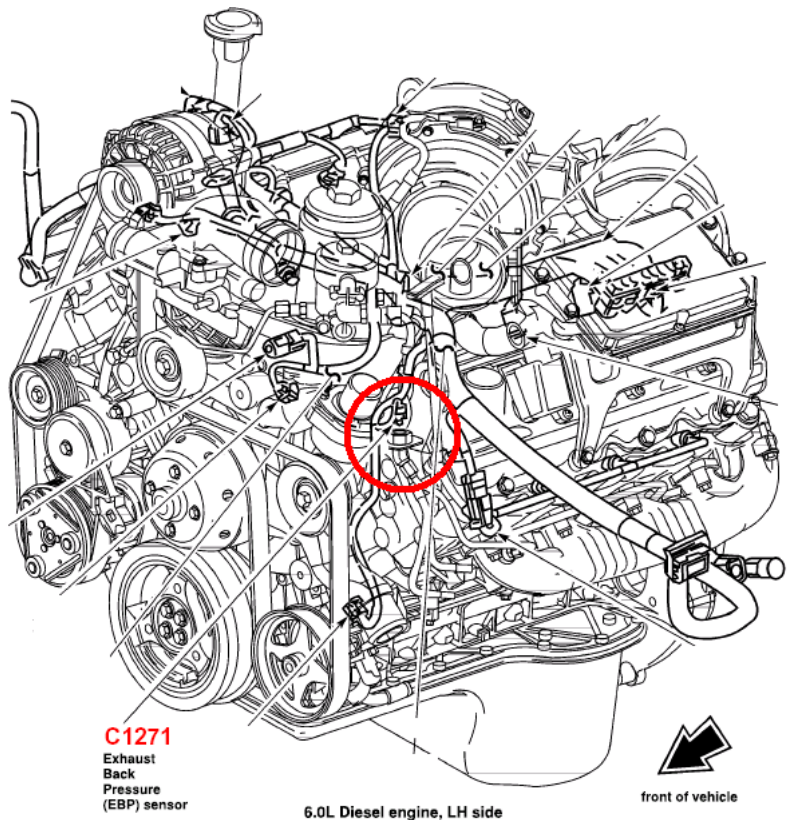

There will be a white guide tab that will either be attached to the end of the factory connector (as shown to the right), or it will be inside the connector portion of the EBP Sensor.

This guide will have to be removed as it will need to be installed into the exhaust brakes' EBP harness.

Once you have removed the guide, insert it into the exhaust brake's EBP harness into the FEMALE CONNECTOR, as shown in the picture to the right.

Connect the factory plug to the female plug on the exhaust brakes EBP harness and the male plug to the EBP sensor. When installing the plugs, be sure that no pins get pressed out the backside when inserting the plugs together.

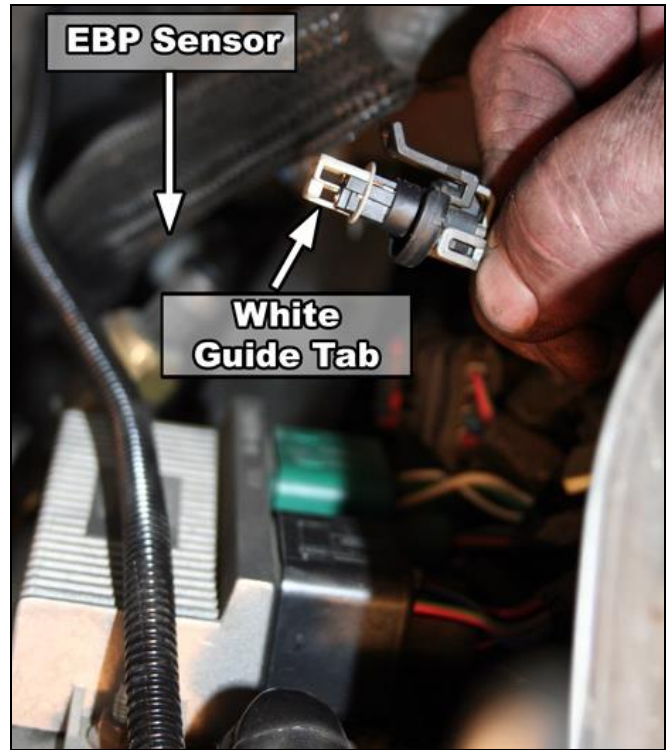

Route the harness away from moving parts or major heat sources and through the firewall to a location under the dash suitable for mounting the brake control module, which will be installed next.



## Control Module Install

Remove the lower dash panel under the steering column. Mount the control module to the cross member under the dash so that you can easily access the adjustment screw and test button on the module. Make sure that the module & its wiring will not interfere with any moving parts.

Connect the Violet wire of the EBP harness to the **EBP Output** terminal on the control module and the white wire to the **EBP Input** terminal.

Locate one of the ignition switched Red /Black tracer wires under the steering column (one is 10/12ga and the other is 14/16ga) and connect an appropriate Posi-Tap connector to it (green for 10/12ga and black for the 14/16ga wire). Also note that fuse #29 in the central junction box underneath the dash will also work.

Connect the red wire to this Posi-Tap and route it to the 12V (Switched power) input of the brake controller.

Crimp one of the supplied ring terminals to the end of the supplied Black wire and attach this to a good clean ground; you can use this point for all under-dash ground connections. Trim the wire to an appropriate length and attach it to the **Ground** terminal on the control module.

Locate the Throttle Position Sensor (TPS) at the throttle pedal. Attach one of the supplied Posi-Tap's to the #1 Signal (rising voltage) wire as indicated in the chart below. This wire will have approximately 0.5 Volts at idle and 4.5 Volts under full throttle, this can be verified once the batteries are reconnected. Run the supplied Yellow wire from this Posi-Tap to the **TPS In** terminal on the control module.

Vehicle Year	APPS/TPS Wire Color
2003-2004	Yellow w/white
2005-2007	White w/Red

Locate the 8-pin connector located just underneath the steering column, towards the passenger side. Attach a Posi-Tap to the Light Blue with Black tracer wire (see chart below for pin location) and run the supplied Green wire from this point to the **Cruise In** terminal on the control module. Crimp one of the supplied ring terminals to the supplied Blue wire and attach it to ground. Run the other end to the **Cruise Out** terminal on the control module.

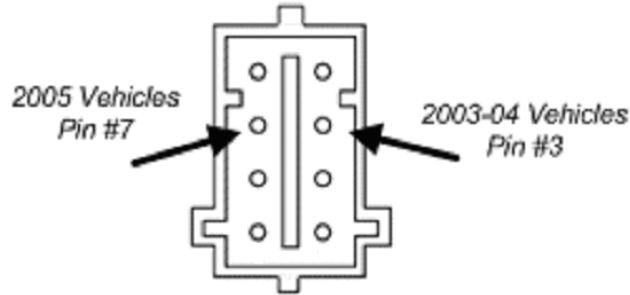

Connect the supplied Pink wire to the **Brake Output** terminal on the control module and the Grey wire to the **VSS In** terminal and route both wires through the firewall.

Run the Pink wire along the top of the firewall, ensuring it does not come too close to the turbocharger, and connect it to the Pink wire on the pressure switch harness using one of the supplied crimp connectors with the clear heat shrink.

Run the Grey wire along the driver's side fender to the PCM. You will need to remove the driver's side battery cover to access the PCM. For easier install remove the locking plugs from the PCM connector and unplug the connector. Use a Posi-Tap to connect the grey wire to the Vehicle Speed Sensor (VSS) wire. This wire is Grey with Black tracer, located on Connector A (closest to firewall), Pin 35. See diagrams below.

Diagram labels include: C124 Brake fluid level switch (2L414), C1159 Engine compartment lamp, C135 ABS control module (2C219), C1381a, C1381b Powertrain Control Module (PCM) (12A650), C1025 Brake pressure switch (2B264), and VIEW AA. An arrow indicates the front of the vehicle.

FEMALE

Wire Color		Pin
VSS Wire	Grey w/Black	35

## Main Switch Install

If you are installing an optional shifter-mounted switch with a manual transmission you can skip installing the toggle switch and proceed to page 17 or 18 for instructions on installing the shifter switches.

On 2005-2007 trucks you can use one of the factory up-fitter switches instead of the supplied toggle switch if you wish. Simply wire the 12 volt output of the up-fitter switch to the Toggle Switch input of the control module.

To use the toggle switch you will need to choose a location in the dash that has room in behind for the switch body. Drill a 1/8" pilot hole and then use a unibit to drill the hole out to 1/2" and mount the switch.

Connect the Black wire to ground and the Red wire to the 12 Volt Switched terminal on the control module. Attach the Tan wire to the Toggle Switch input on the control module.

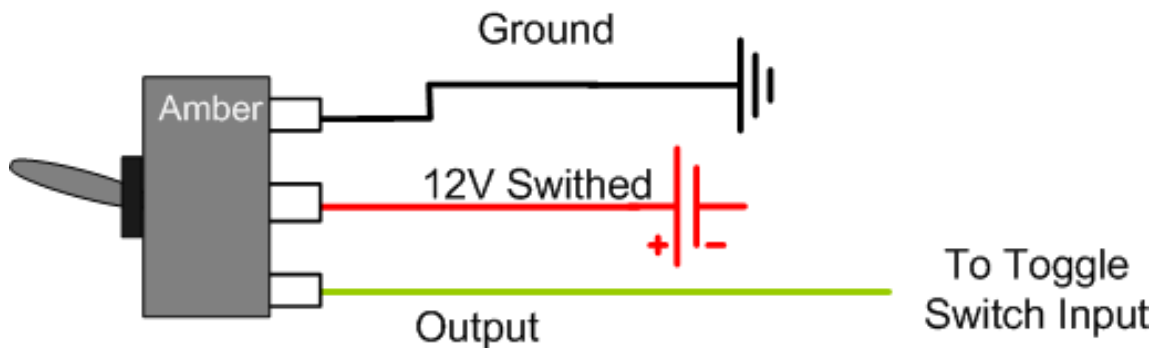

Once the switch is installed you can reconnect the positive terminals on both batteries then reconnect the negative terminals. Reinstall driver's side battery cover.



## **Optional Shifter Switch Installation (Manual Transmissions)**

### **Push-Pull Style**

Mount the shifter switch onto the shift lever using the clamp supplied (either 5/8" or 3/4"). Run the electrical cable down the shifter shaft, securing the cable with zip-ties or electrical tape, and run it under the carpet to the firewall and under the dash to the control module, leaving enough slack for proper shifting of the transmission lever and to prevent any rubbing of wire.

At the end of the cable, cut off any excess and strip away about 1 to 2 inches of the black rubber covering exposing the Black and White (or Green) wires then strip the insulation from the ends of the two wires.



Connect the White (or Green) wire to the "Toggle Switch" terminal on the control Module.

Connect the black wire to the "12 volt switched" input on the control module.

Once the switch is installed you can reconnect the positive terminals on both batteries then reconnect the negative terminals. Reinstall driver's side battery cover.

## Rocker Switch Style

Mount the shifter switch onto the shift lever using the clamp supplied (either 5/8" or 3/4"). Run the electrical cable down the shifter shaft, securing the cable with zip-ties or electrical tape, and run it under the carpet to the firewall and under the dash to the control module, leaving enough slack for proper shifting of the transmission lever and to prevent any rubbing of wire.

At the end of the cable, cut off any excess and strip away about 1-2" of the black rubber insulation exposing the black, white and green wires, then strip the insulation from the ends of the three wires.

Connect the green 12V output wire to the "Toggle Switch" input terminal on the control module.

Attach the 5/16" ring connector to the black ground wire and attach it to ground.

Connect the white wire to the "12 volt switched" input on the control module.

Once the switch is installed you can reconnect the positive terminals on both batteries then reconnect the negative terminals.

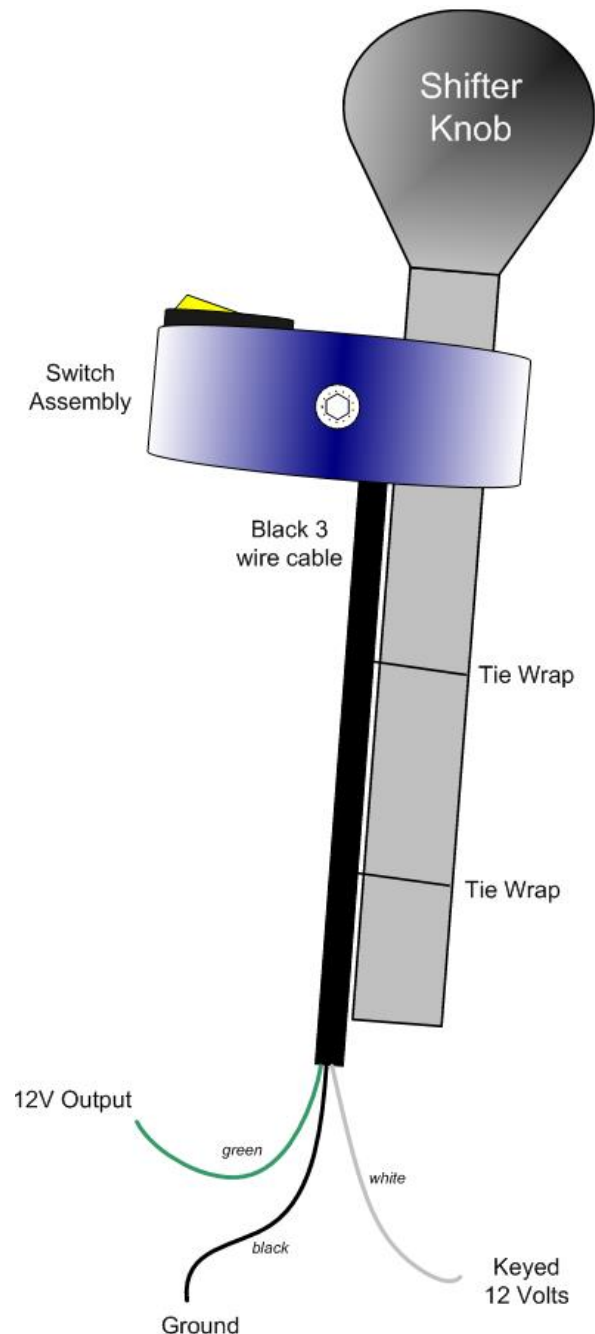

# Exhaust Brake Wiring

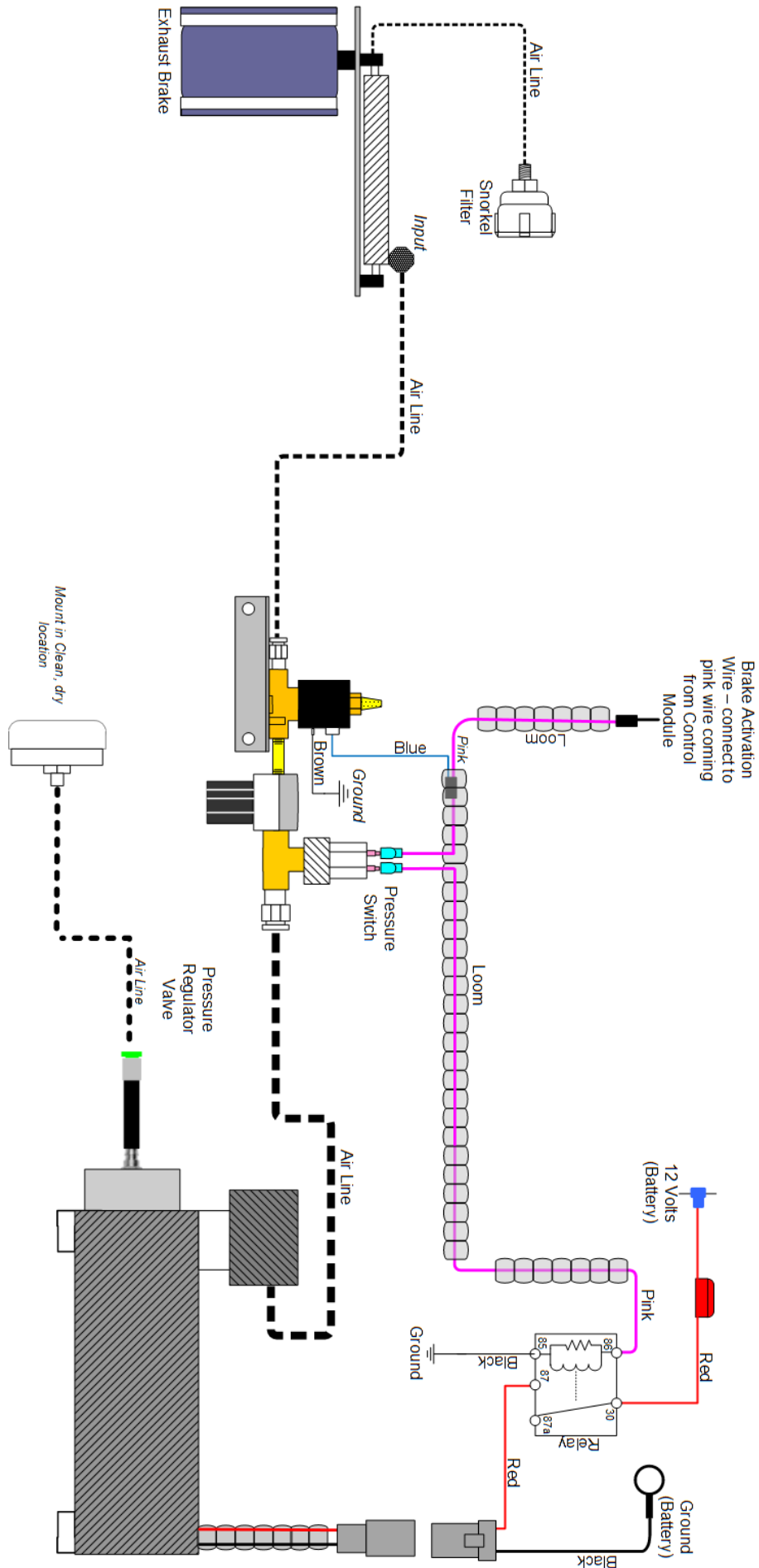

BD Engine Brake Inc.

Plant Address: 33541 MacLure Rd. Abbotsford, BC, Canada V2S 7W2

U.S. Shipping Address: 88-446 Harrison St, Sumas, WA 98295 U.S. Mailing Address: P.O. Box 231, Sumas, WA 98295

Phone: 604-853-6096 | Fax: 604-853-8749 | Internet: www.bd-power.com

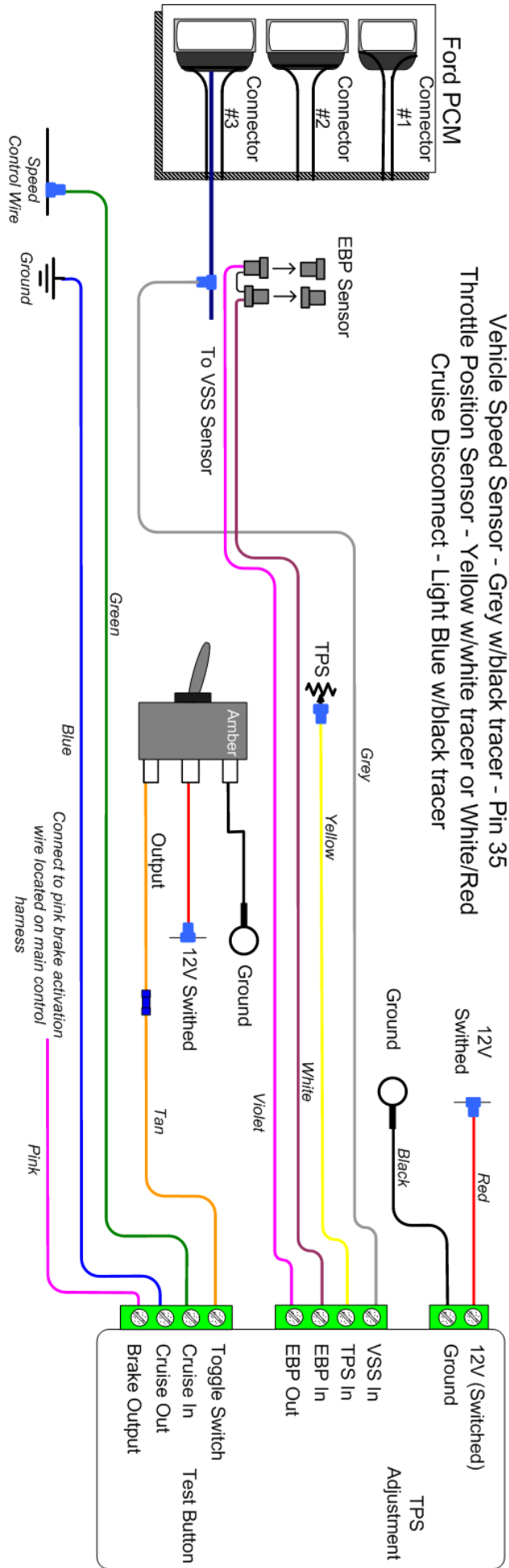

BD Engine Brake Inc.

Plant Address: 33541 MacLure Rd. Abbotsford, BC, Canada V2S 7W2

U.S. Shipping Address: 88-446 Harrison St, Sumas, WA 98295 U.S. Mailing Address: P.O. Box 231, Sumas, WA 98295

Phone: 604-853-6096 | Fax: 604-853-8749 | Internet: www.bd-power.com

## ***Control Module Calibration***

Ensure the connections of the corresponding wires to the control module are correct as shown in the wiring diagram.

The control module will have to be calibrated to your vehicles Throttle Position Sensor. While doing this you will need to hold down the Test button on the control module. The module is designed to disengage the brake below 15mph; the Test button simulates a Vehicle Speed (VSS) input so that the brake will engage with the vehicle stationary for testing & setup purposes. There is an LED inside the module which will light up whenever the module is powering the Brake Output wire to activate the brake; you will be able to see the LED through the case.

Start the engine and turn on the main toggle switch (or shifter switch) to arm the brake. With the throttle at idle, press the Test button and use a small, flat-bladed screwdriver to turn the small TPS adjustment screw on the right side of the control module clockwise or counterclockwise until the brake JUST turns on.

**CAUTION:** THE ADJUSTING SCREW IS A MICRO-SWITCH WHICH IS VERY DELICATE, SO TURN USING SMALL ADJUSTMENTS.

Test by holding the test button and revving up the engine to approximately 1000 RPM and releasing the throttle. As the accelerator pedal is applied, the LED should turn off and the exhaust brake should release just before the engine starts to rev, indicating proper calibration of the control module with the TPS.

The exhaust brake and LED should activate again when the throttle pedal returned to idle. If not, readjust the control module so that it does. Reinstall lower dash cover.

## ***Exhaust Brake Testing***

**Note** With automatic transmission vehicles, use Tow/Haul during exhaust brake use to improve holdback and ensure the coast clutch is engaged. To attain higher engine RPM, you may use the manual gear selections 3,2,1.

Start the vehicle and check for idle pressure. There is a 1/8" NPT port provided on the brake which you can attach your pressure gauge to.

The idle pressure should be preset at 10–15 lbs from the factory, so it should not need to be adjusted. If an adjustment is thought to be necessary, please go to the exhaust brake pressure testing section on page 24.

Take the vehicle for a test drive. The brake will only engage above 15 mph - it will not operate below this speed. Take the vehicle above this set speed, turn on the brake activation switch and let off of the throttle. The brake should apply and you should feel the vehicle slow down. Once 15 mph is reached, the brake will disengage automatically. Accelerate past the threshold speed once more, and let off the throttle once again. Re-apply the throttle and make sure the brake **quickly** disengages.

The brake must quickly disengage, if it does not, a PCM error code may be generated. Some common reasons for a slow reacting brake would be from the brake controller not being adjusted correctly, or the air solenoid valve being too far away from the brake.

While driving, turn on the cruise control, and then activate the brake. The activation of the brake should disconnect the cruise control. Turn the brake off and activate cruise control again, this time pressing down on the hydraulic brake pedal to ensure that the cruise control disconnects when the brake pedal is applied.

You may also notice that every time the vehicle is started, the exhaust brake is cycled for a 1/10<sup>th</sup> of second. This should help everything stay free and clear and reduce the possibility of the valve becoming jammed with carbon.

Next you will need to test the brake for maximum retarding pressure. You can either do this under load from a large hill or perhaps from letting off the throttle at a high RPM.

The regulated pressure is adjusted with the regulator on the control assembly and has been preset to allow a MAXIMUM of 45psi of exhaust back pressure. Note that you should try to attain this maximum pressure. See page 24 for detailed instructions on checking back pressure.

***CAUTION: Do NOT exceed 45 psi of back pressure.***

If you do not have a back pressure gauge, you can measure the voltage at the "EBP IN" pin of the control module. Under peak exhaust brake use (High Load & High RPM) you should see just below **4.0 Volts**.

BD Engine Brake Inc.

Plant Address: 33541 MacLure Rd. Abbotsford, BC, Canada V2S 7W2

U.S. Shipping Address: 88-446 Harrison St, Sumas, WA 98295 U.S. Mailing Address: P.O. Box 231, Sumas, WA 98295

Phone: 604-853-6096 | Fax: 604-853-8749 | Internet: [www.bd-power.com](http://www.bd-power.com)

**NOTE:** Over the next two weeks, the backpressure at idle may rise due to the initial carbon build up and the brake valve may need to be adjusted again.

Check for any exhaust leaks and re-check all connections and hoses for security and interference from moving or heated items. After about 100 miles (160 km), re-torque the exhaust v-band clamps.

**\*\*\* ATTENTION \*\*\***

**P0299 CODE:** If after installing the exhaust brake you receive a P0299 DTC, please set the APPS activation on the brake controller closer to idle. Also remove the small brass plug with a small hole in it from the back of the quick release valve on the exhaust brake air cylinder.

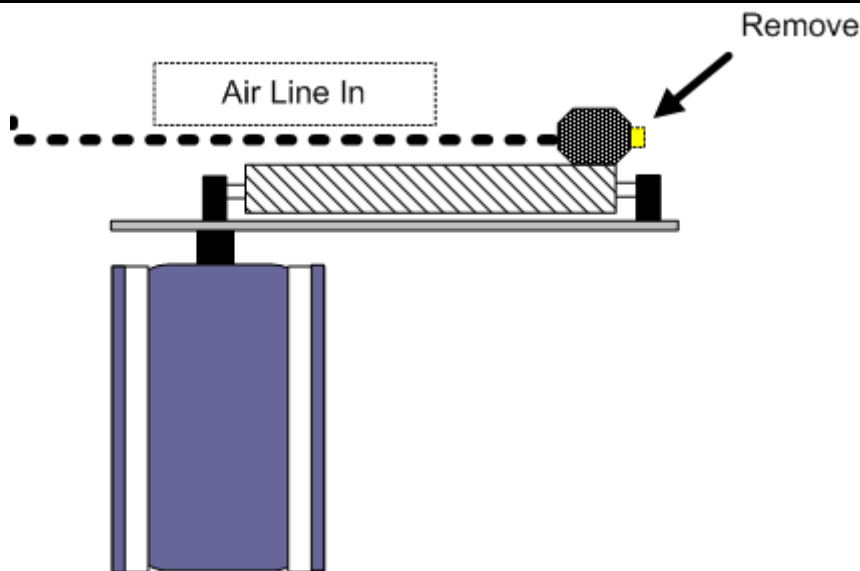

## Common Problems

**Brake cycles ON/OFF upon disengagement speed** – To cure this problem, a new ground should be found for the Brake Controller. Electrical noise on the ground and the VSS line cause this symptom.

**Brake does not activate** – Check all the wire connections and make sure that when the brake is supposed to be energized that 12V exists on the Brake output of the control module. Whenever the brake is supposed to be energized, a red LED should be lit inside of the brake controller. You can check this operation by pressing the test button on the side of the controller. Check to make sure that the TPS adjustment screw has been adjusted correctly and that the main switch is in the ON position and is providing 12V to the switch input.

**EBP & EGR DTC Codes** – First check to make sure the EBP wiring harness supplied is fully connected and there are no open connections. If these codes still exist please call a BD technician and they can instruct you how to adjust the EBP Out voltage.

BD Engine Brake Inc.

Plant Address: 33541 MacLure Rd. Abbotsford, BC, Canada V2S 7W2

U.S. Shipping Address: 88-446 Harrison St, Sumas, WA 98295 U.S. Mailing Address: P.O. Box 231, Sumas, WA 98295

Phone: 604-853-6096 | Fax: 604-853-8749 | Internet: [www.bd-power.com](http://www.bd-power.com)

## ***Exhaust Back Pressure Testing Air Actuated Brakes***

***It is recommend that you purchase the BD pressure gauge kit #1030050***



***NOTE: The brake stop-bolt and regulator have been preset at the factory and should not need to be adjusted.***

***You do not need to measure the air pressure in the system, just the exhaust backpressure, which is located on the cast valve.***



### **Idle Pressure Test**

With the BD brake engaged and the engine at idle check the exhaust backpressure using a pressure gauge (such as BD PN 1030050) at the test port on the brake valve.

If the back pressure is below 10 psi at idle you have a number of likely causes. The most common being an exhaust leak either at the clamp joint or at the welds (only on some models). Apply the exhaust brake and have someone assist you looking for soot trails or the visible leak. Another culprit would be an exhaust manifold leak, turbocharger gasket leak, turbocharger problem or an EGR issue.

If the back pressure is greater than 15psi, you will need to make an adjustment on the stop bolt. Loosen the jam nut, and lengthen the stop bolt towards the actuator, this will shorten the stroke distance. Only turn 1/4 rotation at a time and re-secure the jam nut. Retest idle pressure.

We generally do not recommend adjusting the stop bolt; please consult BD before doing this as incorrect adjustment can damage the valve and may void your warranty.

BD Engine Brake Inc.

Plant Address: 33541 MacLure Rd. Abbotsford, BC, Canada V2S 7W2

U.S. Shipping Address: 88-446 Harrison St, Sumas, WA 98295 U.S. Mailing Address: P.O. Box 231, Sumas, WA 98295

Phone: 604-853-6096 | Fax: 604-853-8749 | Internet: [www.bd-power.com](http://www.bd-power.com)



**Off-Idle Pressure Test & Adjustment**

Your BD exhaust brake is a variable-orifice design so when the brake is active and the engine is at higher RPM the brake lever does not rest on the stop bolt. Off-idle backpressure is set by adjusting the air pressure regulator which will in turn increase or decrease off-idle exhaust backpressure. You will need to secure your pressure gauge somewhere that you can see it while you are driving. Using a long extension hose & bringing the gauge into the cab through an open window or clipping it under a windshield wiper works well.

Get the truck up to speed (a downhill grade or a load in the truck is helpful) and activate the exhaust brake. Note the maximum backpressure achieved. You should get peak backpressure at higher RPM (try 3000 RPM in Drive). If you cannot reach the desired backpressure (compare table below) you can begin troubleshooting, the first step is to look for exhaust leaks either from the clamps, exhaust manifolds or feed pipes. Also look for leaks at the clamps located at the back of the turbo and also at the down pipe. If all connections are sealed, you can then use the adjusting regulator to increase the backpressure. Note that small regulator adjustments can have a significant effect on off-idle backpressure.

Turning the regulator **clockwise** will increase pressure.

Turning the regulator **counter clockwise** will decrease pressure.



**NOTE:** Over the next two weeks, the backpressure at idle may rise due to initial carbon build up on the inside of the brake housing and on the butterfly. The stop bolt may need to be adjusted again to compensate.

Application	Maximum Back Pressure
GM/Chevy 6.5	35 psi
GM/Chevy Duramax	55 psi
Ford Powerstroke	45 psi
Dodge Cummins 1988-98 12V w/o 60lbs Springs	40 psi
Dodge Cummins 1988-98 12V with 60lbs Springs	60 psi
Dodge Cummins 2002 and Newer	60 psi

\*HD Spring part# is 1030060.

**CAUTION:** Do NOT exceed the maximum back pressure value in the exhaust system. Exceeding this pressure will force the exhaust valves open during the intake stroke which could cause engine damage.

## Air Brake Troubleshooting Guide

This guide assumes that your exhaust brake system is using a DFIV and a BD air compressor. If your system uses a microswitch for throttle activation, the operation of the air solenoid and pump are the same as with the DFIV. If you are using existing on-board air, check that system as appropriate.

<b>When I let off the throttle nothing happens.</b>	<b><u>No</u></b>	<b><u>Yes</u></b>
Is the DFIV powering its "brake" output when the throttle is at idle and brake switch and ignition are both on?	<p>Check if DFIV has good power, ground and throttle signal. Check DFIV adjustment. If these things check out, but the DFIV won't power the "brake" output, the DFIV is likely faulty.</p> <p>Also check power &amp; ground at pump relay and make sure the air solenoid has a good ground.</p>	<p>Check that when air solenoid is powered it will allow air to flow from the #2 port out the #1 port.</p> <p>Check that pump relay is powering pump. If pump has power but does not run, pump is likely faulty. Check for power &amp; ground at pump relay, if these are good but relay does not click or does not power pump, relay is likely faulty.</p>
<b>The brake comes on but there's little or no holdback</b>	<b><u>No</u></b>	<b><u>Yes</u></b>
<p>See if torque converter is staying locked up during deceleration. If not, the engine RPM will fall to idle when the throttle is released. The brake will be ineffective without the torque converter locked up.</p> <p>Check off idle brake pressure. (See back pressure chart) Are you getting maximum allowable backpressure?</p>	<p>Check for exhaust leaks. A small leak can result in a significant decrease in back pressure. If no leaks are found try adjusting air regulator. Check for air leaks in brake system.</p>	<p>Try down shifting more aggressively. More RPM will give more holdback. Transmission or torque converter could be slipping internally.</p>
<b>Everything seems to work, but the brake valve won't close.</b>	<b><u>No</u></b>	<b><u>Yes</u></b>
Check that air is reaching brake air cylinder?	Air solenoid or quick release valve are likely stuck, plugged or faulty. Clean or replace as required.	Cylinder or brake valve are seized. Remove the clevis pin on the end of the cylinder rod & see if the valve lever can be moved freely.
The valve lever can be moved freely?	Try dismounting the brake & cleaning the carbon out of it. If this does not work the brake valve will need to be replaced.	The cylinder is stuck and will need to be replaced.
<b>Problem</b>	<b>Solution</b>	
Air compressor runs in short bursts and brake is slow to apply.	There is a restriction in the air system, normally in the regulator or air solenoid. Remove the fittings from the regulator and air solenoid, you will likely find some corrosion or debris caught in them. Clean this out with a pick, small brush, compressed air and WD40 or similar lubricant.	
Air compressor runs continually.	Pump relay is likely stuck on. Check operation of relay & replace as required.	
Brake is slow to release.	Debris or corrosion is restricting the quick release valve or air solenoid. Clean as required. Air solenoid could be too far from brake.	

Thank you and happy motoring,  
BD Engine Brake, Inc.