



**DOWNLOAD ENHANCED
INSTALL MANUALS AT
*dieselperformance.com***



BD Dodge Turbo Mount Exhaust Brake 2004½-07

Installation Instructions

BD P/N	Application
2023331	2004½-2005 Dodge Cummins
2023330	2006-2007 Dodge Cummins

Serial # _____

Date Purchased _____

Installed by _____

***** Please read this manual before starting installation. *****

OWNER'S MANUAL - LEAVE IN GLOVE BOX

The brake pressure at idle must be checked and adjusted at time of install, at least two weeks after install, and at regular twice a year intervals.

BD Engine Brake Inc.

Plant Address: 33541 MacLure Rd. Abbotsford, BC, Canada V2S 7W2

U.S. Shipping Address: 88-446 Harrison St, Sumas, WA 98295 U.S. Mailing Address: P.O. Box 231, Sumas, WA 98295



Phone: 604-853-6096 | Fax: 604-853-8749 | Internet: www.bd-power.com

Table of Contents



Kit Contents	3
Introduction.....	4
Optional Accessories	4
Notes on Connectors.....	4
Tools Required.....	5
Installation.....	5
Brake Valve Installation.....	5
Air Compressor Mounting Installation	6
Regulator Assembly Installation	8
Regulator Plumbing and Electrical	9
In-Cab Exhaust Brake Wiring (2006-07)	11
<i>ECM Activation Wire Install</i>	<i>11</i>
In-Cab Exhaust Brake Wiring (2004-05)	12
<i>DFIV Installation</i>	<i>12</i>
<i>Accelerator Pedal Position Sensor Wiring (2004)</i>	<i>12</i>
<i>Accelerator Pedal Position Sensor Wiring (2005)</i>	<i>14</i>
<i>Cruise Control Wiring (2004½-05).....</i>	<i>15</i>
Switch Install (Required if using main toggle switch)	16
<i>Attaching the switch relay (2006-07 Only)</i>	<i>18</i>
Optional Manual Shifter Switch (Push-Pull Style)	19
Optional Manual Shifter Switch (Rocker Switch Style)	19
Wiring & Plumbing Diagram (2004½-05)	21
Wiring & Plumbing Diagram (2006-07)	22
Using Main Toggle Switch Only	22
Using Push/Pull Shifter Switch (Manual Trans)	23
Using Rocker Switch (Manual Trans).....	24
DFIV Adjustment & Testing.....	25
DFIV Operation	25
Exhaust Back Pressure Testing for Air Actuated Brakes	26
Idle Pressure Test	26
Off-Idle Pressure Test & Adjustment.....	27
Maintenance	28
Air Brake Troubleshooting Guide.....	29

Kit Contents

Please check to make sure that you have received all parts for your kit

2123330-A	1030129-D	1300146
		
<p>Brake Valve Assembly</p>	<p>Compressor Assembly</p>	<p>1/8" Diameter Air Tubing</p>
<p>Qty: 1</p>	<p>Qty: 1</p>	<p>Qty: 3ft</p>

Kit 2023331 Only

1321039	1220139-A
	
<p>DFIV Controller and Wiring Kit</p>	<p>Regulator/Control Assy.</p>
<p>Qty: 1</p>	<p>Qty: 1</p>

Kit 2023330 Only

1321031	1220131-C
	
<p>Toggle Switch Kit</p>	<p>Regulator/Control Assy.</p>
<p>Qty: 1</p>	<p>Qty: 1</p>

BD Engine Brake Inc.

Plant Address: 33541 MacLure Rd. Abbotsford, BC, Canada V2S 7W2

U.S. Shipping Address: 88-446 Harrison St, Sumas, WA 98295 U.S. Mailing Address: P.O. Box 231, Sumas, WA 98295

Phone: 604-853-6096 | Fax: 604-853-8749 | Internet: www.bd-power.com

Introduction

Thank you for purchasing a BD Exhaust Brake.

This exhaust brake kit installs on the backside of the stock turbocharger. It requires either the stock turbocharger or a compatible aftermarket turbocharger be used. For vehicles where this will not be applicable, the BD Remote Mount exhaust brake may be used.

This manual is divided into different areas to assist you with the installation and operation of your braking unit. We strongly suggest that you write down the kit and serial numbers of your unit in the spaces provided and retain this manual for any future reference.

Optional Accessories

Description	Part #
Manual Transmission Shifter Switch Kit	1300210 or 1030900
AutoLoc Converter Lock-up Kit	1030390
Torqloc Converter Lock-up Kit	1030395
Performance BD Valve Body	CALL
Brake pressure gauge kit	1030050

Notes on Connectors

The kit includes a number of Posi-Tap™ connectors (Gray or Red/Black/Green or Yellow) to tap onto OEM wiring. It is important to select the correct color of connector so that it matches the gauge of the OEM wire that it is being installed on. Using the incorrect connector could cause an inadequate connection and/or the OEM wire could be severed.

OEM Wire	Posi-Tap™ Color
18-22ga	Gray or Red
12-18ga	Black
10-12ga	Green or Yellow

Though these connectors offer a quicker installation, the best option would be to solder the wires and isolate the joints with heat shrink or liquid electrical tape. Proper soldering techniques should be used to ensure adequate connections.

Posi-Tap™ Connector Usage Diagram

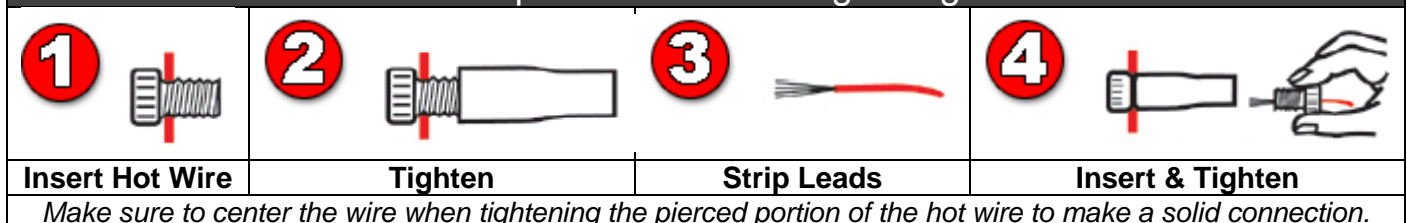

The ground terminals of the vehicle's batteries should be disconnected before performing any piercing/posi-tapping onto any ECM/PCM wire.

BD Engine Brake Inc.

Plant Address: 33541 MacLure Rd. Abbotsford, BC, Canada V2S 7W2

U.S. Shipping Address: 88-446 Harrison St, Sumas, WA 98295 U.S. Mailing Address: P.O. Box 231, Sumas, WA 98295

Phone: 604-853-6096 | Fax: 604-853-8749 | Internet: www.bd-power.com

Tools Required

- Measuring tape or ruler
- Drill with 1/8", 3/16" bits and Unibit
- Crimping Pliers
- Test light
- Socket Set
- Small bladed flat tip screwdriver

Installation

To prevent damage to electronic components, it is recommended that both battery negative terminals be disconnected while working on the vehicle.

Please read this manual thoroughly before installing this exhaust brake.



Raise and support the vehicle with a vehicle hoist or with appropriate jack stands.

Ensure vehicle is safely supported before proceeding to reduce possibility of damage or injury.

Brake Valve Installation

From underneath the vehicle, remove the down pipe-to-turbo elbow band clamp using a 10mm socket. Support the down pipe as it may drop down once the clamp is removed.

In the engine bay disconnect the intake air/pressure sensor harness behind the air filter and remove the plastic turbo air inlet tube. Loosen the band clamp that holds the factory exhaust elbow to the turbocharger and remove the exhaust elbow.

Insert the exhaust brake valve assembly in place of the factory elbow and reinstall the turbo band clamp.

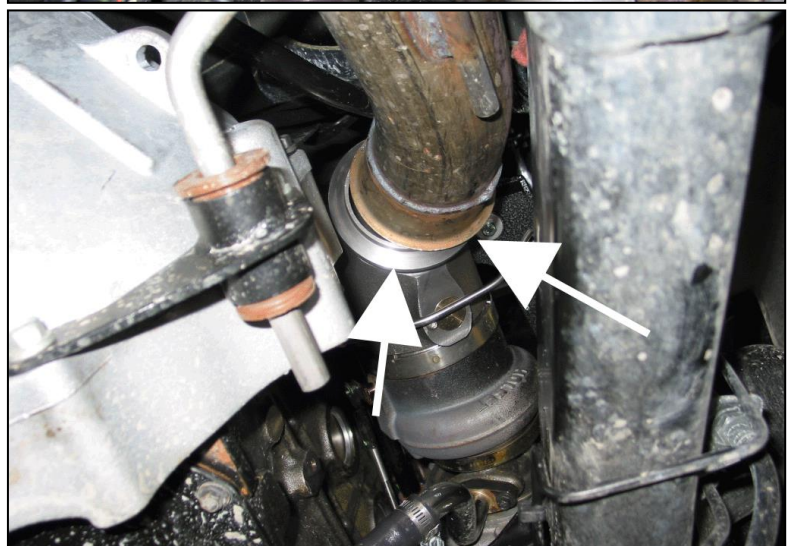
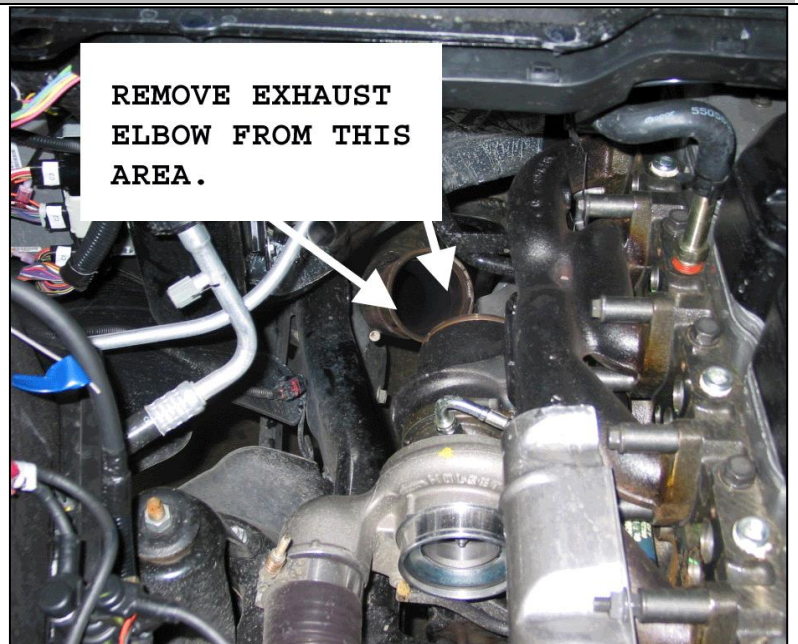

BD Engine Brake Inc.

Plant Address: 33541 MacLure Rd. Abbotsford, BC, Canada V2S 7W2

U.S. Shipping Address: 88-446 Harrison St, Sumas, WA 98295 U.S. Mailing Address: P.O. Box 231, Sumas, WA 98295

Phone: 604-853-6096 | Fax: 604-853-8749 | Internet: www.bd-power.com

Tighten all clamps that secure the brake to the flanges.

Make sure the exhaust brake bracket is at least 1" away from the exhaust manifold.

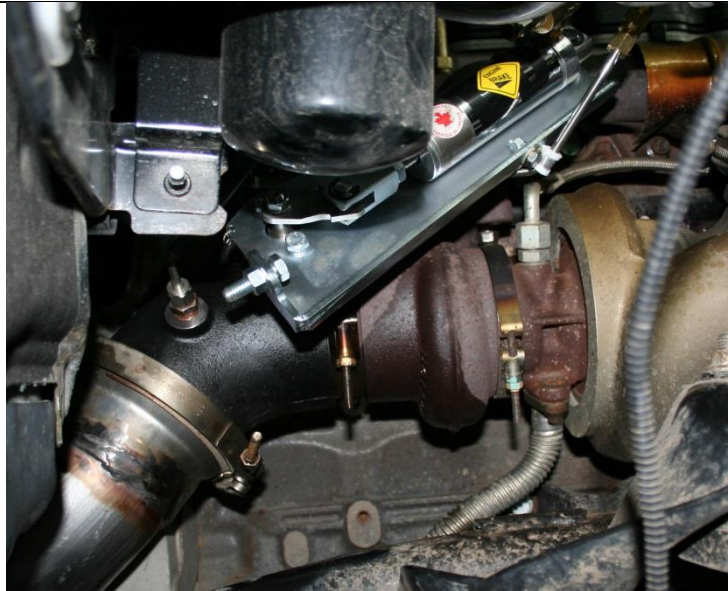

Air Compressor Mounting Installation

Remove the passenger side front wheel and remove the plastic fender liner from the vehicle to gain access to the inner fender area.

Install the supplied vibration dampening foam tape to the bottom back side of the compressor bracket assembly.



Locate the two mounting points for the compressor. The compressor bracket is designed to line up with the front hood hinge bolt and an existing hole in the inner fender. Remove the hood hinge bolt now to allow for installation of the compressor bracket.

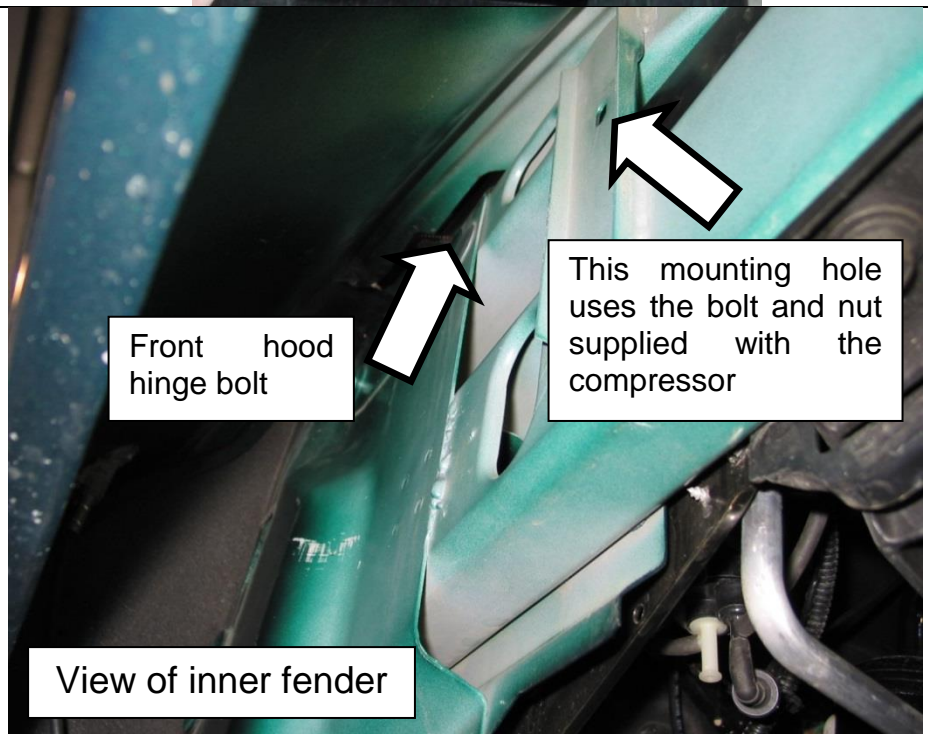

BD Engine Brake Inc.

Plant Address: 33541 MacLure Rd. Abbotsford, BC, Canada V2S 7W2

U.S. Shipping Address: 88-446 Harrison St, Sumas, WA 98295 U.S. Mailing Address: P.O. Box 231, Sumas, WA 98295

Phone: 604-853-6096 | Fax: 604-853-8749 | Internet: www.bd-power.com

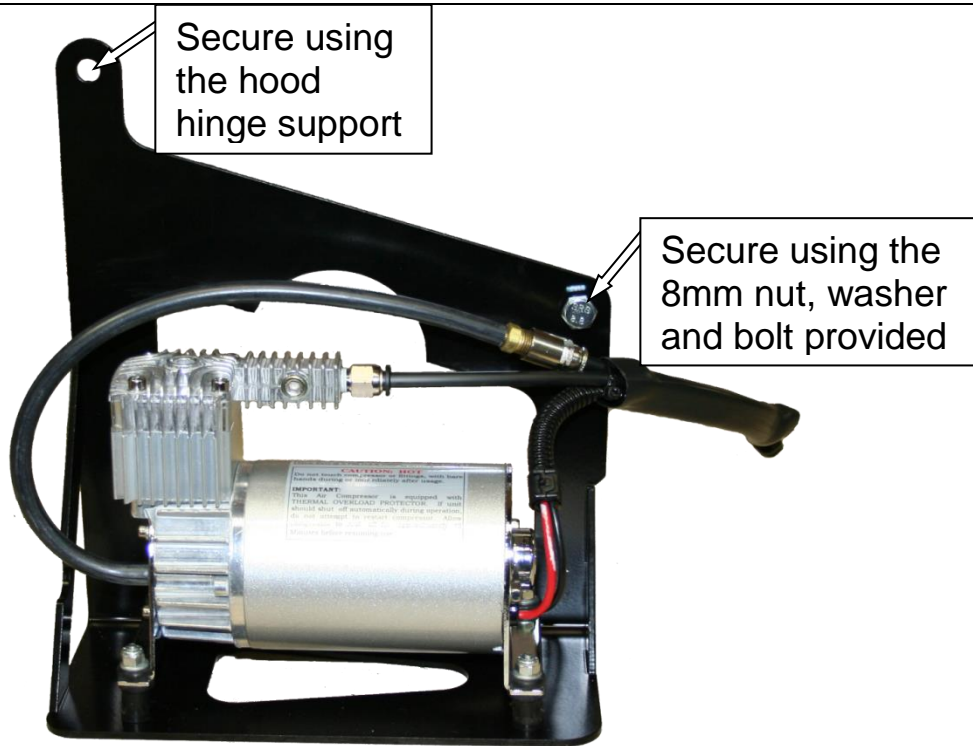

Feed the compressor air lines and wire through the fender into the engine bay, they will be connected later. Lift the compressor into place.



Secure the compressor in place by reinstalling the hood hinge bolt through the compressor bracket. Then install the nut and bolt to hold the front of the bracket.

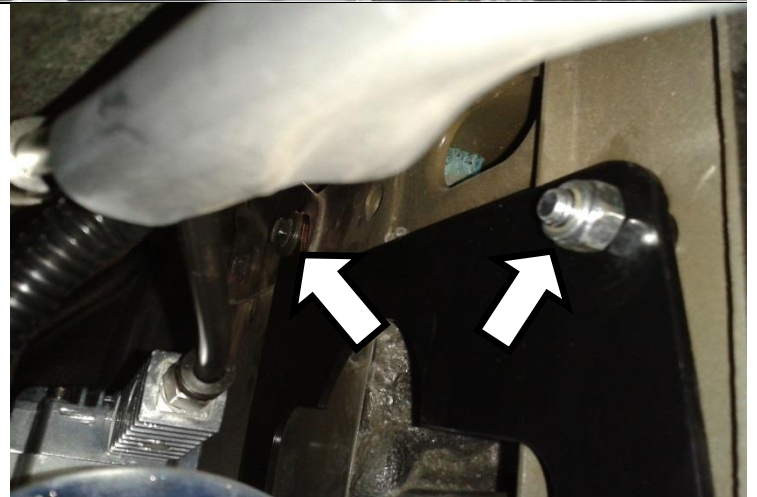

BD Engine Brake Inc.

Plant Address: 33541 MacLure Rd. Abbotsford, BC, Canada V2S 7W2

U.S. Shipping Address: 88-446 Harrison St, Sumas, WA 98295 U.S. Mailing Address: P.O. Box 231, Sumas, WA 98295

Phone: 604-853-6096 | Fax: 604-853-8749 | Internet: www.bd-power.com

Regulator Assembly Installation

The air pressure regulator assembly is to be mounted at the top of the firewall on the passenger side of the engine bay. The included washer should go directly under the head of the screw to sandwich the sheet metal against the regulator bracket.

Locate the large oval hole on the passenger side of the vehicle near the upper cowlings of the firewall. To the right of this you can either drill a 3/8" hole or use the existing hole by removing the factory plastic locking insert.

Install the regulator assembly underneath the hole (shown on figure to the right). The lock washer and flat washer should be installed on top of the plastic cowlings with the Phillips screw holding everything in place.

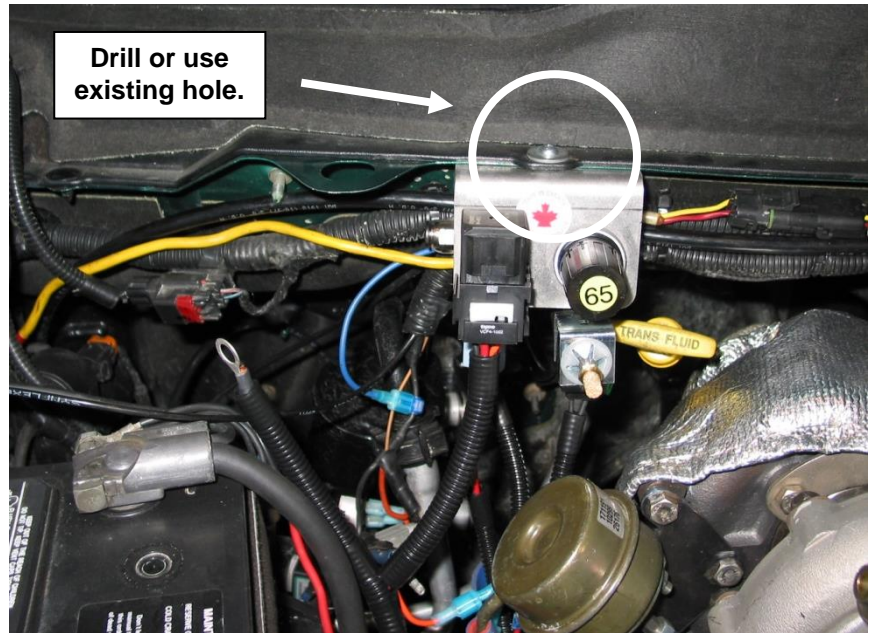

BD Engine Brake Inc.

Plant Address: 33541 MacLure Rd. Abbotsford, BC, Canada V2S 7W2

U.S. Shipping Address: 88-446 Harrison St, Sumas, WA 98295 U.S. Mailing Address: P.O. Box 231, Sumas, WA 98295

Phone: 604-853-6096 | Fax: 604-853-8749 | Internet: www.bd-power.com

Regulator Plumbing and Electrical

Connect the air pressure line from the pump to the inlet of the regulator assembly.

This is the shorter of the two 1/4" tubes from the compressor that does not have a fitting on the end. This connects to the passenger side of the regulator assembly, behind the relay.

Trim this tube to length and insert it into the fitting.

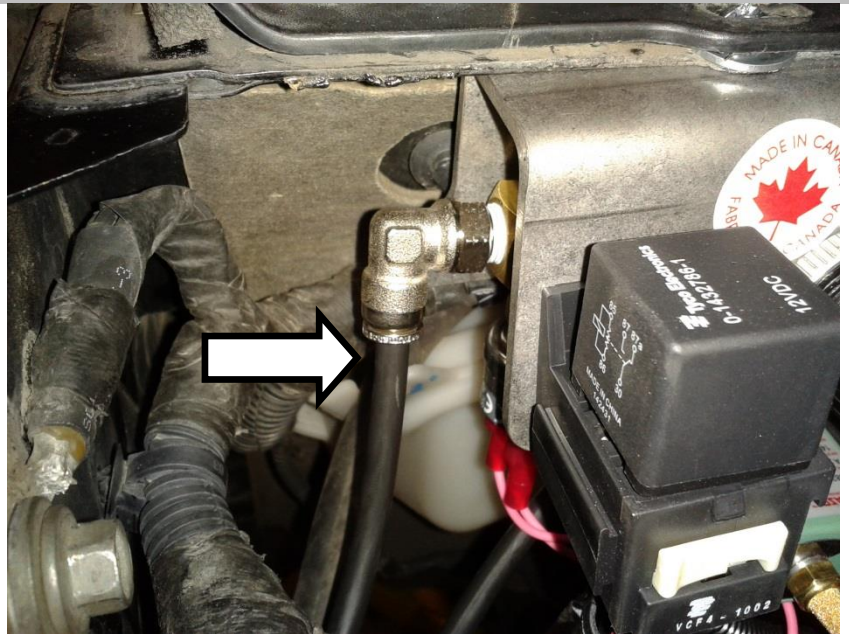

The other line of the compressor is the air suction line. This line is a 1/4" diameter and comes with a preinstalled threaded adapter. Install the threaded filter supplied with the air pump into this fitting.

The preferred method of mounting the compressor air filter is just below the hood using a factory mounting location for the sound deadening material.



Locate the 1/8" tube supplied with this kit. This will be installed in the output from the air regulator assembly on the bottom of the solenoid and routed to the inlet port of the exhaust brake air cylinder.

Trim this tube to length and install it in the 1/8" fitting.

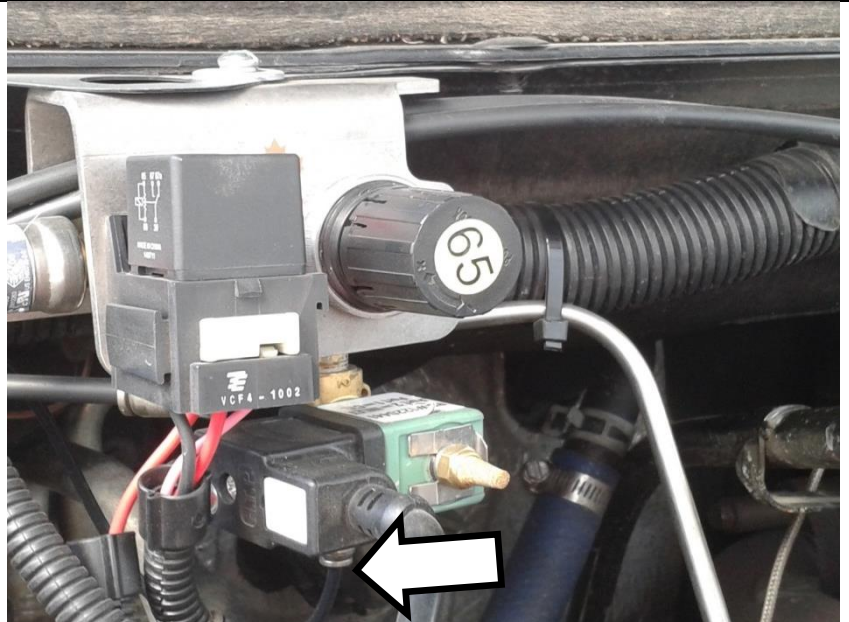

BD Engine Brake Inc.

Plant Address: 33541 MacLure Rd. Abbotsford, BC, Canada V2S 7W2

U.S. Shipping Address: 88-446 Harrison St, Sumas, WA 98295 U.S. Mailing Address: P.O. Box 231, Sumas, WA 98295

Phone: 604-853-6096 | Fax: 604-853-8749 | Internet: www.bd-power.com

Connect the main ground connection to the body ground on the passenger side of the engine bay near the regulator assembly.

This is the black wire with a ring terminal installed on the end.

Alternatively this may be connected directly to the battery negative terminal if desired.

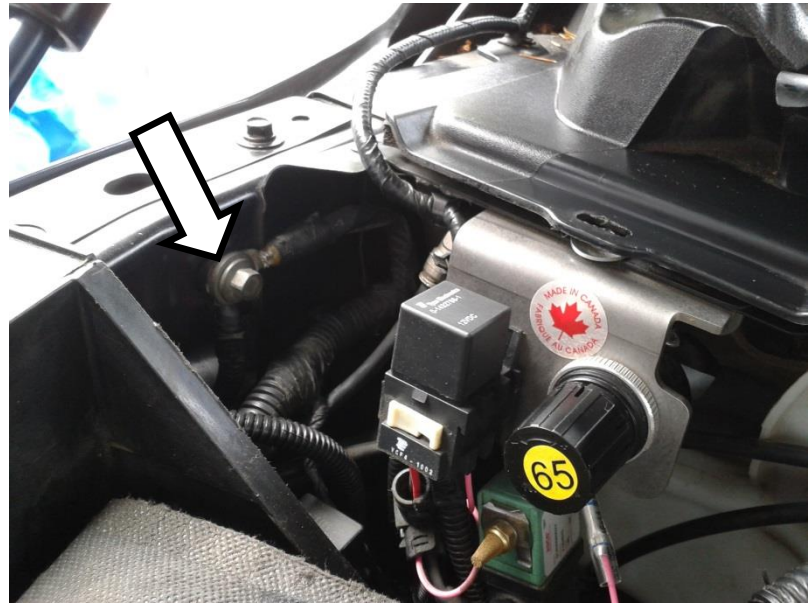

Connect the main power feed to the passenger side positive battery terminal clamp. This is the red wire with a ring terminal installed on the end.

Connect the two pin gray connector from the regulator assembly to the air compressor. Refer to the next section for the wiring of the DFIV control module or to the ECM and toggle switch. Refer to the wiring and plumbing diagram for more details.

BD Engine Brake Inc.

Plant Address: 33541 MacLure Rd. Abbotsford, BC, Canada V2S 7W2

U.S. Shipping Address: 88-446 Harrison St, Sumas, WA 98295 U.S. Mailing Address: P.O. Box 231, Sumas, WA 98295

Phone: 604-853-6096 | Fax: 604-853-8749 | Internet: www.bd-power.com

In-Cab Exhaust Brake Wiring (2006-07)

ECM Activation Wire Install

In-cab wiring has been made easier with the addition to Exhaust Brake programming through the Chrysler ECM for 2006-2007 model years. What used to take 4 wires and multiple OEM wire cutting has now been easily changed to two wire leads going to the ECM.

There are two separate ECM wiring blocks – one 60-pin connector and a 50-pin connector.

Remove the 50-pin connector (#3 on picture to the right).

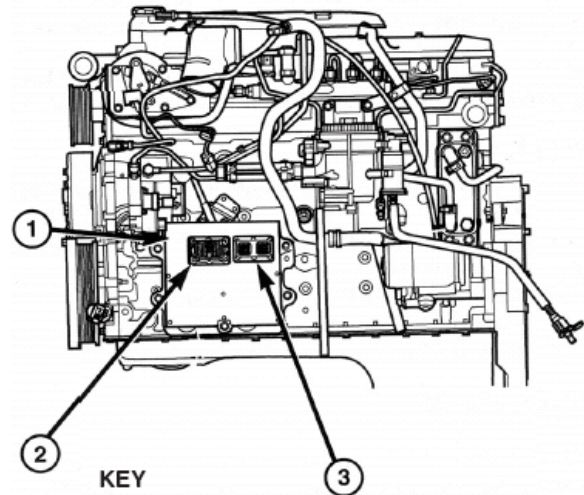

KEY
 1. Engine Control Module (ECM)
 2. 60-Way Connector
 3. 50-Way Connector

Locate Pin #39 (for the activation wire from the cab) and Pin #42 (for the black wire in the control harness). These pins have a plug in them from the factory. They will have to be removed.

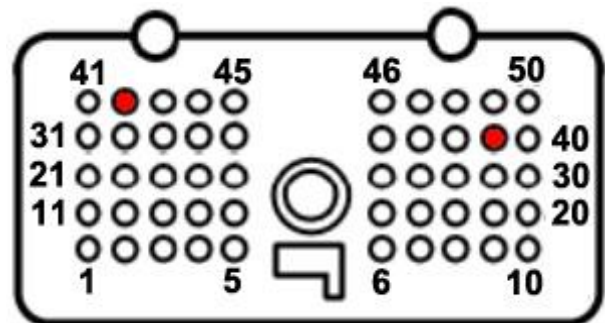

For this step you will need a pair of needle-nose pliers and a paper clip. Bend out the paper clip enough so that there is a straight shaft.

The easiest way to remove the OEM plug pins is to take the paper clip and insert it into the bottom end of the pin connector hole. This will poke out the top of the plug which then can be removed with pliers.

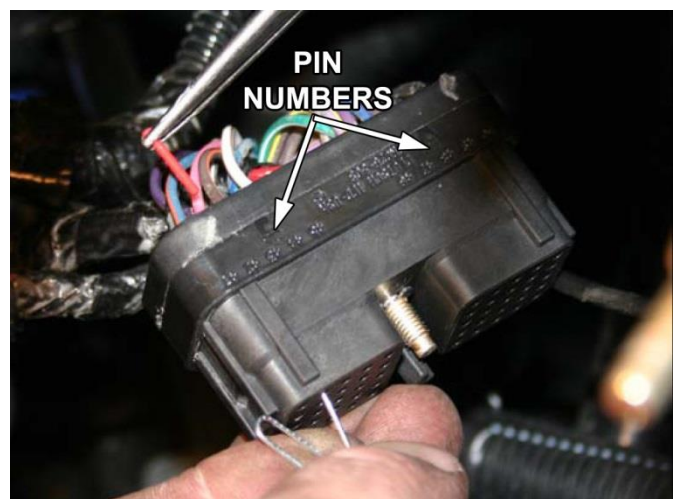

The two wire leads from the exhaust brake control harness (with the ECM pins pre-crimped) can now be plugged into the ECM. Insert the tan wire into Pin #39, and the black wire to Pin #42. They should snap into place. Once this is complete, you can re-install the ECM plug. Secure the wiring loom using the supplied tie wraps.

BD Engine Brake Inc.

Plant Address: 33541 MacLure Rd. Abbotsford, BC, Canada V2S 7W2

U.S. Shipping Address: 88-446 Harrison St, Sumas, WA 98295 U.S. Mailing Address: P.O. Box 231, Sumas, WA 98295

Phone: 604-853-6096 | Fax: 604-853-8749 | Internet: www.bd-power.com

In-Cab Exhaust Brake Wiring (2004-05)

DFIV Installation

If your truck is a 2006 or 2007 you do not need to install a DFIV module as this function is built into the trucks factory programming. Skip ahead to page 22 for 06-07 ECM wiring.

Mount the DFIV module in a secure location under the dash using the cable ties provided. Locate a grommet on the firewall and cut an opening in it to run the wiring through the firewall. Route the pink and yellow wires (for 2004) or just the pink wire (for 2005) through the firewall into the engine bay. Crimp the pink DFIV wire to the pink wire from the regulator & relay assembly, using the crimp connector with the clear plastic heatshrink. The yellow wire will be hooked up later.

Attach the black ground wire to the "Gnd" terminal on the DFIV and attach the ring terminal to a good ground.

Locate a grommet on the firewall and cut an opening in it to run the loom covered wiring through the firewall.

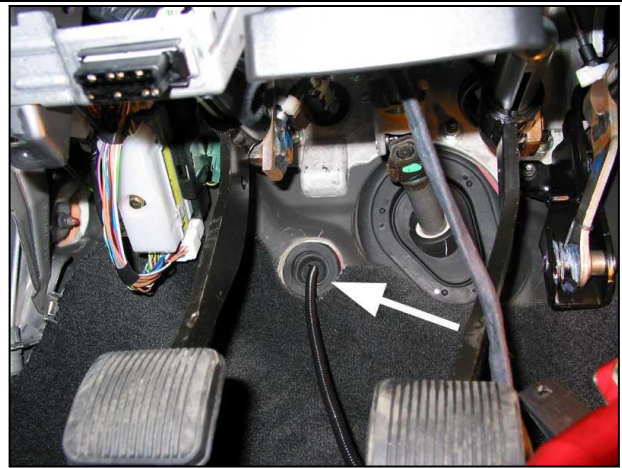

Accelerator Pedal Position Sensor Wiring (2004)

There are two possible locations to tap into the accelerator pedal sensor wiring, at the sensor itself or at the ECM. A posi-tap has been included with the DFIV installation kit and may be used to connect to this wire, however soldering this connection is recommended for longevity.

If connecting at the sensor, route the yellow wire in the DFIV kit from the DFIV module to the accelerator pedal sensor mounted either on the side of the engine under a protective cover or beneath the driver's side battery tray depending on model and transmission. See table below for wire colors and location. Once this connection is made, reconnect the APPS electrical connector and reinstall the throttle linkage cover.

If connecting at the ECM, refer to the table below for the appropriate wire color and pin location.

BD Engine Brake Inc.

Plant Address: 33541 MacLure Rd. Abbotsford, BC, Canada V2S 7W2

U.S. Shipping Address: 88-446 Harrison St, Sumas, WA 98295 U.S. Mailing Address: P.O. Box 231, Sumas, WA 98295

Phone: 604-853-6096 | Fax: 604-853-8749 | Internet: www.bd-power.com

Application	Sensor Location	Sensor Pin/Wire Color	ECM Pin/Wire Color
2004 Automatic	Engine	APPS Pin 3 – BR/WT	ECM C1 Pin 14 – BR/WT
2004 Manual	Battery Tray	APPS Pin 5 – BR/WT	ECM C1 Pin 14 – DB/WT

NOTE: 2004 Manual transmission trucks change the wire color between the sensor and ECM.

Engine Mounted APPS

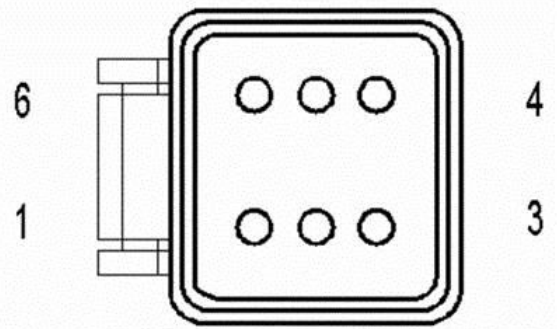
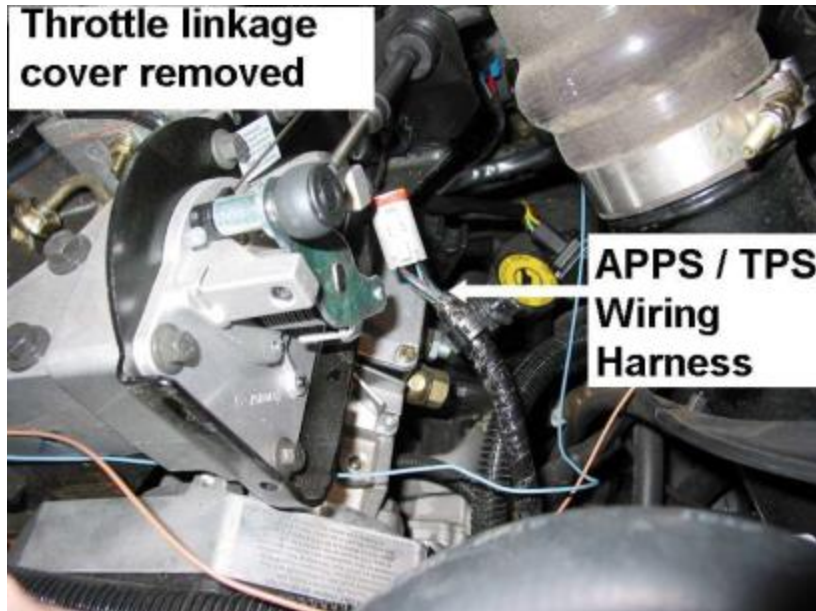

Battery Tray Mounted APPS

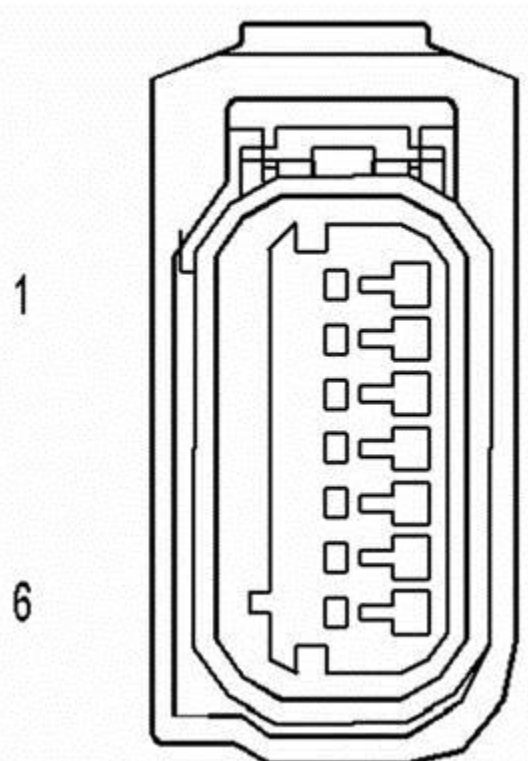

2003-2004 ECM Connector

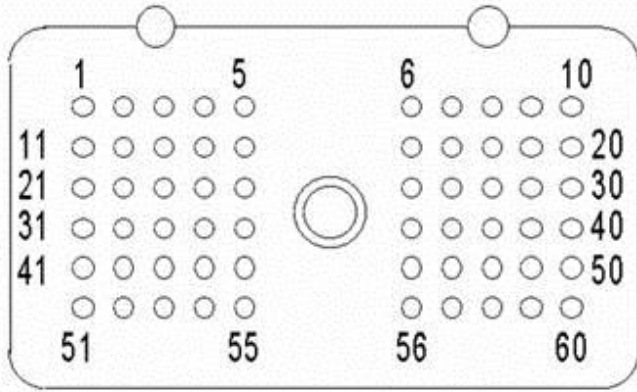

**ENGINE CONTROL
MODULE C1**

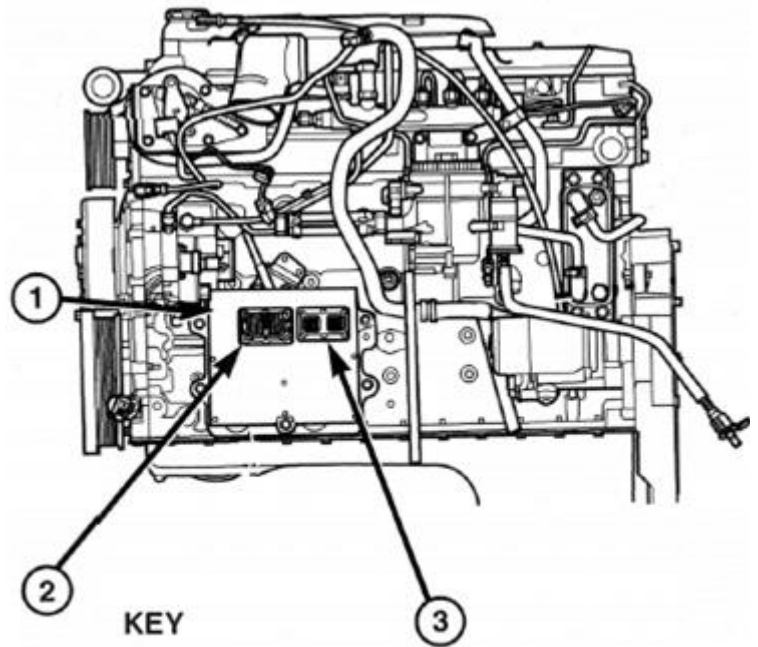

- KEY**
- 1. Engine Control Module (ECM)
 - 2. 60-Way Connector
 - 3. 50-Way Connector

Accelerator Pedal Position Sensor Wiring (2005)

Route the **yellow** wire from the apps terminal of the DFIV module to the accelerator pedal position sensor located on the accelerator pedal. Use the posi-tap to connect the yellow wire to the factory wire indicated below.

APPS Location (Accelerator Pedal)	APPS Plug

ECM Plug Pin	Circuit / Wire Color	Function
5	K23 20BR/WT	APPS NO. 1 SIGNAL

Cruise Control Wiring (2004½-05)

To obtain access to the Cruise Control wiring harness remove the lower steering column panel by removing the mounting screws and unsnapping the panel from the instrument panel.

Under the dash running vertical by the left of the steering column, locate the smaller wiring harness that runs out of the main harness.

Remove some of the black electrical tape to gain access to the smaller wire bundle.

*****DANGER*****

THERE ARE 2 SETS OF TWISTED PAIR LIGHT GREEN WITH TRACER WIRES IN THIS WIRE BUNDLE. DO NOT CONNECT OR TEST THESE WIRES AS THEY ARE CONNECTED TO THE AIR BAG SYSTEM AND THE BAG MAY DEPLOY CAUSING DAMAGE AND/OR INJURY!

Remove some of the black electrical tape from the small bundle to gain access to the small **violet** wire and install a gray Posi-Tap to it. Insert the **blue** wire from the “Dodge” terminal of the DFIV module into this connector.

In this same wiring harness, locate the **violet w/ Brown tracer** wire and install another gray Posi-Tap. Insert the **green** wire from the “Com” terminal of the DFIV module into this connector.



	Cruise Wires	DFIV
2004½ - 05 Dodge	Violet	Blue Wire – “Dodge” Input
2004½ - 05 Dodge	Violet w/ Brown	Green Wire – “Com” Input

Switch Install (Required if using main toggle switch)

If you wish to use an optional shifter mounted switch skip this step. See pages 19 to 19 for shifter switch install.

Remove attaching screws of the dashboard bezel and remove covering trim by pulling rearward on the corners of the trim panels.

Note: Placing the transmission all the way into 1st/low gear and ensuring the tilt steering is all the way down will allow for easy removal.



Pull the left hand and right hand dash panels away from their secured positions and let them hang.

Once the dash trim has been removed place it on a large working surface like a table or workbench.

Measure and mark a spot for the Toggle Switch 3/4" up from the bottom edge of the dash panel and 1" in from the left edge of the accessory panel as shown in the photo.



Drill a pilot hole with a 1/8" bit and finish by enlarging the hole with a Unibit to exactly 1/2".

NOTE: YOU MAY HAVE TO GRIND DOWN PART OF THE SUPPORT RIB ON THE BACK OF THE TRIM PANEL TO ACCOMMODATE THE SWITCH BODY.

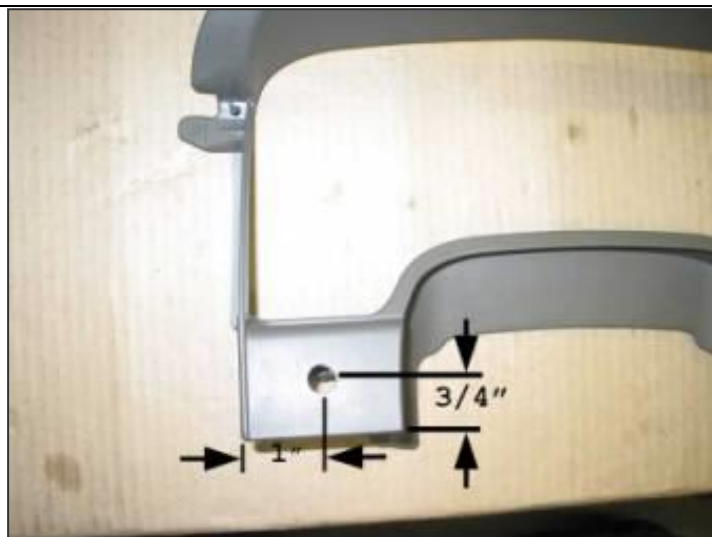

BD Engine Brake Inc.

Plant Address: 33541 MacLure Rd. Abbotsford, BC, Canada V2S 7W2

U.S. Shipping Address: 88-446 Harrison St, Sumas, WA 98295 U.S. Mailing Address: P.O. Box 231, Sumas, WA 98295

Phone: 604-853-6096 | Fax: 604-853-8749 | Internet: www.bd-power.com



Install the switch into the drilled hole and secure it with the plastic lock ring. Reinstall the dash trim panels by reversing the removal procedure.

Once the switch is installed, attach the ground wire to a good metal ground under the dash.

With a test light, locate a switched 12 Volt power source (quite frequently a pink w/ white tracer wire) and install the supplied black (12-18ga) Posi-Tap™ to it then attach the red fused wire from the switch to this Posi-Tap™.

On 2004-2005 trucks connect the remaining switch wire to the "Switch" terminal on the DFIV. On 2006-2007 trucks it will be connected to the under-dash relay assembly (see following page).

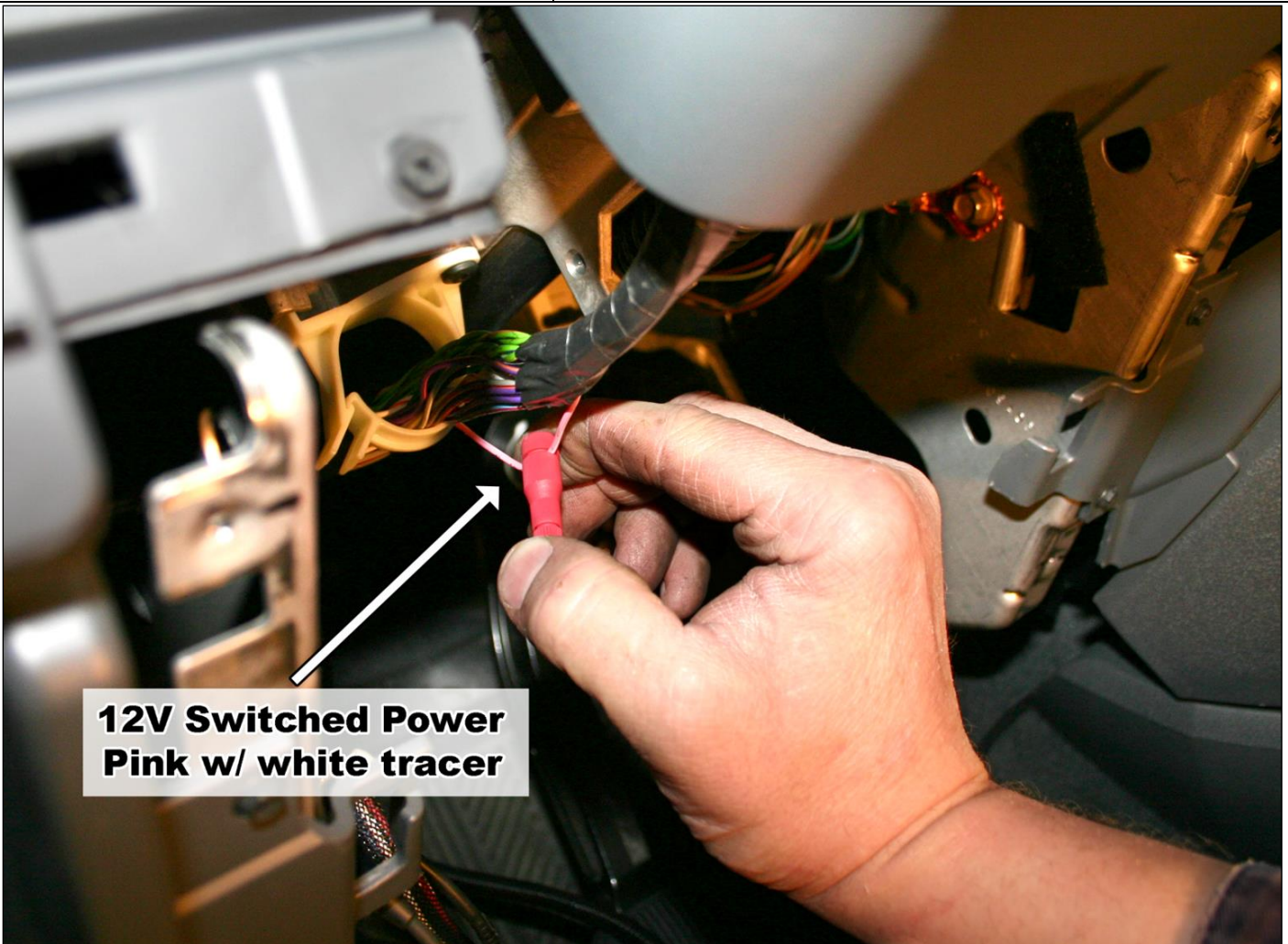

**12V Switched Power
Pink w/ white tracer**

BD Engine Brake Inc.

Plant Address: 33541 MacLure Rd. Abbotsford, BC, Canada V2S 7W2

U.S. Shipping Address: 88-446 Harrison St, Sumas, WA 98295 U.S. Mailing Address: P.O. Box 231, Sumas, WA 98295

Phone: 604-853-6096 | Fax: 604-853-8749 | Internet: www.bd-power.com

Attaching the switch relay (2006-07 Only)

Due to the characteristics of running the exhaust brake controls through the ECM, a relay kit has to be installed (unless you are installing the push-pull switch for the manual transmissions). This is so the light on the toggle switch (or rocker switch for the manual transmissions) can be lit while the exhaust brake is engaged. This relay comes pre-wired from the factory and is included in the main toggle switch kit.

Connect the tan wire coming from the ECM to terminal #87 on the relay. Connect the green wire leading from the switch to terminal #85 on the relay. Connect the black Y-wire to a ground source nearby. Blade terminals have been included loose in the bag, but not pre-crimped, so you can strip the wire to the desired length.

Wiring With The Default Toggle Switch (2006-07 Only)

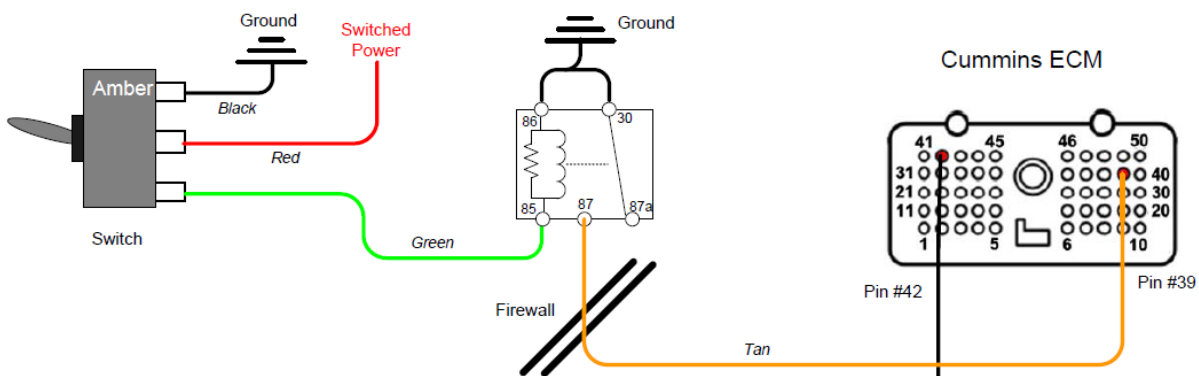

Wiring With The Rocker Switch (Manual Trans) (2006-07 Only)

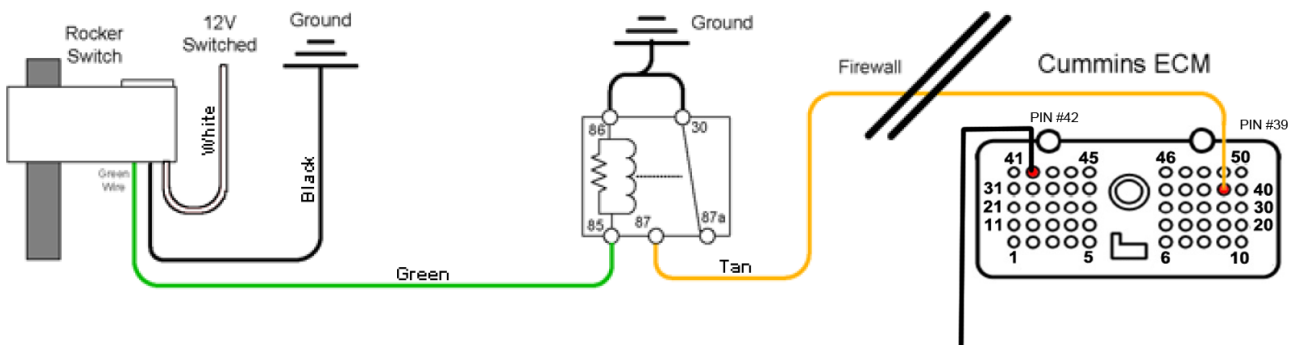

This switch relay is **not required** when wiring the exhaust brake with the push-pull style switch.

Optional Manual Shifter Switch (Push-Pull Style)

Mount the shifter switch onto the shift lever using the clamp supplied (either 5/8" or 3/4").

Run the electrical cable down the shifter shaft, securing the cable with zip-ties or electrical tape, and run it under the carpet to the firewall and under the dash, leaving enough slack for proper shifting of the transmission lever and to prevent any rubbing of wire.

At the end of the cable, cut off any excess and strip away about 1 to 2 inches of the black rubber covering exposing the black and white (or green) wires, and then strip the insulation from the ends of the two wires.



Connect the white (or green) wire to the Tan brake activation wire leading to the ECM. Connect the black wire to a nearby ground source.

Optional Manual Shifter Switch (Rocker Switch Style)

BD Engine Brake Inc.

Plant Address: 33541 MacLure Rd. Abbotsford, BC, Canada V2S 7W2

U.S. Shipping Address: 88-446 Harrison St, Sumas, WA 98295 U.S. Mailing Address: P.O. Box 231, Sumas, WA 98295

Phone: 604-853-6096 | Fax: 604-853-8749 | Internet: www.bd-power.com

Mount the shifter switch onto the shift lever using the clamp supplied (either 5/8" or 3/4"). Run the electrical cable down the shifter shaft, securing the cable with zip-

ties or electrical tape, and run it under the carpet to the firewall and under the dash, leaving enough slack for proper shifting of the transmission lever and to prevent any rubbing of wire.

At the end of the cable, cut off any excess and strip away about 1-2" of the black rubber insulation exposing the black, white and green wires, then strip the insulation from the ends of the three wires.

Connect the green 12V output green wire to #85 on the switch relay, which then leads to the Tan brake activation wire going to the ECM.

Attach the 5/16" ring connector to the black ground wire and attach it to a good ground nearby.

Locate one of the ignition switched power fuses in the fuse panel underneath the steering column. Traditionally this wire will be pink with a white tracer. Use a voltmeter to check the voltage of the wire. Use the supplied fuse tap to supply ignition switched power to the "Keyed 12 Volts" (white) wire of the rocker switch assembly.

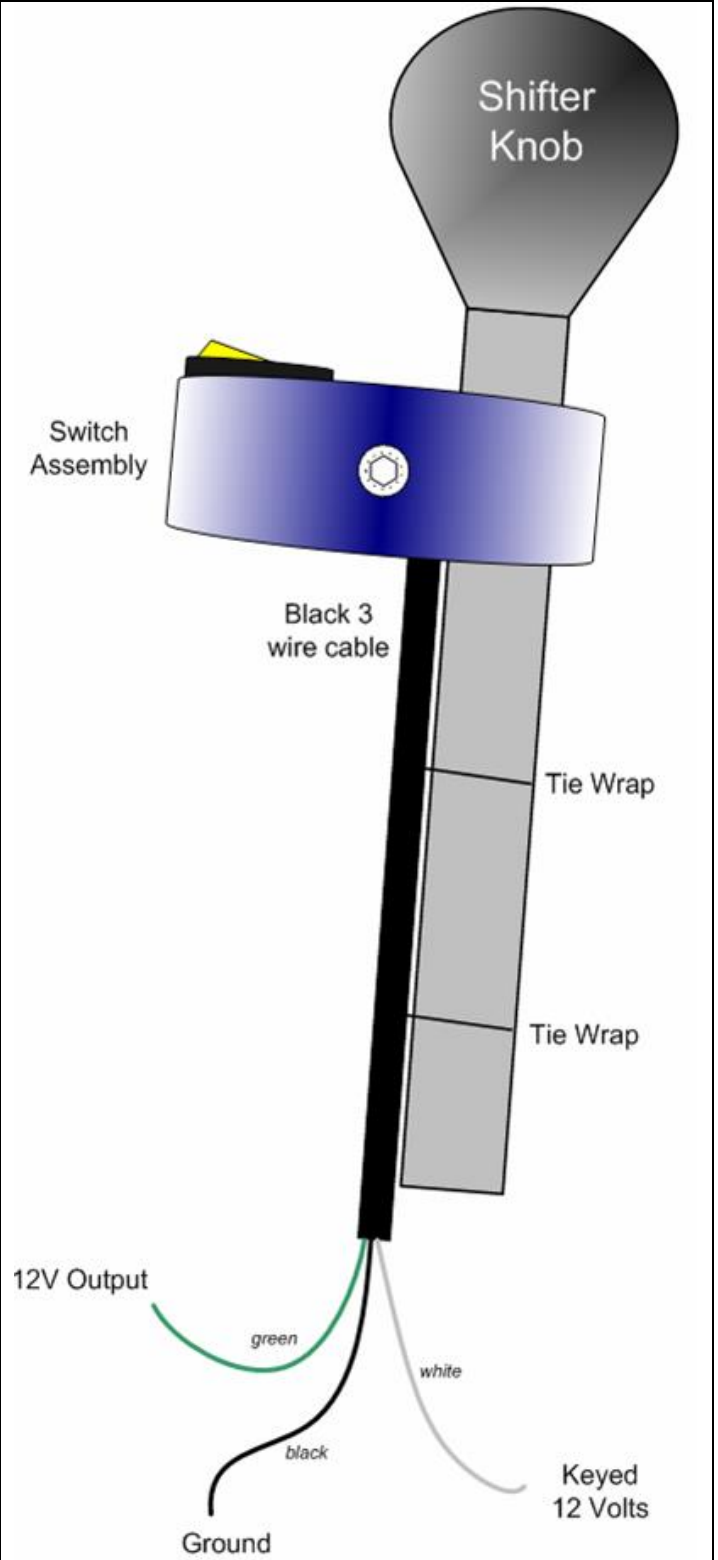

Wiring & Plumbing Diagram (2004½-05)

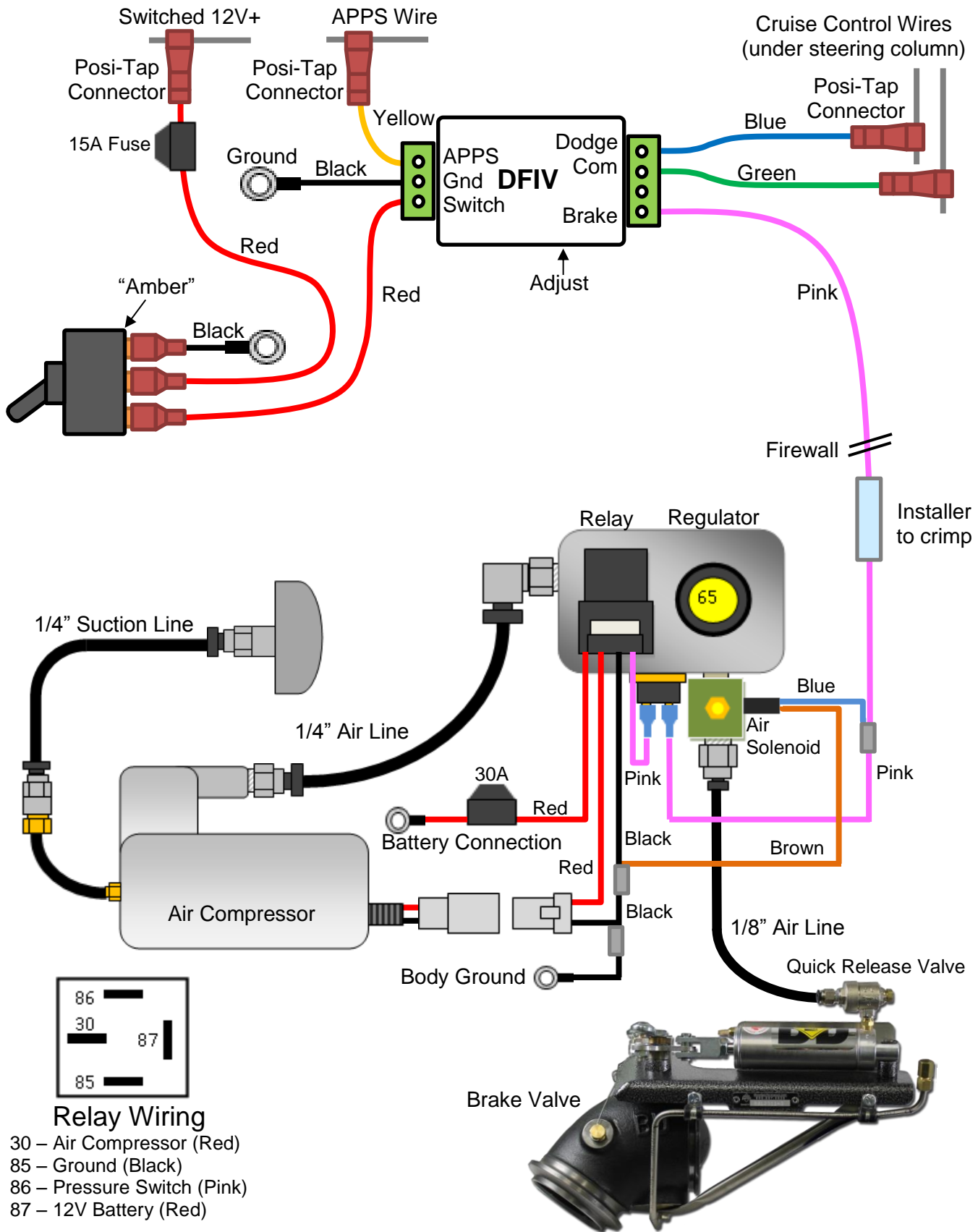

BD Engine Brake Inc.

Plant Address: 33541 MacLure Rd. Abbotsford, BC, Canada V2S 7W2

U.S. Shipping Address: 88-446 Harrison St, Sumas, WA 98295 U.S. Mailing Address: P.O. Box 231, Sumas, WA 98295

Phone: 604-853-6096 | Fax: 604-853-8749 | Internet: www.bd-power.com

Wiring & Plumbing Diagram (2006-07)

Using Main Toggle Switch Only

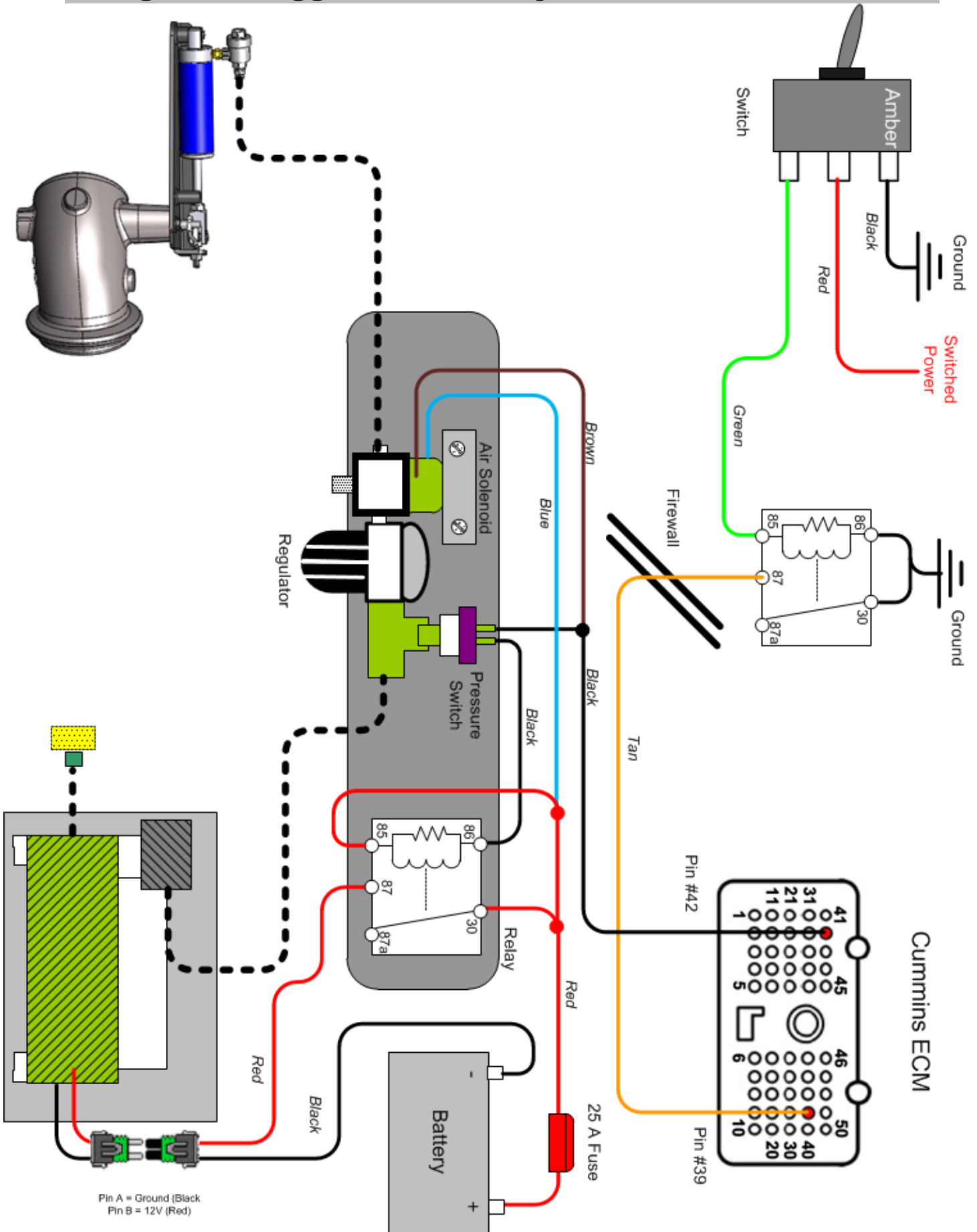

BD Engine Brake Inc.

Plant Address: 33541 MacLure Rd. Abbotsford, BC, Canada V2S 7W2

U.S. Shipping Address: 88-446 Harrison St, Sumas, WA 98295 U.S. Mailing Address: P.O. Box 231, Sumas, WA 98295

Phone: 604-853-6096 | Fax: 604-853-8749 | Internet: www.bd-power.com

Using Push/Pull Shifter Switch (Manual Trans)

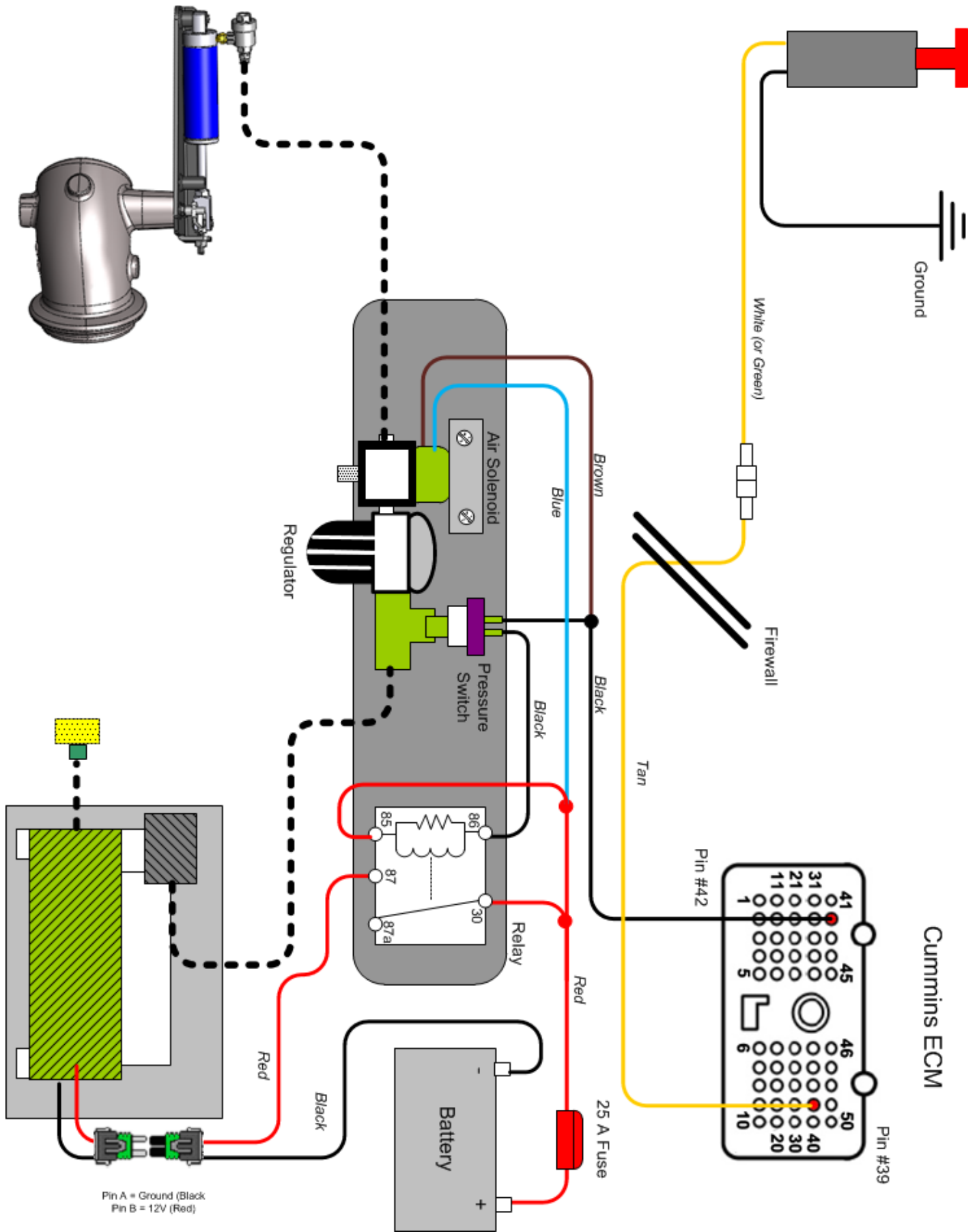

BD Engine Brake Inc.

Plant Address: 33541 MacLure Rd. Abbotsford, BC, Canada V2S 7W2

U.S. Shipping Address: 88-446 Harrison St, Sumas, WA 98295 U.S. Mailing Address: P.O. Box 231, Sumas, WA 98295

Phone: 604-853-6096 | Fax: 604-853-8749 | Internet: www.bd-power.com

Using Rocker Switch (Manual Trans)

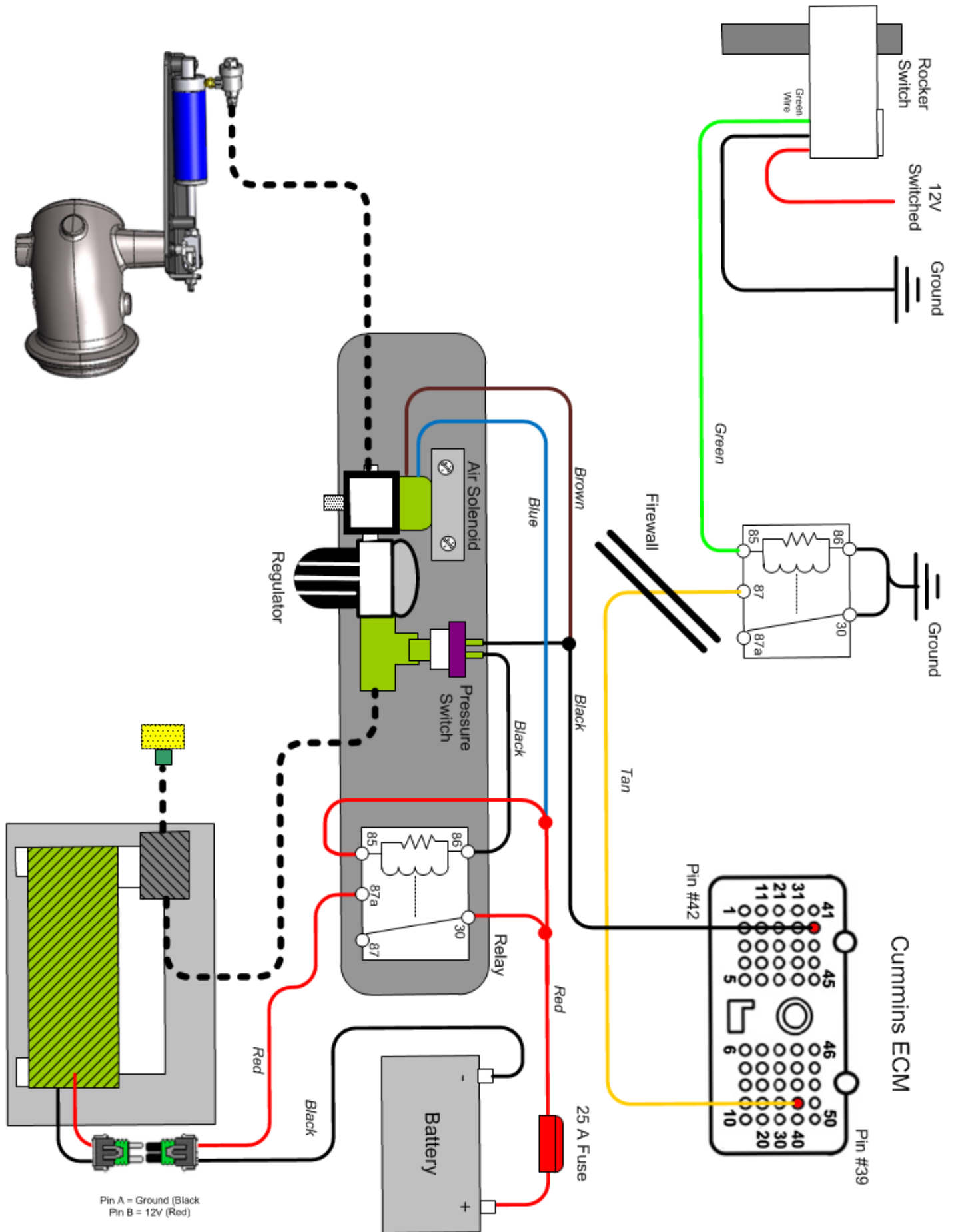

BD Engine Brake Inc.

Plant Address: 33541 MacLure Rd. Abbotsford, BC, Canada V2S 7W2

U.S. Shipping Address: 88-446 Harrison St, Sumas, WA 98295 U.S. Mailing Address: P.O. Box 231, Sumas, WA 98295

Phone: 604-853-6096 | Fax: 604-853-8749 | Internet: www.bd-power.com

DFIV Adjustment & Testing

To achieve the correct setting for the activation of the exhaust brake in relation to the throttle pedal the DFIV Module must be calibrated for your vehicle.

Connect one end of a test light to the "BRAKE" terminal of the DFIV module and the other end to a good ground.

With the throttle at idle, turn the key to run and turn on toggle switch (switch should light up). Then, using a small flat bladed screwdriver, turn the small adjusting screw in the DFIV Module counterclockwise or clockwise until the test light JUST turns on.



CAUTION: THE ADJUSTING SCREW IS A MICRO-SWITCH THAT IS VERY DELICATE, SO TURN USING SMALL ADJUSTMENTS

As the accelerator pedal is applied the test light should turn off just as the throttle comes off idle, indicating proper calibration of the DFIV Module with the APPS.

Then the test light should activate again when the throttle pedal returned to idle. If not, readjust the DFIV Module so that it does.

DFIV Operation

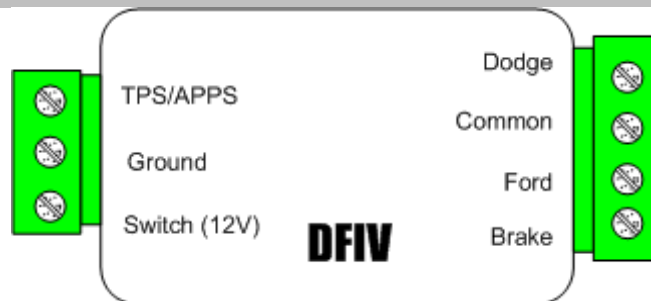

Input	Description
TPS/APPS	Locate the TPS/APPS wire from the Accelerator pedal position assembly. This wire is referred to as sensor circuit #1 on the rising signal circuit, and should rise linearly in voltage with the amount of throttle depressed. Typical values range from 0.5 Volts and rise to 4.5 Volts.
Ground	Connect to Vehicle electrical ground
Switch (12V)	This connection will supply 12 volt power to the DFIV. This will come from the toggle or shifter switch.
Dodge	This input should only be used for Dodge applications as it disables the cruise control specifically for Dodge trucks.
Common	Common cruise inputs between the Dodge and Ford inputs.
Ford	This input can be used for other generic applications. When the brake is activated the connection between the Ford input and the Common is severed.
Brake	You should have 12 volts at this terminal when the key is in "run", the brake switch is on and the throttle is at idle. There should be no power at this terminal if any of those conditions are not met.

Exhaust Back Pressure Testing for Air Actuated Brakes

To test exhaust brake system pressure, a minimum 0-100psi pressure gauge is required.

We recommend purchase of a BD brake pressure gauge kit #1030050.

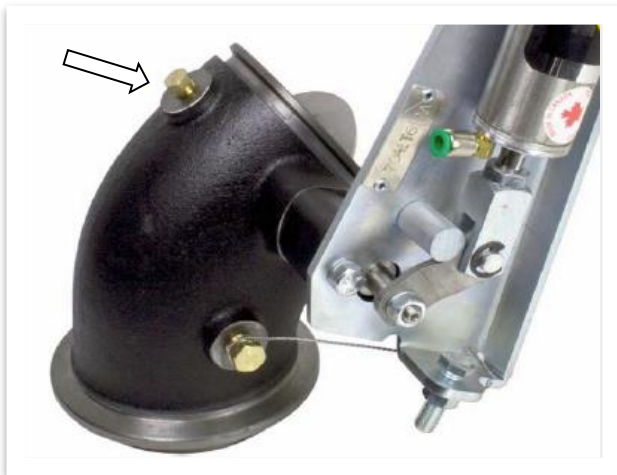

You do not need to measure the air pressure in the system, just the exhaust backpressure, which is located on the cast valve.

Idle Pressure Test

With the BD brake engaged and the engine at idle check the exhaust backpressure using a pressure gauge (such as BD PN 1030050) at the test port on the brake valve.

If the back pressure is below 13 psi at idle you have a number of likely causes. The most common being an exhaust leak either at the clamp joint or at the welds (only on some models). Apply the exhaust brake and have someone assist you looking for soot trails or the visible leak. Another culprit would be an exhaust manifold leak, turbocharger gasket leak, turbocharger problem or an EGR issue.

If the back pressure is greater than 25psi, you will need to make an adjustment on the stop bolt. Loosen the jam nut, and lengthen the stop bolt towards the actuator, this will shorten the stroke distance. Only turn 1/4 rotation at a time and re-secure the jam nut. Retest idle pressure.

NOTE: The brake stop-bolt and regulator have been preset at the factory and should not need to be adjusted.

We generally do not recommend adjusting the stop bolt, please consult BD before doing this as it may void your warranty.

BD Engine Brake Inc.

Plant Address: 33541 MacLure Rd. Abbotsford, BC, Canada V2S 7W2

U.S. Shipping Address: 88-446 Harrison St, Sumas, WA 98295 U.S. Mailing Address: P.O. Box 231, Sumas, WA 98295

Phone: 604-853-6096 | Fax: 604-853-8749 | Internet: www.bd-power.com

Off-Idle Pressure Test & Adjustment

Your BD exhaust brake is a variable-orifice design so when the brake is active and the engine is at higher RPM the brake lever does not rest on the stop bolt. Off-idle backpressure is set by adjusting the air pressure regulator which will in turn increase or decrease off-idle exhaust backpressure. You will need to secure your pressure gauge somewhere that you can see it while you are driving. Using a long extension hose & bringing the gauge into the cab through an open window or clipping it under a windshield wiper works well.

Get the truck up to speed (a downhill grade or a load in the truck is helpful) and activate the exhaust brake. Note the maximum backpressure achieved. You should get peak backpressure at higher RPM (try 3000 RPM in Drive). If you cannot reach the desired backpressure (compare table below) you can begin troubleshooting, the first step is to look for exhaust leaks either from the clamps, exhaust manifolds or feed pipes. Also look for leaks at the clamps located at the back of the turbo and also at the down pipe. If all connections are sealed, you can then use the adjusting regulator to increase the backpressure. Note that small regulator adjustments can have a significant effect on off-idle backpressure.

Turning the regulator **clockwise** will increase pressure.

Turning the regulator **counter clockwise** will decrease pressure.



NOTE: Over the next two weeks, the backpressure at idle may rise due to initial carbon build up on the inside of the brake housing and on the butterfly. The stop bolt may need to be adjusted again to compensate.

Application	Maximum Back Pressure
GM/Chevy 6.5	35 psi
GM/Chevy Duramax	55 psi
Ford Powerstroke	45 psi
Dodge Cummins 1988-98 12V w/o 60lbs Springs	40 psi
Dodge Cummins 1988-98 12V with 60lbs Springs	60 psi
Dodge Cummins 1998 to current	65 psi

*HD Spring part# is 1030060.

CAUTION: Do NOT exceed the maximum back pressure value in the exhaust system. Exceeding this pressure will force the exhaust valves open during the intake stroke which could cause engine damage.

Maintenance

To extend life of the exhaust brake, do not operate the vehicle for extended periods of time without activating the brake. We suggest activating the exhaust brake at least a couple times a day while operating the vehicle to prevent any carbon or rust build up on inner parts of the brake valve assembly.

The hoses, wires, fittings and clamps should be inspected on a regular basis for any deterioration, damage or leaks.

To increase the life of your exhaust brake, we recommend daily operation. By simply switching the brake on and off a couple times a day, it will prevent the butterfly valve from sticking due to carbon build-up.

Following the diagrams in this manual, tracing hoses and wiring, checking continuity through electric components or checking for any lines that are disconnected, should solve any problems that may arise. If you have any problems or need replacement parts, call us at 1-800-887-5030, between 8:30am and 5:00pm Pacific Time.

BD Engine Brake Inc.

Plant Address: 33541 MacLure Rd. Abbotsford, BC, Canada V2S 7W2

U.S. Shipping Address: 88-446 Harrison St, Sumas, WA 98295 U.S. Mailing Address: P.O. Box 231, Sumas, WA 98295

Phone: 604-853-6096 | Fax: 604-853-8749 | Internet: www.bd-power.com

Air Brake Troubleshooting Guide

This guide assumes that your exhaust brake system is using a DFIV and a BD air compressor. If your system uses a microswitch for throttle activation, the operation of the air solenoid and pump are the same as with the DFIV. If you are using existing on-board air, check that system as appropriate.

When I let off the throttle nothing happens.	<u>No</u>	<u>Yes</u>
Is the DFIV powering its "brake" output when the throttle is at idle and brake switch and ignition are both on?	<p>Check if DFIV has good power, ground and throttle signal. Check DFIV adjustment. If these things check out, but the DFIV won't power the "brake" output, the DFIV is likely faulty.</p> <p>Also check power & ground at pump relay and make sure the air solenoid has a good ground.</p>	<p>Check that when air solenoid is powered it will allow air to flow from the #2 port out the #1 port.</p> <p>Check that pump relay is powering pump. If pump has power but does not run, pump is likely faulty. Check for power & ground at pump relay, if these are good but relay does not click or does not power pump, relay is likely faulty.</p>
The brake comes on but there's little or no holdback	<u>No</u>	<u>Yes</u>
<p>See if torque converter is staying locked up during deceleration. If not, the engine RPM will fall to idle when the throttle is released. The brake will be ineffective without the torque converter locked up.</p> <p>Check off idle brake pressure. (See back pressure chart) Are you getting maximum allowable backpressure?</p>	<p>Check for exhaust leaks. A small leak can result in a significant decrease in back pressure. If no leaks are found try adjusting air regulator. Check for air leaks in brake system.</p>	<p>Try down shifting more aggressively. More RPM will give more holdback. Transmission or torque converter could be slipping internally.</p>
Everything seems to work, but the brake valve won't close.	<u>No</u>	<u>Yes</u>
Check that air is reaching brake air cylinder?	Air solenoid or quick release valve are likely stuck, plugged or faulty. Clean or replace as required.	Cylinder or brake valve are seized. Remove the clevis pin on the end of the cylinder rod & see if the valve lever can be moved freely.
The valve lever can be moved freely?	Try dismantling the brake & cleaning the carbon out of it. If this does not work the brake valve will need to be replaced.	The cylinder is stuck and will need to be replaced.
Problem	Solution	
Air compressor runs in short bursts and brake is slow to apply.	There is a restriction in the air system, normally in the regulator or air solenoid. Remove the fittings from the regulator and air solenoid, you will likely find some corrosion or debris caught in them. Clean this out with a pick, small brush, compressed air and WD40 or similar lubricant.	
Air compressor runs continually.	Pump relay is likely stuck on. Check operation of relay & replace as required.	
Brake is slow to release.	Debris or corrosion is restricting the quick release valve or air solenoid. Clean as required. Air solenoid could be too far from brake.	

Thank you and happy motoring.
BD Engine Brake, Inc.

BD Engine Brake Inc.

Plant Address: 33541 MacLure Rd. Abbotsford, BC, Canada V2S 7W2

U.S. Shipping Address: 88-446 Harrison St, Sumas, WA 98295 U.S. Mailing Address: P.O. Box 231, Sumas, WA 98295

Phone: 604-853-6096 | Fax: 604-853-8749 | Internet: www.bd-power.com