



**DOWNLOAD ENHANCED
INSTALL MANUALS AT
*dieselperformance.com***



BD Boost Fooler

Part #	Application
1515931	1998-2000.5 - Dodge Cummins (Tri Plug)
1515932	2001 – Dodge Cummins (Flat Plug)
1515933	2002 – Dodge Cummins (Flag Plug w/adapter)

Please read this manual before starting installation.

NOTE: Unless this product has been identified with a CARB # it is only legal in California for racing vehicles which may never be used upon a highway

Recommend Products

Part	Part#
Adjustable Wastegate (1998 HX35)	1047150
Adjustable Wastegate (1999-02 HX35 only)	1047151
Adjustable Wastegate Control (X Hook – HY35)	1045991

The adjustable wastegate will allow you to create more boost by eliminating boost creep and having better control of the turbocharger boost. Set it, and forget it.

Installation

Locate the boost electrical connection. It is located on the driver's side of the engine near the back by cylinder 5.

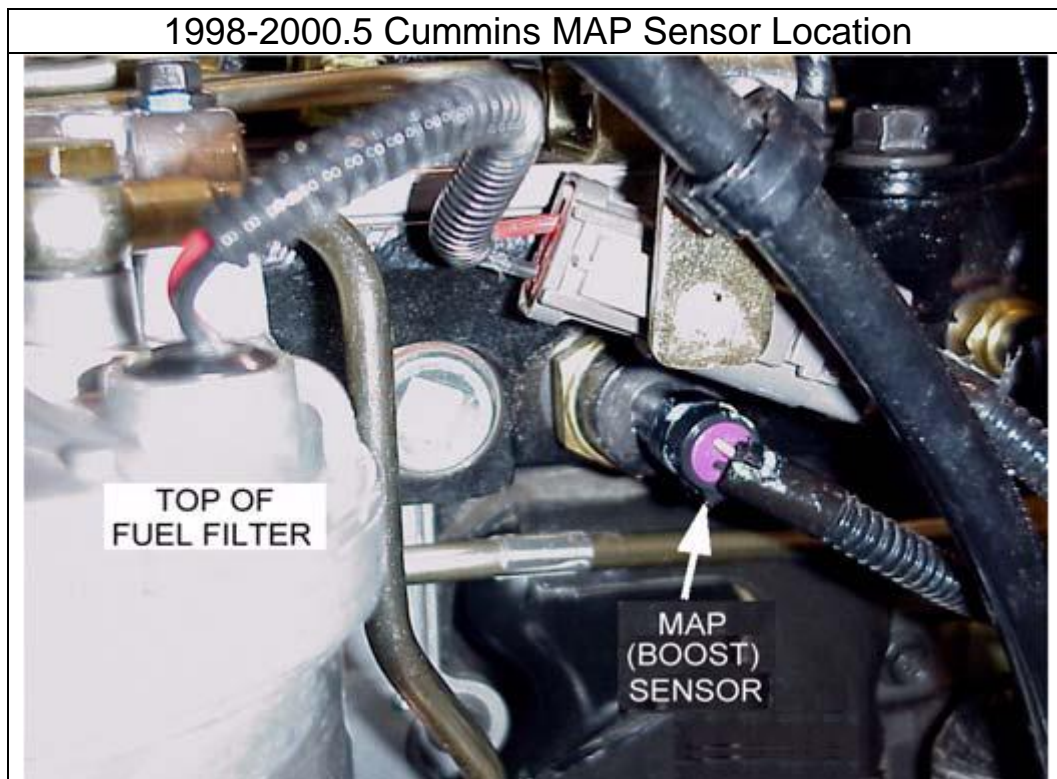

BD Engine Brake Inc.

Plant Address: 33541 MacLure Rd. Abbotsford, BC, Canada V2S 7W2

U.S. Shipping Address: 88-446 Harrison St, Sumas, WA 98295 U.S. Mailing Address: P.O. Box 231, Sumas, WA 98295

Phone: 604-853-6096 | Fax: 604-853-8749 | Internet: www.bd-power.com

2001-2002 Cummins MAP Sensor Location



Note: The 2002 Cummins motor will have white/grey locking plug in same position.

- Disconnect the factory plug from the sensor. Note that on 2002 vehicles you will need to remove the red locking pin, and then press down on the MAP sensor pug to release it from the sensor.
- Insert the BD Boost Fooler between sensor and factory wiring harness.
- Reconnect all connections.

BD Engine Brake Inc.

Plant Address: 33541 MacLure Rd. Abbotsford, BC, Canada V2S 7W2

U.S. Shipping Address: 88-446 Harrison St, Sumas, WA 98295 U.S. Mailing Address: P.O. Box 231, Sumas, WA 98295

Phone: 604-853-6096 | Fax: 604-853-8749 | Internet: www.bd-power.com

**1998-2000.5
#1515931**

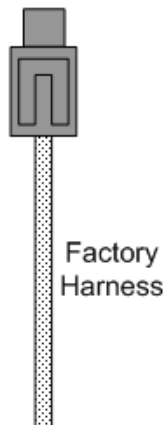
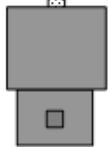
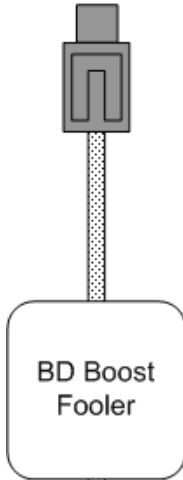
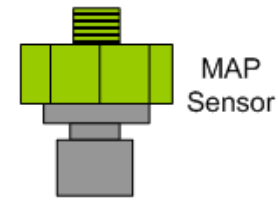

**2001
#1515932**

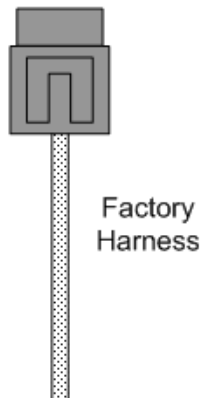
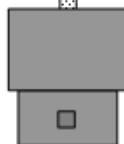
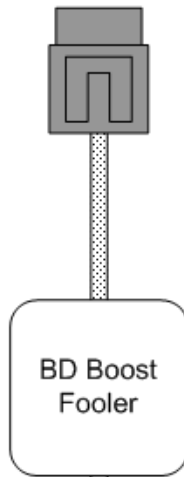
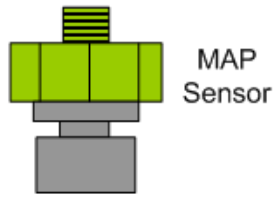

**2002
#15915933**

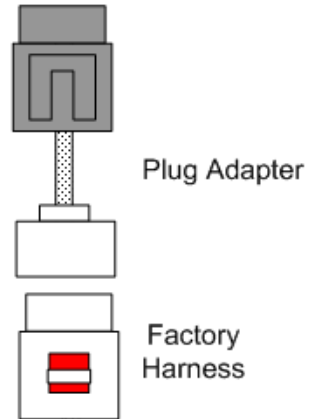
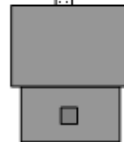
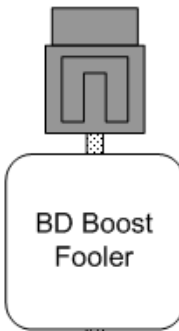
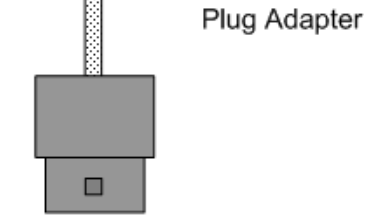
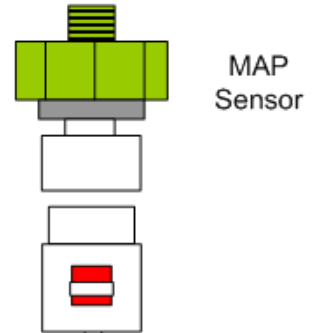

BD Engine Brake Inc.

Plant Address: 33541 MacLure Rd. Abbotsford, BC, Canada V2S 7W2

U.S. Shipping Address: 88-446 Harrison St, Sumas, WA 98295 U.S. Mailing Address: P.O. Box 231, Sumas, WA 98295

Phone: 604-853-6096 | Fax: 604-853-8749 | Internet: www.bd-power.com

Questions?

If you have any technical concerns or questions about this product, please contact our Technical Support hotline at (800) 887-5030, between 8:30am-5:30pm Pacific Standard Time (PST), Monday to Friday. Or, you can post a topic on our informative on-line technical forum, located at <http://www.bd-power.com/>.

BD Engine Brake Inc.

Plant Address: 33541 MacLure Rd. Abbotsford, BC, Canada V2S 7W2

U.S. Shipping Address: 88-446 Harrison St, Sumas, WA 98295 U.S. Mailing Address: P.O. Box 231, Sumas, WA 98295

Phone: 604-853-6096 | Fax: 604-853-8749 | Internet: www.bd-power.com