



Installation Instructions



6" Performance Suspension System 2011-18 GM 4WD 2500HD/3500

Fabtech Motorsports 4331 Eucalyptus Ave. Chino, CA. 91710
Tech Line 909-597-7800 Fax 909-597-7185 Web www.fabtechmotorsports.com



*6" GM 4WD 2500HD/3500 FTS21092,
FTS21093, FTS21094, FTS21097*

	FTS21092	COMPONENT BOX 1		FTS21093	RTS COMPONENT BOX 2
1	FTS20490D	SPINDLE MACHINED DRIVER	1	FT20474BK	FRONT CROSSMEMBER BLACK
1	FTS20490P	SPINDLE MACHINED PASSENGER	1	FT20475BK	REAR CROSSMEMBER BLACK
2	FT20277	OUTER TIE ROD	1	FT20489BK	DIFF SKID PLATE
1	FT20476	DIFF BRACKET DRIVER	1	FT20522	WHEEL SPACER – SPARE TIRE
1	FT20477	DIFF BRACKET PASS	1	FT20074	CARRIER BEARING DROP BRKT
1	FT20486	DIFF DROP REAR	1	FT20494	HARDWARE KIT
2	FT20484	UPPER SHOCK MOUNT	1	FT20495	HARDWARE SUBASSEMBLY
1	FT20487	SWAY BAR EXTENSION DRIV	1	FT20491	REAR BRAKELIKE BRKT DRIV
1	FT20488	SWAY BAR EXTENSION PASS	1	FT20492	REAR BRAKELIKE BRKT CENTER
			1	FT20493	REAR BRAKELIKE BRKT PASS
	FTS21094	COMPONENT BOX 3 – 2500HD	1	FT20511	E-BRAKE BRACKET
2	FT20481	SMALL RTS BUSHING	2	FT20512	ABS BRACKET
2	FT20482	MED RTS BUSHING	2	FT1020	BUSHING
2	FT20483	LG RTS BUSHING	1	FT181	SLEEVE .625 X .509 X 2.365
4	FT752U	UBOLT SQ 3/4-16X15.375X3.100	1	FTREGCARD	REGISTRATION CARD
2	FTBK43	4" BLOCK W/ BUMPSTOP	1	FTAS16	DRIVER WARNING DECAL
1	FT20806	TORSION BAR RELOCATOR DRIV	2	FTAS12	STICKER FT BLUE 10X4 DIE CUT
1	FT20807	TORSION BAR RELOCATOR PASS	2	FT21092I	INSTRUCTIONS
			1	FT20520	FRT BRAKELIKE BRKT DRIV
	FTS21097	COMPONENT BOX 3 – 3500	1	FT20521	FRT BRAKELIKE BRKT PASS
2	FT20481	SMALL RTS BUSHING	1	FT30201	DIFF NUT TAB
2	FT20482	MED RTS BUSHING			
2	FT20483	LG RTS BUSHING			
4	FT753U	UBOLT SQ 3/4-16X17.375X3.100			
2	FTBK43	4" BLOCK W/ BUMPSTOP			
1	FT20806	TORSION BAR RELOCATOR DRIV			
1	FT20807	TORSION BAR RELOCATOR PASS			



TOOL LIST: (NOT INCLUDED)

- FLOOR JACK
- JACK STANDS
- ASSORTED METRIC AND S.A.E SOCKETS, WRENCHES
- DIE GRINDER W/ CUTOFF WHEEL OR SAWZALL
- TORSION BAR REMOVAL TOOL
- TORQUE WRENCH

HARDWARE LIST:

FT20494 BAG1 HARDWARE KIT		
Qty	Part Number	Description
4	25000005252	1/4" LOCK WASHER
4	25000005052	1/4" SAE WASHER
2	50131751081	1/2"-13 x 1-3/4" LONG HEX BOLT
2	50132501081	1/2"-13 x 2-3/4" LONG HEX BOLT
4	25200501081	1/4-20 X 1/2" HEX BOLT
2	50137501081	1/2"-13 x 7-1/2" LONG HEX BOLT
12	50000005081	1/2" SAE WASHER
6	50130004152	1/2"-13 LOCK NUT
4	56121251081	9/16"-12 X 1-1/4" LONG HEX BOLT
8	56000005081	9/16" SAE WASHER
4	56120004182	9/16"-12 LOCK NUT
2	63110003382	5/8"-11 C-LOCK NUT
2	63117501081	5/8"-11 x 7-1/2" LONG HEX BOLT
4	62000005081	5/8" SAE WASHER
2	18251201012	M18-2.5 x 120mm LONG HEX BOLT
2	18251501012	M18-2.5 x 150mm LONG HEX BOLT
2	18250701012	M18-2.5 x 70mm LONG HEX BOLT
8	18000005412	M18 FLAT WASHER
6	18250004182	M18-2.5 LOCK NUT
1	31181001152	5/16"-18 X 1" LONG SELF TAP

FT20494 BAG3 HARDWARE KIT		
8	31181001081	5/16"-18 X 1"LONG HEX BOLT
16	31000005052	5/16" SAE WASHER
8	31180003352	5/16" LOCK NUT
12	56000005081	9/16" SAE WASHER
8	75000005081	3/4" SAE WASHER
8	75160004152	3/4"-16 LOCK NUT
6	FTCLAMP	ADEL CLAMP
6		#8 X 1/2" SELF TAPPING SCREW

FT20494 BAG2 HARDWARE KIT		
2	12175401012	M12-1.75 x 40mm LONG HEX BOLT
2	12000005212	M12 LOCK WASHER
2	12000005412	M12 FLAT WASHER
4	50131251081	1/2"-13 X 1-1/4" LONG HEX BOLT
2	50131501081	1/2"-13 x 1-1/2" LONG HEX BOLT
1	50133001081	1/2"-13 x 3-1/4" LONG HEX BOLT
2	50133501081	1/2"-13 x 3.5" LONG HEX BOLT
1	50134001081	1/2"-13 x 4" LONG HEX BOLT
20	50000005081	1/2" SAE WASHER
10	50130004152	1/2"-13 LOCK NUT
4	62000005081	5/8" SAE WASHER
2	62110003382	5/8"-11 LOCK NUT
2	63111751081	5/8"-11 x 1-3/4" LONG HEX BOLT



INSTALLATION OF THIS SUSPENSION SYSTEM WILL NOT ALLOW THE USE OF THE FACTORY WHEELS

WITH THE INSTALLATION OF THIS KIT YOU MUST RUN A 18x9 OR 20X9 RIM WITH A 5 3/4" BACK SPACING.

VEHICLES THAT WILL RECEIVE OVERSIZED TIRES SHOULD CHECK BALL JOINTS, TIE RODS ENDS AND IDLER ARM EVERY 2500-5000 MILES FOR WEAR AND REPLACE AS NEEDED

THE INSTALLATION OF THIS SUSPENSION SYSTEM SHOULD BE PERFORMED BY TWO PROFESSIONAL MECHANICS.

DO NOT ALTER THE FINISH OF THESE COMPONENTS, EXAMPLE- CHROMING, ZINC PLATING OR PAINTING. CHANGING THE FINISH CAN CAUSE STRUCTURAL FATIGUE OF COMPONENTS.

KIT DOES NOT FIT STANDARD CAB MODEL TRUCKS

SUSPENSION SYSTEM MUST BE INSTALLED WITH FABTECH SHOCK ASBORBERS

CHECK ALL PARTS INCLUDED IN THIS KIT TO THE PARTS LIST ABOVE BEFORE BEGINNING INSTALLATION OF THE KIT. IF ANY PIECES ARE MISSING, CONTACT FABTECH AT 909-597-7800

READ ALL INSTRUCTIONS THOROUGHLY FROM START TO FINISH BEFORE BEGINNING INSTALLATION! IF THESE INSTRUCTIONS ARE NOT PROPERLY FOLLOWED, SEVERE FRAME, DRIVELINE AND / OR SUSPENSION DAMAGE MAY RESULT.

NOTE- PRIOR TO THE INSTALLATION OF THIS SUSPENSION SYSTEM A FRONT END ALIGNMENT MUST BE PERFORMED AND RECORDED. DO NOT INSTALL THIS SYSTEM IF THE VEHICLE ALIGNMENT IS NOT WITHIN FACTORY SPECIFICATIONS. CHECK FOR FRAME AND SUSPENSION DAMAGE PRIOR TO INSTALLTION.

SUSPENSION SYSTEM WILL NOT WORK ON VEHICLES EQUIPPED WITH FACTORY AUTO RIDE SUSPENSION

VERIFY DIFFERENTIAL FLUID IS AT MANUFACTURES RECOMMENDED LEVEL PRIOR TO KIT INSTALLATION. INSTALLATION OF THE KIT WILL RE-POSITION THE DIFFERENTIAL AND THE FILL PLUG HOLE MAY BE IN A DIFFERENT POSITION. (FOR EXAMPLE, IF THE MANUFACTURE RECOMMENDS 3 QUARTS OF FLUID, MAKE SURE THE DIFF HAS 3 QUARTS OF FLUID). CHECK YOUR SPECIFIC MANUAL FOR CORRECT AMOUNT OF FLUID.

USE FT20522 WHEEL SPACER TO INSTALL FACTORY SPARE TIRE.

FRONT SUSPENSION INSTRUCTIONS:

1. Disconnect the negative terminal on the battery. With the vehicle on level ground, set the emergency brake and block the rear tires. Jack up the front end of the truck and support the frame rails with jack stands. **NEVER WORK UNDER AN UNSUPPORTED VEHICLE!** Remove the front tires.
2. Locate the torsion bar adjusting cams and threaded bolts. Measure exposed threads of torsion bar adjusting bolts and record for reinstallation. Mark torsion bars indicating driver and passenger. Using a torsion bar removal tool unload the torsion bars and remove the crossmember and bars. Retain the hardware for reinstallation. NOTE- Do not attempt to unload or remove torsion bars without the proper torsion bar tool. Torsion Bars are under extreme spring load.
3. Remove the sway bar link ends from the sway bar and lower control arm.
4. Remove the stock shocks and discard.
5. Remove front factory differential skid plate and splash shield and discard.
6. Disconnect the tie rod ends from the steering knuckle by striking the knuckle to dislodge the tie rod end. SEE PHOTO BELOW



7. Remove the brake hose bracket from the top of the steering knuckle. Remove the caliper from the rotor and place above the upper control arm during this portion of the installation. . Remove brake rotor from the steering knuckle. Unbolt the wheel speed sensor connection from the hub and control arm. SEE PHOTO BELOW

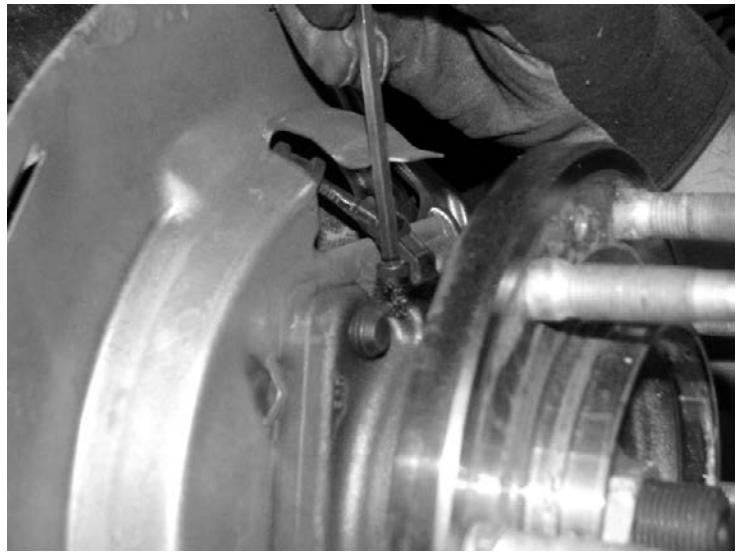

8. Remove axle nut, washer and the 4 hub bolts on backside of knuckle. Remove bearing hub assembly including O ring from knuckle. Retain parts and hardware for reinstallation.
9. Remove the upper and lower ball joint nuts. Disconnect the upper and lower ball joints from the steering knuckle by striking the knuckle with a large hammer next to each ball joint on the knuckle to dislodge the ball joints. Use care not to hit the ball joints when removing. Retain nuts and discard knuckle. SEE PHOTO BELOW

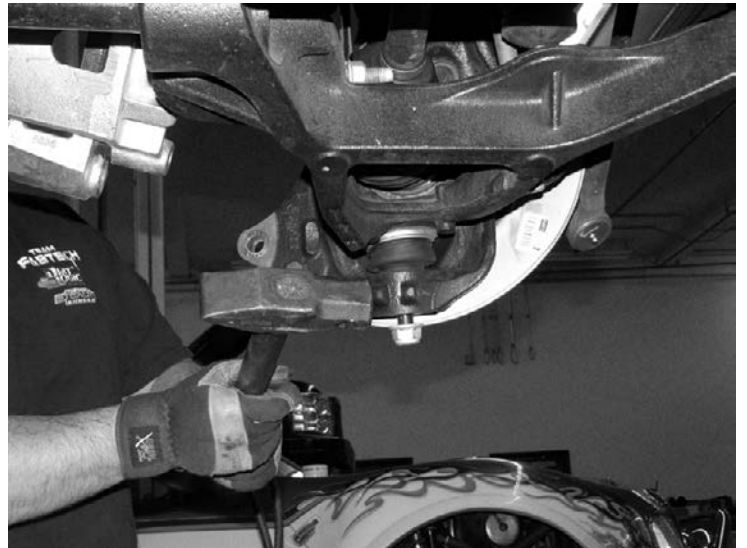

10. Disconnect CV axles from differential housing and remove axle assembly.
11. Remove the lower control arms from the frame and retain the arms and hardware for reinstallation.
12. Disconnect front drive shaft from differential housing and retain bolts and u joint clamps for reinstallation.
13. Disconnect the differential housing electrical connection and vacuum line from differential housing.
14. Remove the stock differential rear crossmember and discard. Remove the differential housing assembly from vehicle. To

ease removal, turn the steering wheel to the left for centerlink clearance.



15. Locate the driver side lower control arm pocket closest to the rear of the vehicle, measure 1-3/8" from the pivot hole of the pocket and mark a vertical cut line around entire pocket. Using a Sawzall or die grinder cut the backside of the pocket and rear differential crossmember off the frame. SEE PHOTO BELOW

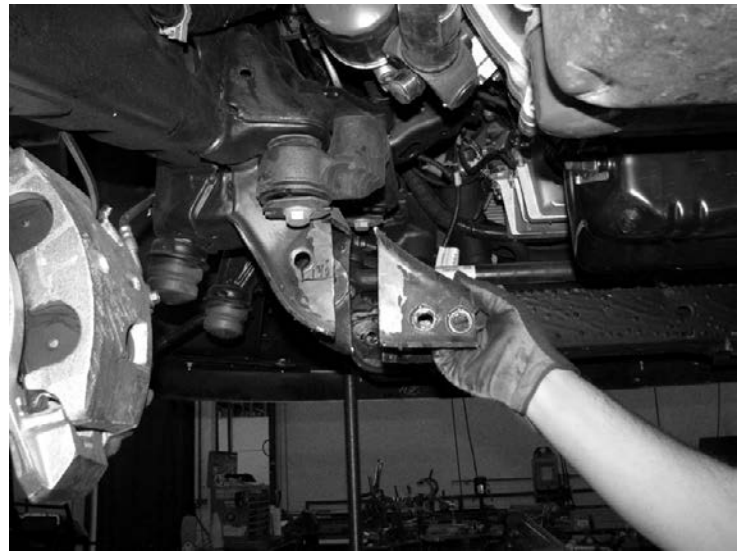

16. Locate the pass. lower control arm pocket and cut out the 3" section over the holes on the front side of the pocket. SEE PHOTO BELOW

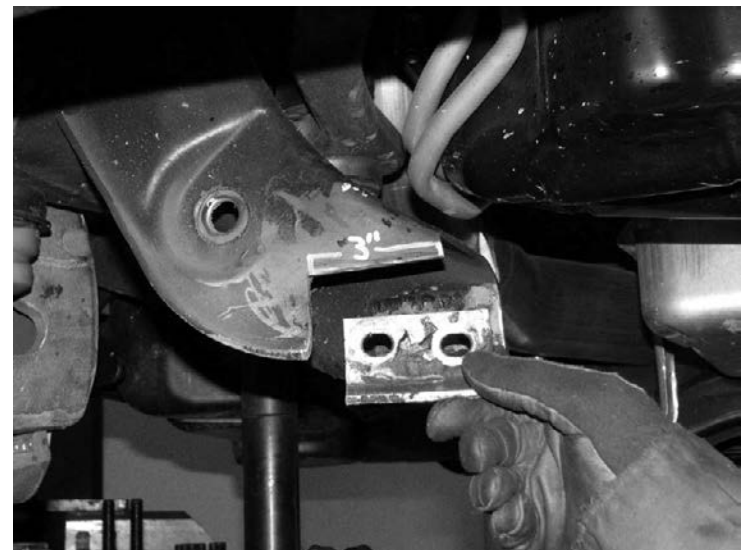

17. Locate the factory differential. Drill out the factory rear Diff mount to 1/2" SEE PHOTO BELOW



18. Locate and install the Fabtech Driver side Diff bracket (FT20476) to the bottom of the factory frame mount. Using two M12-1.75x40mm Bolts, Lock washers and flat washers, torque to 100 ft-lbs. SEE PHOTO BELOW



19. Locate and install the Fabtech Pass side Diff bracket (FT20477) to the bottom of the factory frame mount using the factory hardware. SEE PHOTO BELOW



20. Locate the stock differential and reinstall with the 2ea 1/2"-13 x 3-1/2" bolts, washers and lock nuts on the driver side and the 2-1/2"-13 x 1-1/2" bolts, washers and lock nuts on the pass side. Torque all the bolts to 127 ft-lbs. SEE PHOTOS BELOW





21. Check this area of the frame after installing the Diff. You may need to add a small amount of clearance for the CV. SEE PHOTO BELOW

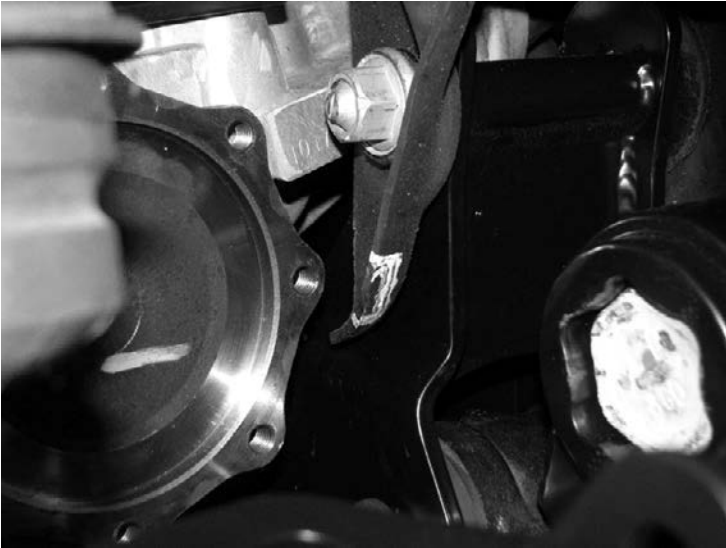

22. Reinstall the factory front drive shaft and torque to 29 ft-lbs. SEE PHOTO BELOW

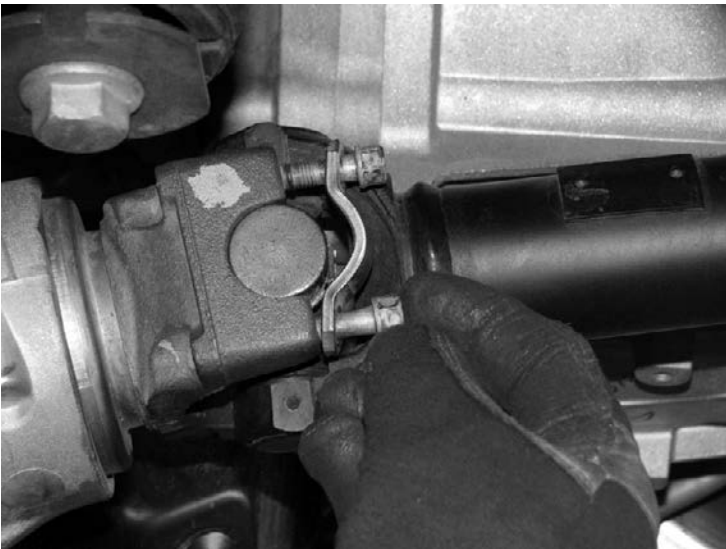

23. Locate the Rear diff bracket (FT20486). Assemble the bushings (FT1020) and the sleeve (FT181) in the barrel of the bracket. SEE PHOTO BELOW



24. Install the Rear Diff bracket (FT20486) into the mount on the rear crossmember (FT20475BK). Use the 1/2"-13x4" bolt and the FT30201 nut tab to secure the bracket to the cross member. Leave loose. SEE PHOTO BELOW



25. Install Fabtech rear crossmember (FT20475BK) using the factory control arm hardware. Leave the hardware loose at this time. SEE PHOTO BELOW



26. Attach the rear Diff mount (FT20486) to the last open mounting tab on the Factory Diff using a 1/2"-13 x 3" bolt, washers, and lock nut. Torque all the hardware to 127 ft-lbs. SEE PHOTO BELOW

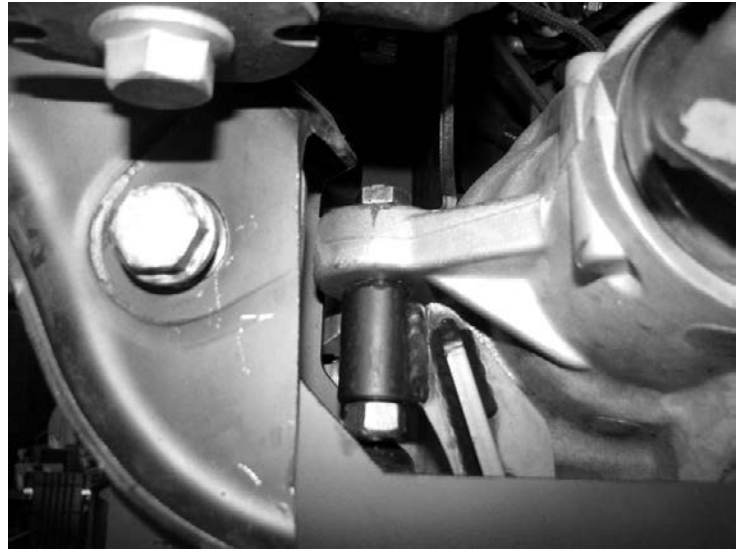
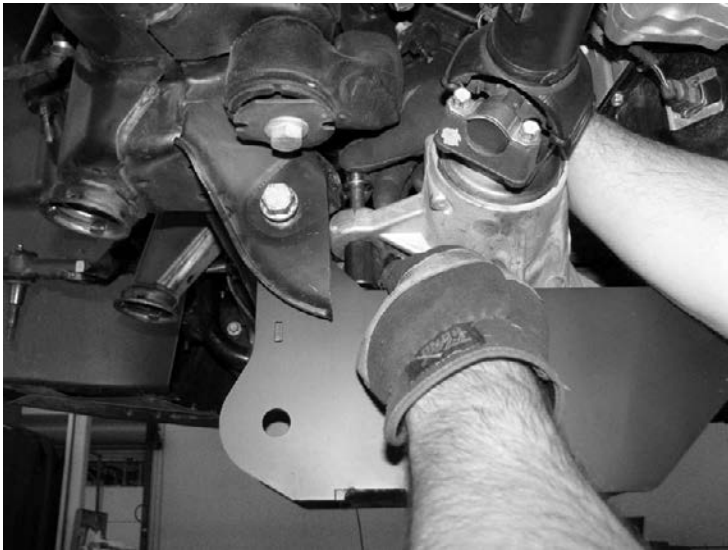

27. Locate the front crossmember (FT20474BK) and install into the factory pockets using the factory hardware. Leave the hardware loose at this time. SEE PHOTO BELOW



28. Locate the factory lower control arms and remove the lower shock mount bushing using a ball joint press tool. SEE PHOTO BELOW



29. Locate the large aluminum RTS bushing (FT20483) and install it into the front side of the torsion bar socket in the lower control arm. SEE PHOTO BELOW

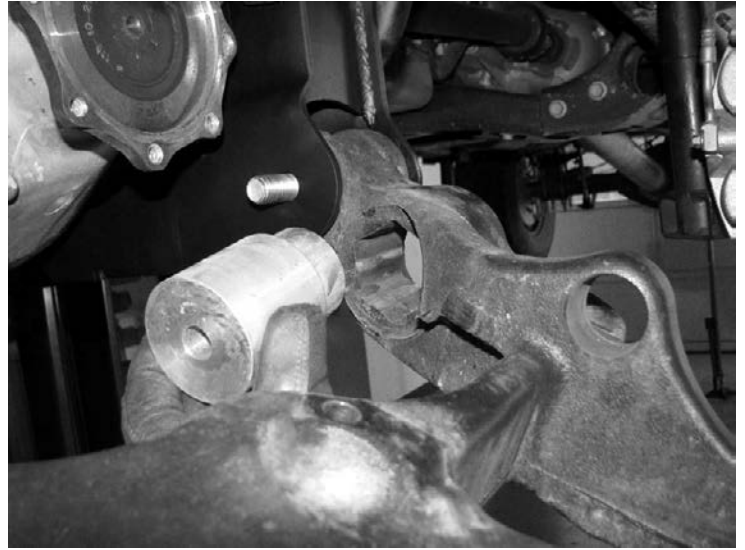

REFERANCE THE DIAGRAM BELOW FOR STEPS 29 - 33

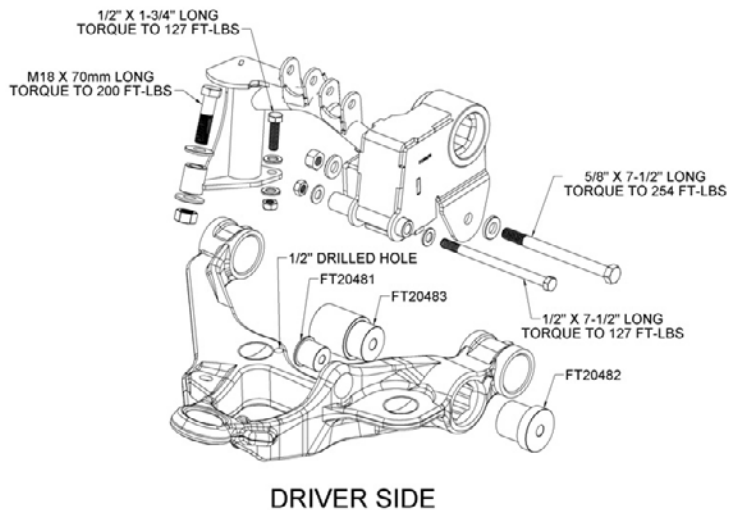

30. Locate the medium aluminum RTS bushing (FT20482) and install it into the back side of the torsion bar socket in the lower control arm. SEE PHOTO BELOW



31. Locate the small aluminum RTS bushing (FT20481) and the lower control arm. Install the bushing into the front side of the shock mount where the OEM bushing was removed from in step 28. SEE PHOTO BELOW



32. Locate the Torsion Bar mount for the Driver side lower control arm (FT20806). Temporarily install the torsion bar relocator to the arm by installing front and rear bolts. This will be done to mark a hole to be drilled that is needed to attach the bracket. Mark the hole using a transfer punch. SEE PHOTO BELOW



33. Remove the torsion bar bracket and drill a 1/2" hole. SEE PHOTO BELOW



34. Locate the factory lower control arms and install the Driver and Passenger arms into the pockets on the Fabtech front and rear crossmembers. The front crossmember will require M18-2.5x120mm bolts, washers and lock nuts. The rear crossmember will require M18-2.5x150mm bolts, washers and lock nuts. Leave loose at this time. SEE PHOTO BELOW

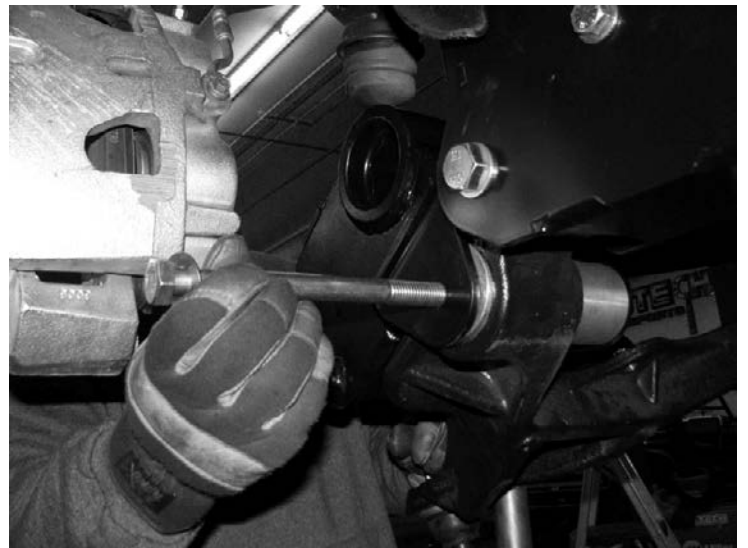
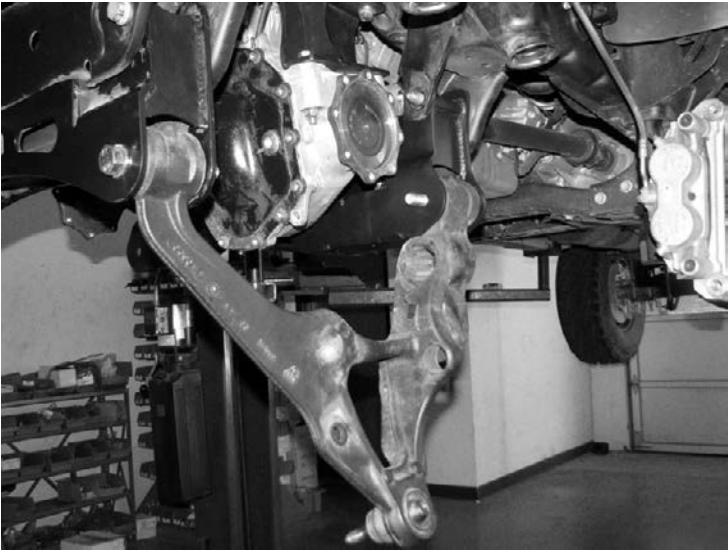
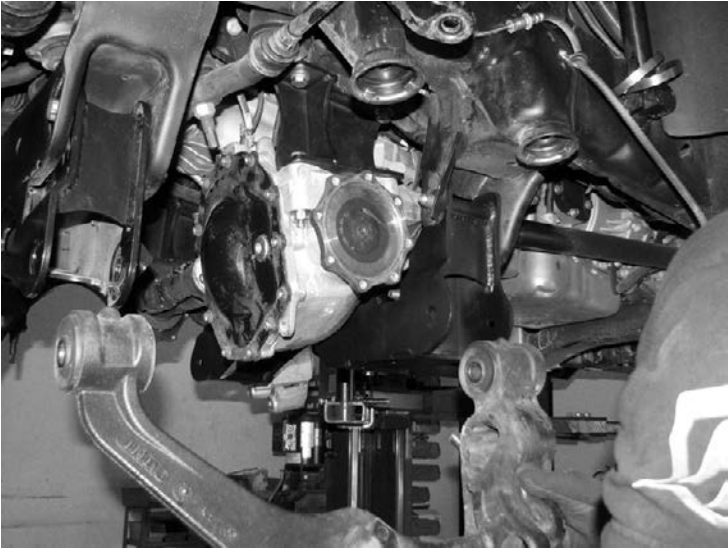

35. Locate the Torsion Bar mount for the Driver side lower control arm (FT20806). Install the torsion bar relocater to the arm using the supplied hardware 1/2"-13 x 7-1/2", 1/2"-13 x 1-3/4", 5/8"-11 x 7-1/2", M18-2.5x70mm., washers and lock nuts. Reference the diagram above step 29 for all the torque specifications for the torsion bar bracket. SEE PHOTO BELOW

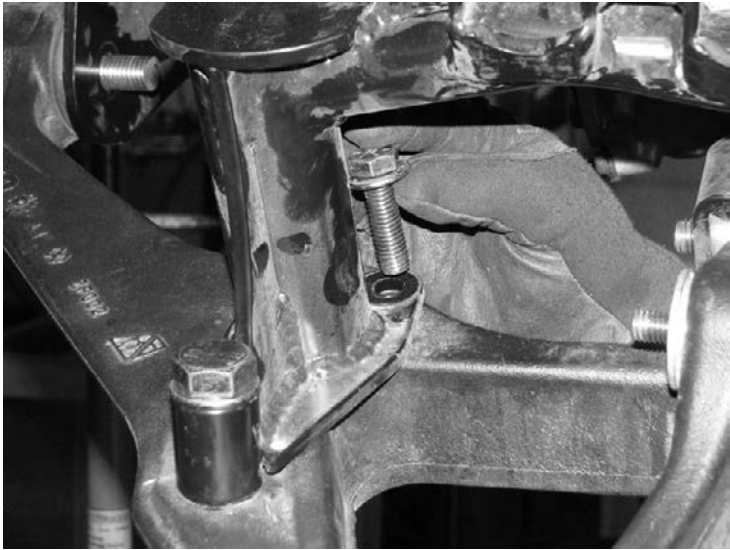

36. Remove 1/2" of thread from the tie rod using a die grinder. SEE PHOTO BELOW



37. Install the upper shock mount (FT20484) into the factory upper shock tower using the using two 9/16"-12 x 1-1/4", washers and lock nuts. Torque to 184 ft-lbs. NOTE: Using a grinder, open up the hole on the upper factory shock mount to prevent contact with the new Fabtech upper shock washer. SEE PHOTO BELOW



38. Install the front shock (FT7338) with the stem in the upper mount. SEE PHOTOS BELOW

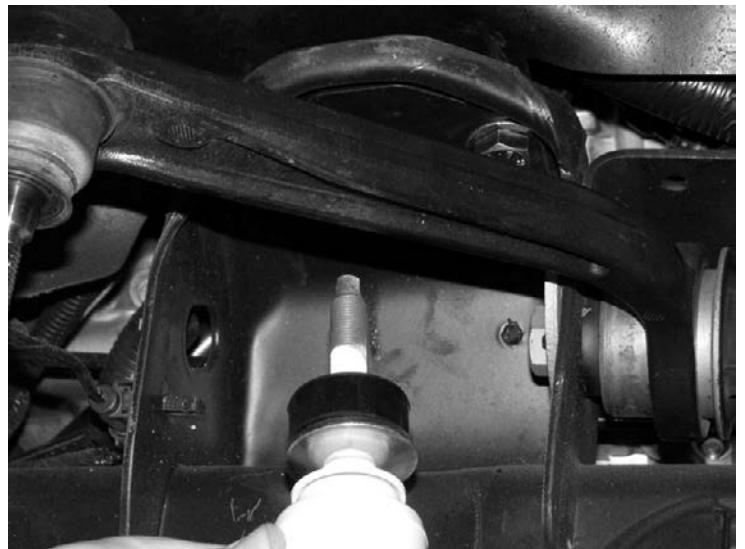

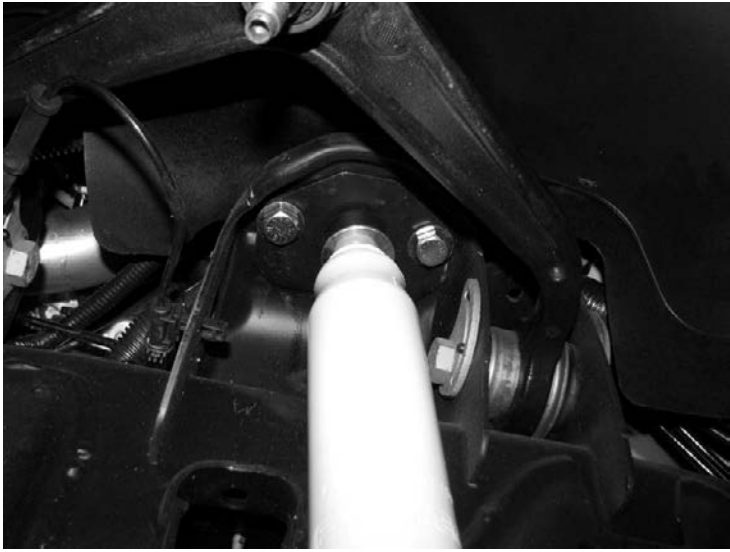

39. Install the lower mount of the shock into the rear shock mount on the torsion bar bracket that is mounted to the lower control arm. Use a 1/2"-13 x 2-3/4" bolt, washers and lock nut. Torque to 127 ft-lbs. SEE PHOTO BELOW

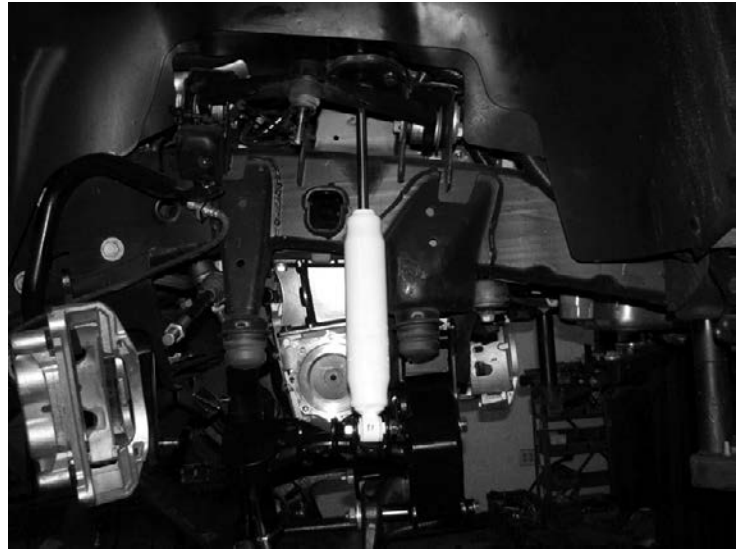
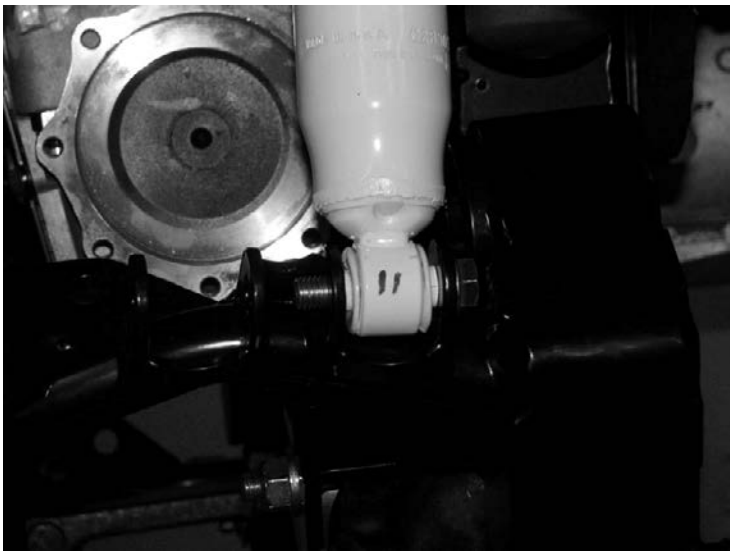

40. Locate the factory crossmember the torsion bar runs through. This cross member will need a small amount of clearance added to it. At the intersection of the frame and the crossmember, grind a 2" Radius 1/4" deep. SEE PHOTO BELOW



41. Locate and install the factory torsion bar through the hex in the torsion bar mount. Thread the torsion bar all the way back in the

factory torsion bar key. **DO NOT LOAD KEY AT THIS TIME.** SEE PHOTOS BELOW



42. Locate the Fabtech spindle (FTS20490D) and install onto the upper and lower ball joints. Torque the upper ball joint 65 ft-lbs. and lower ball joints to 100 ft-lbs. SEE PHOTO BELOW.

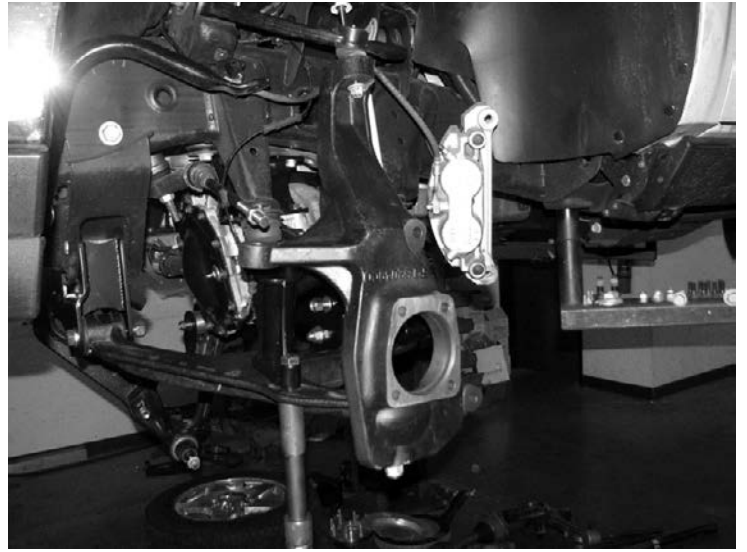

43. Locate the factory CV shaft and reinstall. Push the axle bell through the opening for the hub on the Fabtech spindle. This will locate under the shock mount on the torsion bar bracket. Bolt the flange on the CV shaft to the mating flange on the diff. Torque to 58 ft-lbs. SEE PHOTO BELOW

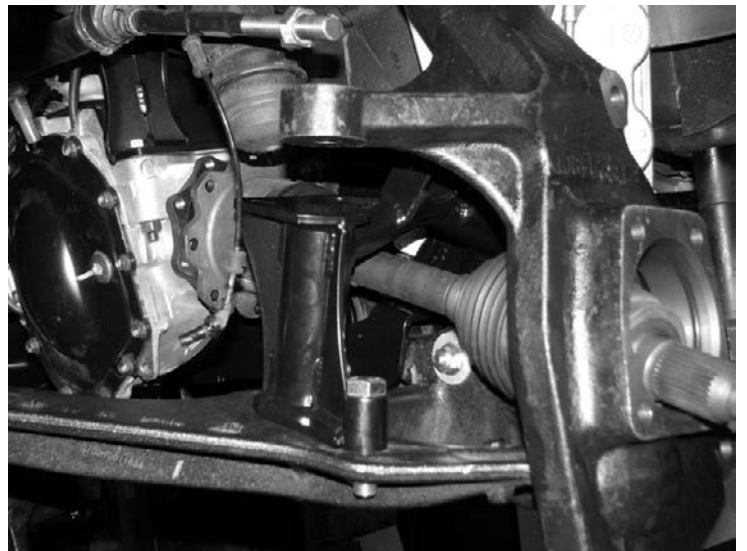



44. Locate the o-ring, dust shield and hub. Install into the Fabtech spindle. Torque the factory hub bolts 184 ft-lbs. Install the axle nut and torque to 165 ft-lbs. Replace axle nut cover. SEE PHOTOS BELOW

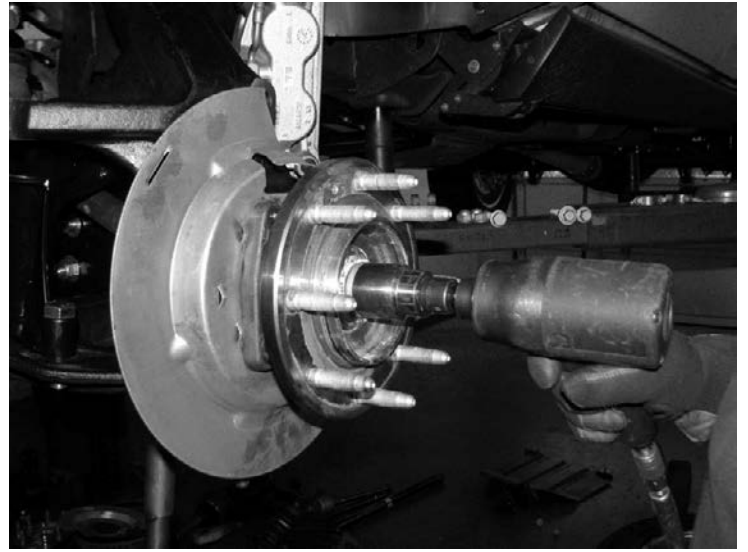

45. Install the rotor and the small bolt retaining the rotor and torque 12 ft-lbs. Install the caliper and torque to 220 ft-lbs. SEE PHOTO BELOW



46. Locate the Fabtech Driver side sway bar extension bracket (FT20487), and mount to the factory sway bar with tab on the bottom side of the bracket indexing the sway bar. Use a 5/8-11x 1 3/4 bolt, washers and lock nut to attach the sway bar bracket to the factory sway bar. Torque to 254 ft-lbs. Locate the Factory sway bar link and mount through the hole in the Fabtech sway extension connecting it to the Fabtech torsion bar mount located on the lower control arm. Torque to 37 ft-lbs. SEE PHOTOS BELOW



47. Remove the factory brake line bracket by either carefully cutting it off or bending it apart. Next, Install the front brake line extension bracket (FT20520) with the factory hardware and supplied 5/16" hardware. Clamp the ABS and brake line to the spindle using the supplied adel clamps and 1/4" bolts. SEE PHOTOS BELOW

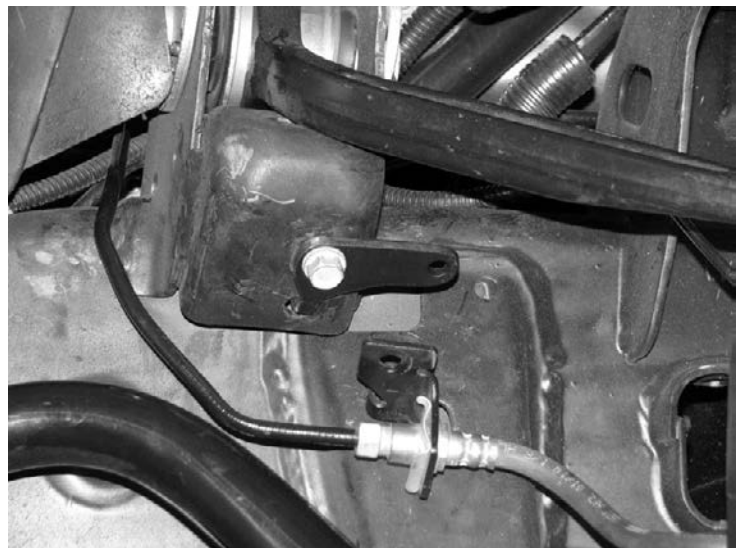

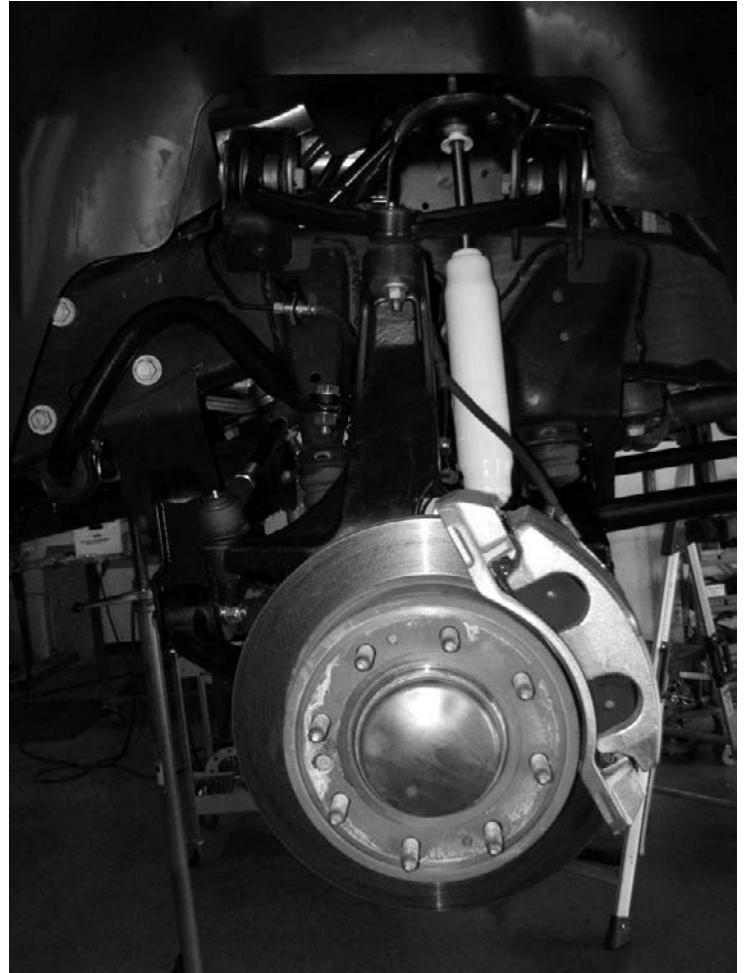
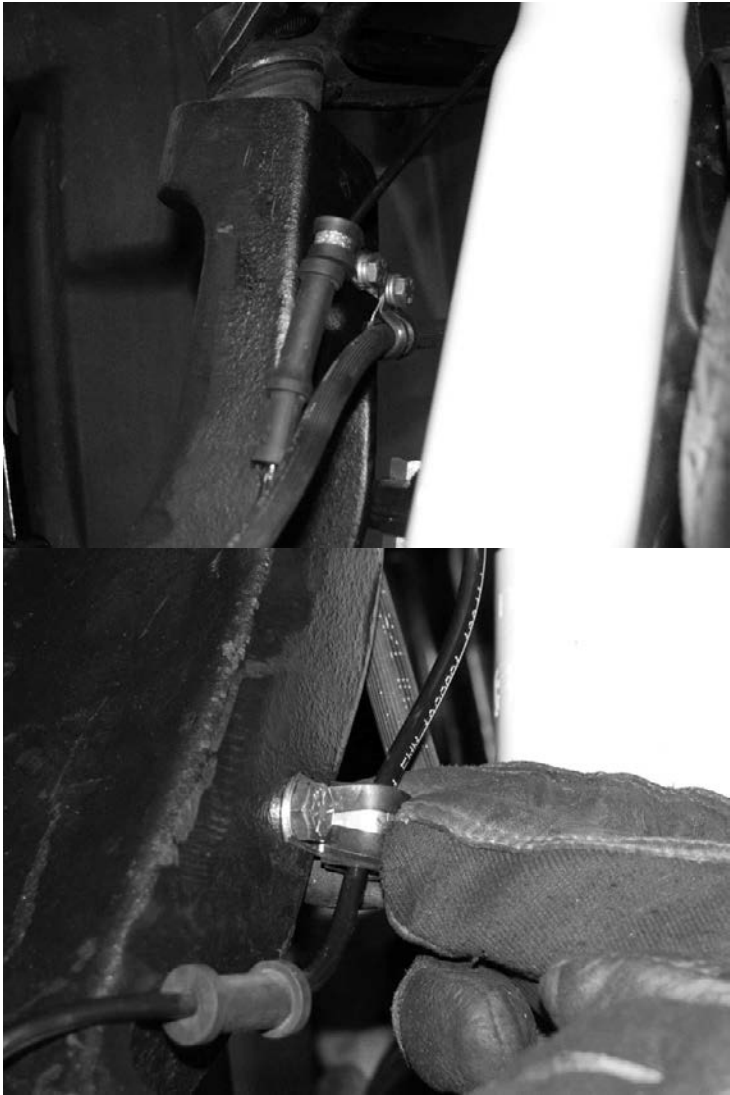

Install the Fabtech outer tie rod end (FT20277) onto the factory tie rod. SEE PHOTO BELOW



48. Insert the tie rod into the spindle and torque to 60 ft-lbs.
49. Repeat steps 28 – 48 on the passenger side of the vehicle.
50. Locate the Fabtech differential skid plate (FT20489BK). Mount the skid plate to the front crossmember using 2 1/2-13x1-1/4 bolts, washers and lock nuts. Mount the skid plate to the rear

crossmember using 2 ½-13x1-1/4 bolts, washers and lock washers. Torque to 127 ft-lbs. SEE PHOTO BELOW



51. At this time locate the following bolts and torque to the specs provided below.
 - a. Front crossmember bolts – 200 ft-lbs
 - b. Rear crossmember bolts – 200 ft-lbs
 - c. Lower control arm pivot bolts – 200 ft-lbs
 - d. Rear differential mount 127 ft-lbs

52. Install the torsion bar adjuster screw assembly, and set to premeasured factory specs.

53. Trim factory front shield and reinstall using factory hardware. SEE PHOTO BELOW



REAR SUSPENSION INSTRUCTIONS

54. Jack up the rear end of the vehicle and support the frame rails with jack stands. Supporting the rear differential, remove and discard the rear shocks and u-bolts. Lower axle down slowly. Use care not to over extend the brake hose.

55. Locate the following rear brake hose and wheel speed sensor extension brackets (FT20512, FT20491, FT20492 and FT20493). Install between differential housing and brake hose using 5/16” bolts, nuts, washers and stock hardware. Check brake hoses for proper extended length and routing as to allow full rear travel without over extending hose. SEE PHOTOS BELOW

FT20512

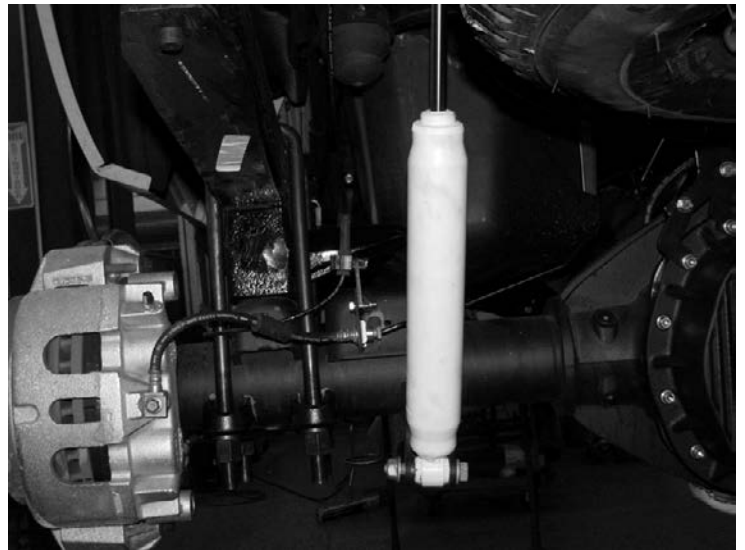
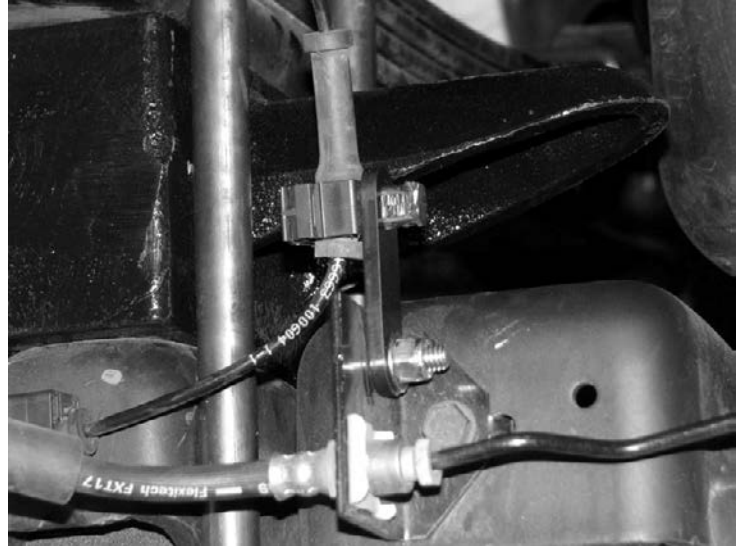

FT20491



FT20492



FT20493

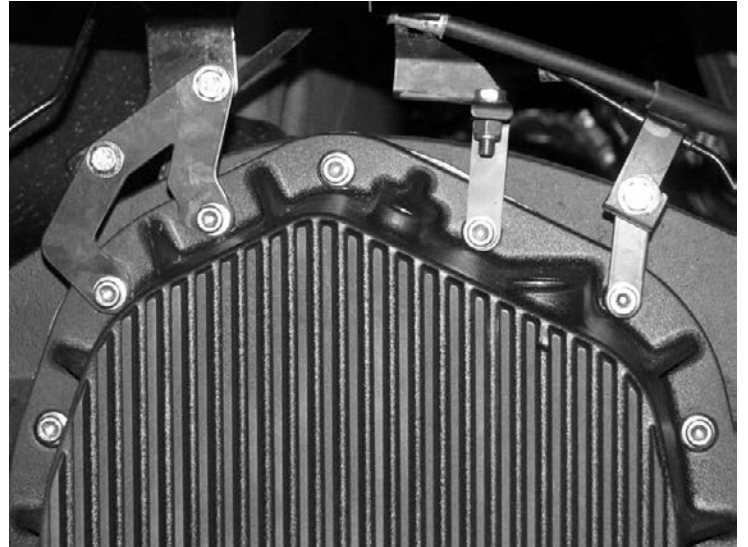
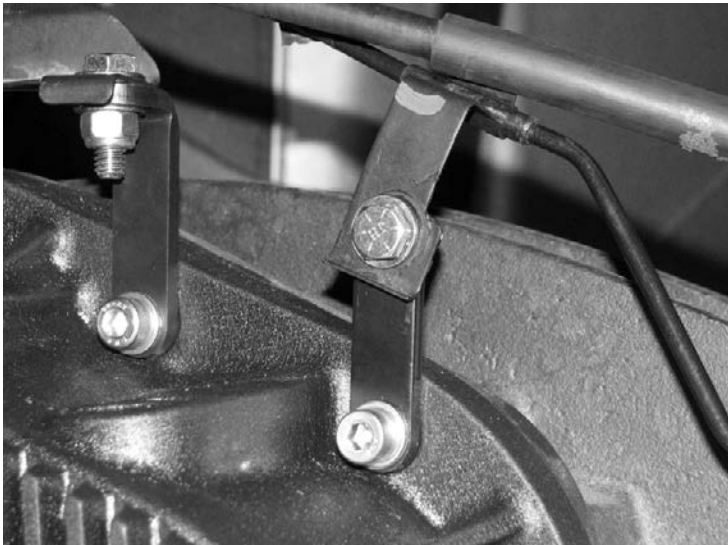

Install the E brake drop bracket (FT20511) on the driver side rear of the vehicle. Drill and install the 5/16" sheet metal bolt to lock the part in place. Use a 5/16" bolt, nut and washers to attach the brake cable to the Fabtech bracket. SEE PHOTOS BELOW



56. Locate and install the rear lift blocks with the provided short center pin on the bottom of the block, to the axle. The integrated bump stop should face to the inside of the vehicle. Using the provided U bolts, nuts and washers align axle, lift blocks, and springs and torque to U Bolts to 317 ft-lbs. SEE PHOTO BELOW.

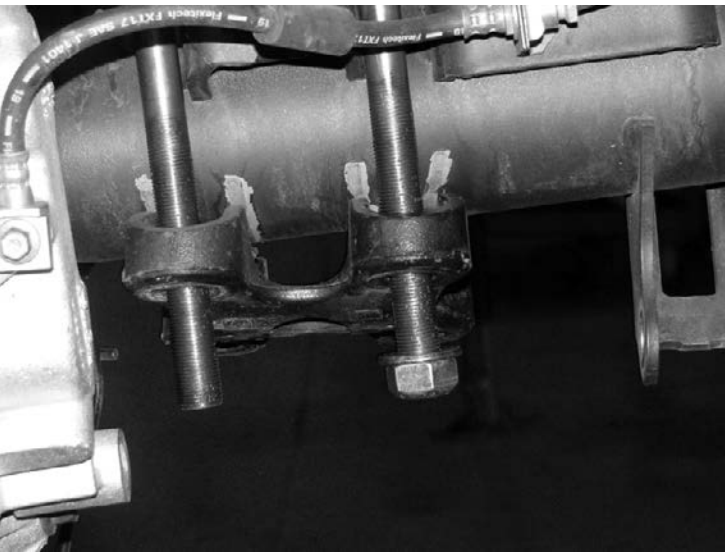

57. Install Fabtech shock part number FTS7333 (not included) with the factory hardware and one 9/16" washer per side on both upper and lower mounts. Torque bolts to 65 ft-lbs. SEE PHOTO BELOW



58. For vehicles with a two-piece rear driveshaft, locate and install FT20074 spacer between the carrier bearing and frame. Push out stock mounting bolts and use 3/8" x 2" bolts, nuts and washers. Torque to 30 ft-lbs. SEE PHOTO BELOW



59. Recheck all bolts for proper torque. Recheck brake hoses and lines for proper clearances.
60. Check the fluid in the front differential and fill if need with factory specification differential oil.
61. Install tires and wheels and torque lug nuts to wheel manufacturer's specifications. Turn front tires left to right and check for appropriate tire clearance. Note - Some oversized tires may require trimming of the front bumper & valance.
62. Check front end alignment and set to factory specifications. Readjust headlights

INSTALLATION OF THIS SUSPENSION SYSTEM WILL NOT ALLOW THE USE OF THE FACTORY WHEELS. SPARE TIRE CAN BE USED WITH FT20522 WHEEL SPACER.

RETORQUE ALL NUTS, BOLTS AND LUGS AFTER 50 MILES AND PERIODICALLY THEREAFTER.

For technical assistance call: 909-597-7800

Product Warranty and Warnings-

Fabtech provides a Limited Lifetime Warranty to the original retail purchaser who owns the vehicle, on which the product was originally installed, for defects in workmanship and materials.

The Limited Lifetime Warranty excludes the following Fabtech items; bushings, bump stops, ball joints, tie rod ends, limiting straps, cross shafts, heim joints. These parts are subject to wear and are not considered defective when worn. They are warranted for 60 days from the date of purchase for defects in workmanship.

Take apart shocks are considered a serviceable shock with a one year warranty on leakage only. Service seal kits are available separately for future maintenance. All other shocks are covered under our Limited Lifetime Warranty.

Fabtech does not warrant any product for finish, alterations, modifications and/or installation contrary to Fabtech's instructions. Alterations to the finish of the parts including but not limited to painting, powdercoating, plating and/or welding will void all warranties. Some finish damage may occur to parts during shipping which is considered normal and is not covered under warranty.

Fabtech products are not designed nor intended to be installed on vehicles used in race applications or for racing purposes or for similar activities. (A "RACE" is defined as any contest between two or more vehicles, or any contest of one or more vehicle against the clock, whether or not such contest is for a prize). This warranty does not include coverage for police or taxi vehicles, race vehicles, or vehicles used for government or commercial purposes. Also excluded from this warranty are sales outside of the United States of America.

Installation of most suspension products will raise the center of gravity of the vehicle and will cause the vehicle to handle differently than stock. It may increase the vehicle's susceptibility to a rollover, on road and off road, at all speeds. Extreme care should be taken to operate the vehicle safely at all times to prevent rollover or loss of control resulting in serious injury or death. Fabtech front end Desert Guards may impair the deployment or operation of vehicles equipped with supplemental restraining systems/air bag systems and should not be installed if the vehicle is equipped as so.

Fabtech makes every effort to ensure suspension product compatibility with all vehicles listed in the catalog, but due to unknown auto manufacturers production changes and/or inconsistencies by the auto manufacturer, Fabtech cannot be responsible for 100% compatibility, including the fitment of tire and wheel sizes listed. The Tire and Wheel sizes listed in Fabtech's catalog are only a guideline for street driving with noted fender trimming. Fabtech is not responsible for damages to the vehicle's body or tires.

Fabtech's obligation under this warranty is limited to the repair or replacement, at Fabtech option, of the defective product only. All costs of removal, installation or re-installation, freight charges, incidental or consequential damages are expressly excluded from this warranty. Fabtech is not responsible for damages and/or warranty of other vehicle parts related or non related to the installed Fabtech product. This warranty is expressly in lieu of all other warranties expressed or implied. This warranty shall not apply to any product that has been subject to accident, negligence, alteration, abuse or misuse as determined by Fabtech.

Fabtech suspension components must be installed as a complete system including shocks as shown in our current catalog. All warranties will become void if Fabtech parts are combined and/or substituted with other aftermarket suspension products. Combination and/or substitution of other aftermarket suspension parts may cause premature wear and/or product failure resulting in an accident causing injury or death. Fabtech does not warrant products not manufactured by Fabtech.

Installation of Fabtech product may void the vehicles factory warranty; it is the consumer's responsibility to check with their local vehicle's dealer for warranty disposition before the installation of the product.

It is the responsibility of the distributor and/or the retailer to review all warranties and warnings of Fabtech products with the consumer prior to purchase.

Fabtech reserves the right to supercede, discontinue, change the design, finish, part number and, or application of parts when deemed necessary without written notice. Fabtech is not responsible for misprints or typographical errors within the catalog or price sheet.

Instruction Sheet Part #-FT21092i

4/6/16 AK