



**DIABLOSPORT®**  
GASOLINE AND DIESEL TUNING SYSTEMS  
*Product Manual*

SALES: 1-800-396-6614  
TECH: 1-800-531-5484



**EXTREME**  
**POWER**  
**PUCK**



# THANK YOU

Thank you for choosing DiabloSport, the World's Greatest Automotive Performance Company. We hope that you enjoy your new Extreme PowerPuck. Although we would love to tell you that you are the first one to touch this individual Extreme PowerPuck that is not the case. The Extreme PowerPuck you are now holding has gone through many different hands to individually inspect each component to ensure it meets DiabloSport's highest standards. We take pride in each and every product we produce and hope you take the same pride in the product you are now holding in your hands. Welcome to the DiabloSport family.

Happy Driving,  
The DiabloSport Team

**End User  
License  
Agreement,  
Warranty  
and  
Disclaimer**

**1**

[www.DIABLOSPORT.COM](http://www.DIABLOSPORT.COM)

---

## End User License Agreement, Warranty and Disclaimer

---

*THIS END USER LICENSE AGREEMENT (the "Agreement") is an agreement between you, as the purchaser (the "Purchaser") of either the Diablo Module (the "Module") or the hand-held computer unit (the "Unit"), and as the manufacturer of the Product DiabloSport ("DiabloSport"). The Product and the Unit shall be referred to collectively herein as the "product" and DiabloSport Inc. shall be referred to herein as "DiabloSport".*

*1. Acknowledgment And Acceptance Of Agreement. If you do not agree to the terms and conditions of this Agreement, do not use the Product. Instead, promptly contact the distributor from which you purchased the Product in writing, requesting a refund of the purchase price. Any use of the Product by you will constitute your agreement to the terms and conditions contained herein.*

*2. Grant Of License. The parties hereto acknowledge that DiabloSport is granting a non-transferable restricted license to Purchaser to use the Product for the sole purpose of installation in Purchaser's vehicle. DiabloSport shall retain all title, ownership rights and intellectual property rights in and to the Product. Purchaser agrees that Purchaser shall not, directly or indirectly, modify, translate, reverse engineer, decompile, disassemble, or create derivative works based on the Product. Purchaser further agrees not to permit any third parties to modify, translate, reverse engineer, decompile, disassemble, or create derivative works based on the Product.*

---

## End User License Agreement, Warranty and Disclaimer

---

*3. Disclaimer. The Product is being sold with no warranties of any kind, express or implied. The Product is not endorsed by the manufacturer of your vehicle and there is no affiliation between DiabloSport and the manufacturer of your vehicle. Installation of the Product in your vehicle or use of the Product with your vehicle may limit or void your rights under any warranty provided by the manufacturer of your vehicle, and DiabloSport assumes no responsibility in such event. Any warranty not provided herein, and any remedy which, but for this provision, might arise by implication or operation of law, is hereby excluded and disclaimed. The implied warranties of merchantability and of fitness for any particular purpose herein are expressly disclaimed.*

*4. No Liability For Damages, Injuries Or Incidental, Special Or Consequential Damages. Under no circumstances shall DiabloSport, or any other party related to DiabloSport, be liable to Purchaser or any other person for any damage to Purchaser's vehicle, loss of use of Purchaser's vehicle, or for personal injuries suffered by any person, or for any incidental, special or consequential damages, whether arising out of negligence, breach of warranty, breach of contract, or otherwise. DiabloSport's liability for any damages, loss and/or claims associated with the Product shall be limited to the price of the Product paid by purchaser. Purchaser hereby releases DiabloSport from all liability, claims and damages associated with the Products, with the sole exception of DiabloSport's liability for the refund of the purchase price of the Product to Purchaser in the event that a court of competent jurisdiction determines the Purchaser suffered damages directly resulting from the malfunction of the Product.*

---

## End User License Agreement, Warranty and Disclaimer

---

5. *Warranty. Notwithstanding the provisions of the End User License Agreement, DiabloSport warrants the Product to be free from all defects in material and workmanship for 2 years from the date of original purchase. This limited warranty applies only to the original Purchaser of the Product. This limited warranty does not cover damage caused by modification, alteration, repair or service of the Product by anyone other than DiabloSport, physical abuse, misuse, use in a manner contrary to the instructions, which accompany the Product, or any damage caused by acts of God. Contacting your Distributor or Dealer may make claims for repair service or replacement of the Product pursuant to this limited warranty. The Chip will either be repaired or replaced, at the option of DiabloSport, at no cost to Purchaser, if the defective Product is covered by this limited warranty. DiabloSport's liability pursuant to this limited warranty and for any damages, loss and/or claims associated with the Product shall be limited to the price of the Product paid by Purchaser, or, at DiabloSport's option, repair or replacement of the Product.*

### Warranty Information

---

- a. DiabloSport offers a 30 day satisfaction guarantee on all products.*
- b. DiabloSport products carry a 2 year warranty against defects in materials or workmanship.*
  - i. DiabloSports liability under this warranty shall be limited to the correction or replacement of any defective part or product in question which DiabloSport determines to be necessary.*
  - ii. Warranty freight charges are the responsibility of the dealer distributor and/or customer.*
  - iii. This warranty is to the original purchaser and is non transferable.*
  - iv. This warranty is void unless proof of purchase is submitted.*

---

## End User License Agreement, Warranty and Disclaimer

---

*Product must be purchased at an DiabloSport Authorized Dealer in order to qualify for warranty.*

*v. Removal of serial numbers and/or alteration of product or packaging will also void all warranties.*

*c. DiabloSport shall not be held responsible for direct or indirect failures due to our product.*

*d. DiabloSport shall not credit or repair any units that are not properly restored to the original backup upon time of return or may be VIN locked.*

*i. VIN locked units, or improperly restored units, will be returned to customer.*

*ii. It is the customers responsibility to check any and all DiabloSport product to make sure the original backups have been restored to vehicles before the product shall be returned.*

*e. Technical Support*

*i. DiabloSport customers should maintain adequate knowledge of the DiabloSport product line to be able to properly sell, and to service the needs of their customers.*

*ii. DiabloSport will provide technical assistance and advice directly to the dealer/distributor to enable them to answer and field technical questions.*

*iii. It is the responsibility of the dealer distributor to handle their own technical issues with customers, and not to direct them to DiabloSport.*

*f. Product updates*

*i. DiabloSport shall inform all customers of the latest product as soon as they are available. DiabloSport will inform customers on our website at [www.diablosport.com](http://www.diablosport.com).*

*ii. DiabloSport cannot be held accountable for any or all damages caused by using outdated product.*

*iii. Products that need updates will be handled in the following fashion:*

*1. DiabloSport will charge a labor and handling fee for products that are internet updateable or remotely updateable.*

---

## End User License Agreement, Warranty and Disclaimer

---

2. DiabloSport will not charge a fee for products that are not internet updateable or remotely updateable. Shipping charges may apply.

iv. All products returned for update purposes must have a corresponding DiabloSport RMA number for processing.

g. Returns and RMA/RGA policies and procedures

i. DiabloSport will not warranty, credit, or exchange any product returned without a valid RMA number.

1. All RMA numbers are issued by DiabloSport RMA department.

2. Defective units shall be repaired and returned in like kind.

All units that must be re-furbished to like new condition are subject to labor and parts charges to be determined by DiabloSport.

ii. Customers are subject to a 20% restocking fee for all product returned for credit.

iii. All units on RMA MUST have conditions for which they were returned clearly labeled on the box, or given to a DiabloSport RMA representative at the time the RMA is issued.

6. State Law. Some states do not allow limitations of implied warranties, or the exclusion or limitation of incidental, special or consequential damages, so the above limitations may not apply to you. In such states, liability shall be limited to the greatest extent permitted by applicable law.

7. Governing Law & Venue. This Agreement shall be governed by and construed in accordance with the laws of the State of Florida, and venue for any legal proceeding or action at law arising out of or construing this Agreement shall lie in the state or federal courts of Orange County, Florida, and the parties specifically waive any other venue.

DISCLAIMER Not legal for sale or use on any pollution controlled motor vehicles. Legal in California only for racing vehicles which may never be used upon a highway.



**INDEX**

**2**

[www.DIABLOSPORT.COM](http://www.DIABLOSPORT.COM)



---

## **INSTALLATION INDEX**

---

<b><i>Make/Model</i></b>	<b><i>Year(s)</i></b>	<b><i>Pages</i></b>
<b><i>LIGHT DUTY TRUCKS</i></b>		
■ Ford Powerstroke 6.0L	2004.5-2007.5	1-3
■ Dodge 24 Valve 5.9L	2003-2006	4-6
■ Dodge Cummins 5.9L C.R.	2004-2007	7-8
■ Dodge 6.7L	2007.5+	9-14
■ GM LB7/LLY 6.6L	2001-2005	15-19
■ GM LBZ/LMM 6.6L	2006-2008	20-22
■ JEEP Liberty CRD	2005-2006	23-25

### ***MEDIUM DUTY TRUCKS***

■ Cummins 8.3L CAPS	1998-2005	26-28
■ Cummins 8.3L C.R.	2005-2007	29-30
■ LLY-Topkick 6.6L Duramax	2004-2007	31-33
■ 7.8L Duramax	2004.5+	34-36
■ CAT .C7/3126-C9 (1998-2005/2000-2007)		37-39
■ INT. DT444	1992-2002	40-41
■ INT. DT466/DT530/DT570	1997-2003.5	42-43
■ INT. DT466/DT530/DT570	2004-2006	44-45
■ INT. VT365	2003-2007	46

---

***INT. = International***

***CAT.= Caterpillar***

**CONTENT**

**3**

[www.DIABLOSPORT.COM](http://www.DIABLOSPORT.COM)

---

# CONTENTS

## INSIDE YOUR DIABLO BOX

---

1. One(1) DiabloSport Extreme PowerPuck
2. One(1) DiabloSport Extreme PowerPuck Wiring Harness
3. One(1) DiabloSport Extreme PowerPuck adjustable 3 position switch or One(1) DiabloSport Extreme PowerPuck adjustable "Diablo Dial" switch.
4. Two(2) Zip Ties
5. One(1) strip of velcro
6. One(1) small tube Dielectric Grease

\* Depending on your vehicle application, your DiabloSport Extreme PowerPuck may/may not include the following items:

Shim Kit

---

## CONTENTS INSIDE YOUR DIABLO BOX

---

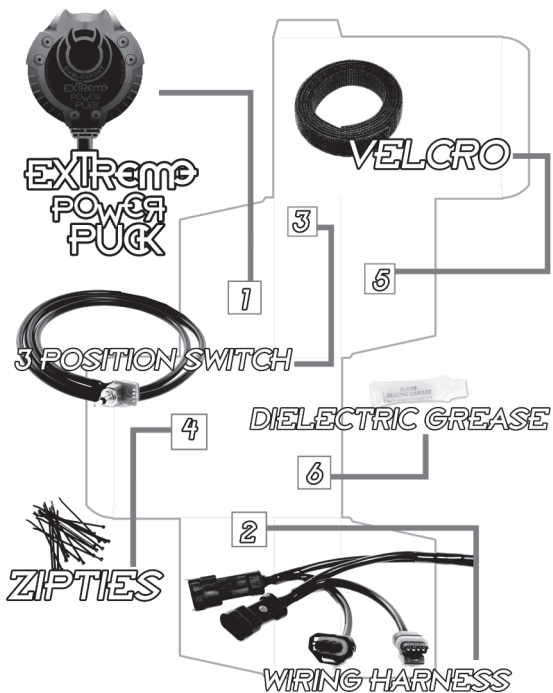

**Installation  
of the  
DIABLOSPORT  
EXTREME  
POWERPUCK**

**4**

[www.DIABLOSPORT.COM](http://www.DIABLOSPORT.COM)



---

## Pre-Installation Instructions

---

*Please be sure to read all instructions and have a complete understanding of them before you attempt to install you new DiabloSport Extreme PowerPuck.*

*Please make sure to disconnect the battery and remove your keys from the ignition before beginning the installation process*

*Before connecting any electrical components place a sufficient amount of Di-Electric grease onto each connection.*

**NEVER UN-PLUG YOUR EXTREME POWERPUCK FROM YOUR VEHICLE WHILE THE ENGINE IS RUNNING. THIS MAY CAUSE UNEXPECTED ERRORS / ENGINE FAILURES.**



*If there are any questions on the product or installation of the EXTREME POWERPUCK give us a call at DIABLOSPORT (1-800) 531-5484*

*To lessen the regeneration process frequency, turn Extreme Powerpuck back to stock in stop and go traffic. When going through regeneration process, turn the module to back to stock.*

---

## INSTALLATION

---

### Ford Powerstroke 6.0L 2004.5-2007.5

---

1. Find a desired location under the hood of your vehicle to mount the DiabloSport Extreme PowerPuck. Ensure that the location you pick is free from extreme heat, moisture, and has sufficient room for mounting. We have found a good place to mount the Puck is on the canister directly behind the passenger's side battery.
2. Route the adjustable switch through the firewall into the cab of your vehicle. Route the wire away from any moving devices and away from extreme heat that may burn the wire. Avoid cutting any factory wiring.

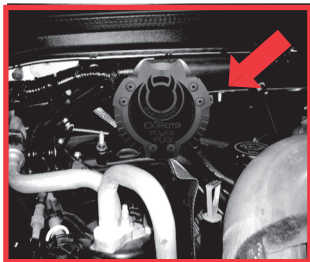



---

## INSTALLATION

---

3. Locate your vehicle's MAP sensor. This can be found on your vehicle's passenger side of the engine compartment. It should be mounted to the heater box by a metal plate.
4. Unplug your vehicle's factory harness from the MAP sensor and plug in the harness from your new DiabloSport Extreme PowerPuck.
5. Locate your vehicle's injection control pressure sensor. This can be found on the passenger's side valve cover. Disconnect the factory harness ensuring that the small key connector is removed as well. If the key connector does not come out with the harness simply use a small set of needle nose pliers to remove the key and insert it onto the factory connector.



---

## INSTALLATION

---

6. Unplug your vehicle's ICP sensor and plug the DiabloSport Extreme PowerPuck's harness into it.
  7. Mount the adjustable "Diablo Dial" in a convenient location inside the cab of your vehicle.
- 

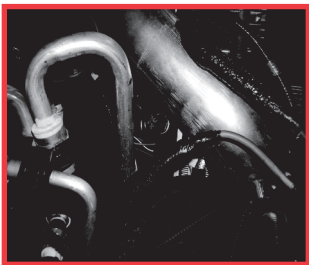

---

## INSTALLATION

---

### Dodge 5.9L 24 Valve 2003-2006

---

1. Using your supplied velcro strips securley mount the Extreme PowerPuck to a desired location. We recomend mounting the Extreme PowerPuck on top of the fuse and relay module. This module can be found on the drivers side of the engine compartment just in front of the battery.



2003-2006

Dodge 5.9L 24 Valve

---

## INSTALLATION

---

2. On the driver's side just next to the valve cover you will find your vehicle's MAP sensor. The sensor should have a blue weather tight seal around it. Disconnect the harness currently plugged into your MAP sensor and plug in the Extreme PowerPuck's harness.

3. Just in front of the MAP sensor you will find the Fuel Pressure Sensor (FPS). As you did in step 2, disconnect the current harness and plug in the Extreme PowerPuck's harness.

---



---

## INSTALLATION

---

4. Run the "Diablo Dial" switch wire through your vehicle's firewall to the DiabloSport Extreme PowerPuck
5. In a location of your choice, mount the "Diablo Dial" in you vehicle's cab
6. Reconnect your vehicle's battery and enjoy your drive!



---

## INSTALLATION

---

### Cummins 5.9L Common Rail 2004-2007

---

1. Inside you engine compartment you will see six steel lines that run directly to the injectors. Next to this you will find your Fuel Injection rail.
2. Once the fuel injection rail is located, find your vehicle's fuel pressure sensor. this will be on the actual fuel injection rail.
3. Unplug you vehicle's fuel pressure sensor and plug in your new DiabloSport Extreme PowerPuck into the sensor.
4. Plug in your vehicle's factory harness into the other side of the DiabloSport Extreme PowerPuck's harness.

---

## INSTALLATION

---

5. Using the included zip ties run the adjustable switch from the DiabloSport Extreme PowerPuck through the firewall into the cab of your vehicle making sure to route the cables away from any parts which may move and become entangled.
6. Mount the "DIABLO DIAL" in a convenient location.

---

Power increases as you turn the "DIABLO DIAL" clockwise

# 0-100 HORSEPOWER





---

## INSTALLATION

---

### Dodge 6.7L 2007.5+

---

1. Locate the plastic cover plate on top of the engine. Carefully remove the dipstick and 4 bolts holding the plastic cover plate.
2. After removing the plastic cover plate, locate the Exhaust Gas Recirculation tube. Using a 11mm wrench carefully remove the two clamps, which hold the EGR tube, in front of the valve cover without removing the EGR tube.

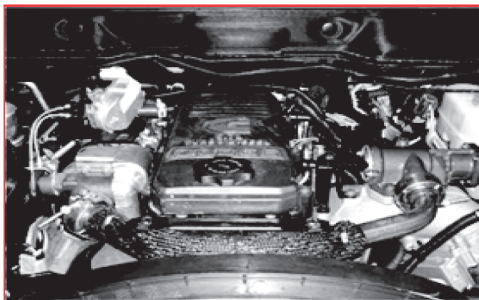



---

## INSTALLATION

---

3. Locate the single bolt which holds the dipstick tube to the bracket and the 6 bolts which hold the air horn to the manifold. Using a 10mm socket and wrench remove all 7 bolts. Carefully slide the air horn forward so the front of the fuel rail is accessible. Please be careful not to damage the gasket
4. Carefully remove the 18mm fuel rail valve. This valve can be found on the front of the fuel rail.

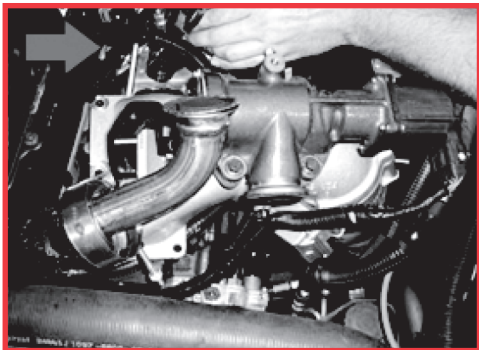

---

## INSTALLATION

---

5. Carefully screw the supplied nut tool onto the valve. Place the fuel rail valve into a vice. The vice should clamp down on the sides of the valve cap.

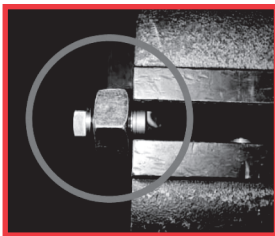

6. In order to remove the valve cap, carefully unscrew the nut. **CAUTION:** This piece is spring loaded. Be sure that you are holding the end of the valve while unscrewing to prevent a possible loss of parts. When removing the cap take note of how the holes inside the cap lined up with the spring.



---

## INSTALLATION

---

7. By carefully removing the metal spring you can now place the three supplied metal shims into the valve.

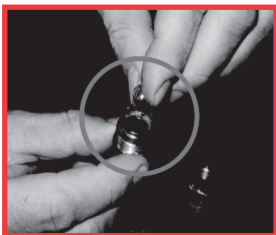

8. Place the spring back into the valve and replace the cap. NOTE: The inside of the valve cap has three holes which form the shape of a triangle. Do not remove this and ensure that these holes face towards the spring as they did when you removed it.



---

## INSTALLATION

---

9. To prevent damage to the valve seal surface, place the valve into the vice with a thick piece of cardboard or wood facing the valve cap.

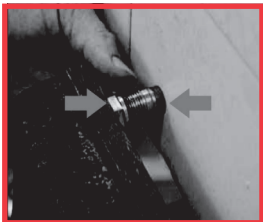

10. Using your small punch and hammer, carefully re-apply the 3 factory indentations to the valve lip. These indentations should be applied to the lip where the valve casing covers the valve cap. In order to rotate the valve you may need to loosen the vice. When doing this be sure not to allow the spring to push the cap out. After punching the three indentations, remove the valve and make sure the valve cap is held in place by your new indentations. If not, repeat step 9 & 10.

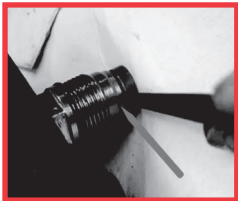

---

## INSTALLATION

---

11. Carefully re-install the fuel valve. Be sure to tighten the valve to 50 ft/lbs.
12. Line up the 6 bolt holes on the air horn with the 6 holes in the gasket and re-install the air horn. After the air horn is installed, re-connect the dipstick tube to the bracket on the air horn.
13. Carefully re-install the EGR tube. The easiest way to do this is to line up one side at a time and gently install the clamp leaving it loose enough for adjustment. Once both sides are gently clamped in place, ensure the EGR tube is in it's proper placement and tighten both sides.
14. On the back of the fuel rail close to the fire wall you should see the fuel pressure sensor. After locating this sensor plug the factory connector into the Extreme PowerPuck's harness. Plug the other side of the Extreme PowerPuck's harness into the fuel pressure sensor.
15. Connect the harness to your DiabloSport Extreme PowerPuck and using the provided velcro strips mount the Extreme PowerPuck in a convenient location.
16. Run the switch wire through the firewall and plug it into the Extreme PowerPuck. Mount the switch in the cab where you would have easy access while driving.
17. Drive and enjoy.

---

## INSTALLATION

---

### GM Duramax LB7 & LLY 6.6L 2001-2005

---

1. Find a desired location under the hood of your vehicle to mount the DiabloSport Extreme PowerPuck. Ensure that the location you pick is free from extreme heat, moisture, and has sufficient room for mounting.
2. Route the adjustable switch through the firewall into the cab of your vehicle. Route the wire away from any moving devices and away from extreme heat that may burn the wire. Avoid cutting any factory wiring.



---

## INSTALLATION

---

3. Locate your vehicle's MAP sensor.
4. For LB7 Applications the MAP sensor will be located under your vehicle's air intake module on top of the vehicle's engine. In order to access the MAP sensor you will need to remove the intake box and tube.
5. For LLY Applications the MAP sensor will be located directly behind your vehicle's AC compressor. In order to access the MAP sensor you might need to remove the belt and the bolts (15mm) holding the compressor in place. **CAUTION:** Do not remove any of the lines leading into the compressor. After the bolts have been removed just move the compressor slightly to the side.

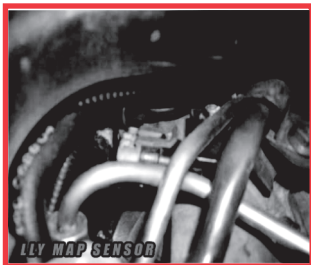

---

## INSTALLATION

---

6. Unplug your vehicle's factory harness from the MAP sensor and plug in the harness from your new DiabloSport Extreme PowerPuck. If you removed your AC-compressor re-attach your AC compressor with the bolts you removed and put the belt back on.
7. Locate your vehicle's fuel pressure sensor.

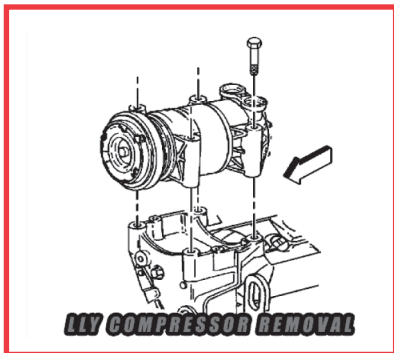



---

## INSTALLATION

---

8. For LB7 applications the Fuel Pressure Sensor is located just below the intercooler tube. You will need to remove the intercooler tube itself to expose the sensor. after plugging in the harness be sure to reconnect the tube)

9. For LLY applications the Fuel Pressure Sensor is located just below the air intake tube on the passenger's side of the engine (see picture).

10. Unplug your vehicle's factory harness from the fuel pressure sensor and plug in the harness from your new DiabloSport Extreme PowerPuck.

---

\*Please See Graphic references on next page

## INSTALLATION

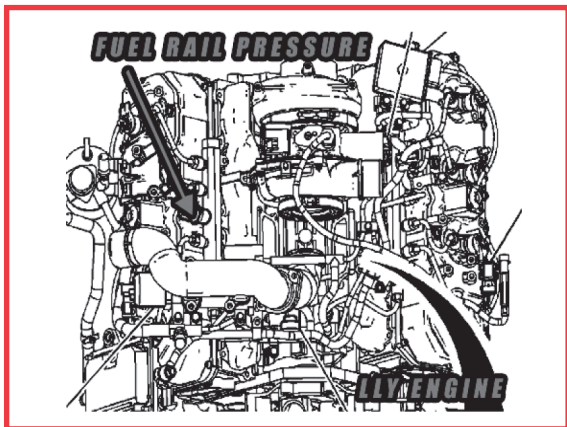
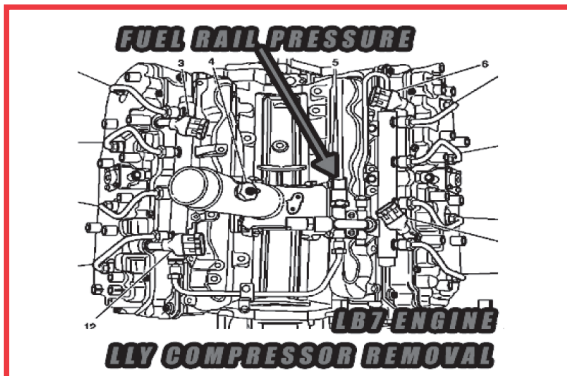

---

## INSTALLATION

---

### GM Duramax LBZ & LMM 6.6L 2006-2008

---

1. Find a desired location under the hood of your vehicle to mount the DiabloSport Extreme PowerPuck. Ensure that the location you pick is free from extreme heat, moisture, and has sufficient room for mounting.
2. Route the adjustable switch through the firewall into the cab of your vehicle. Route the wire away from any moving devices and away from extreme heat that may burn the wire. Avoid cutting any factory wiring.
3. Locate your vehicle's MAP sensor. The sensor should be located just in front of the air intake manifold tube which is located in front of the vehicle's engine.(see picture)
4. Unplug your vehicle's factory harness from the MAP sensor and plug in the harness from your new DiabloSport Extreme PowerPuck.

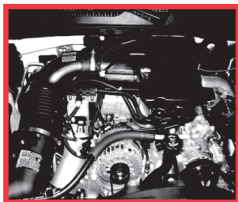

## INSTALLATION

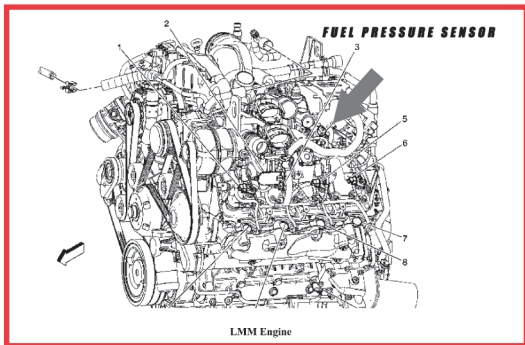

5. Locate your vehicle's fuel pressure sensor. If sensor is found on the back of the fuel rail on the passenger side of the engine. See attached diagram for location of this sensor.

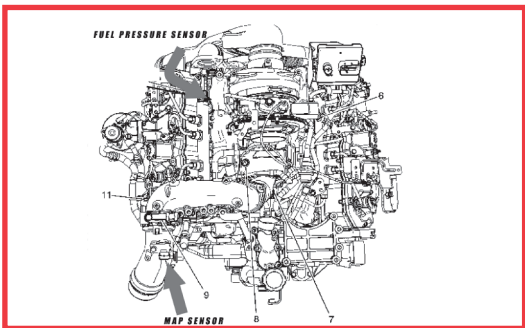

---

## INSTALLATION

---

6. Unplug your vehicle's factory harness from the fuel pressure sensor and plug in the harness from your new DiabloSport Extreme PowerPuck.
7. Mount the adjustable "Diablo Dial" in a convenient location inside the cab of your vehicle.

---

2006-2008



GM Duramax LBZ & LMM 6.6L

---

## INSTALLATION

---

### JEOP Liberty CRD 2005-2006

---

1. Find a desired location under the hood of your vehicle to mount the DiabloSport Extreme PowerPuck. Ensure that the location you pick is free from extreme heat, moisture, and has sufficient room for mounting. We have found a good place to mount the Puck is on the fuse box located on the driver's side of the engine compartment directly in front of the battery.
2. Route the adjustable switch through the firewall into the cab of your vehicle. Route the wire away from any moving devices and away from extreme heat that may burn the wire. Avoid cutting any factory wiring.

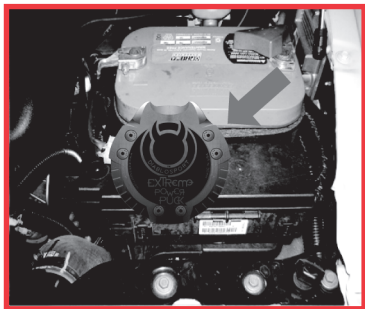

---

## INSTALLATION

---

3. Locate and remove your vehicle's oil fillet cap and plastic engine cover. This will expose the sensors which you will need access to.(be sure to re-install the cap and cover after step 4 is completed)
4. Look for a connector with a blue weather seal. This is the MAP sensor. It can be found toward the back of the engine compartment atop the firewall just under the wipers on the driver's side.
5. Unplug your vehicle's factory harness from the MAP sensor and plug in the harness from your new DiabloSport Extreme PowerPuck.

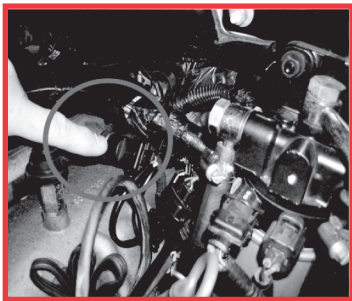

---

## INSTALLATION

---

6. Locate your vehicle's fuel pressure sensor. This can be found just in front of the MAP sensor connector. It should have an orange indicator when disconnected
7. Unplug your vehicle's factory harness from the fuel pressure sensor and plug in the harness from your new DiabloSport Extreme PowerPuck
8. Mount the adjustable "Diablo Dial" in a convenient location inside the cab of your vehicle.

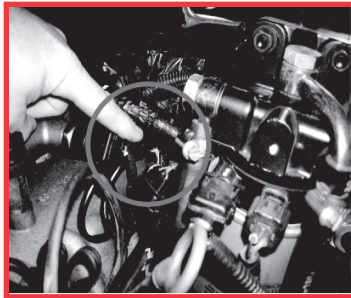



---

## INSTALLATION

---

### Cummins 8.3L CAPS 1998-2005

---

1. Locate you vehicle's fuel pump. It can be found by locating the six large steel lines that run to your vehicle's injectors.
  2. On the back side of the fuel pump you will find you Vehicle's fuel pressure sensor. The connection should Look identical to the connector on the DiabloSport PowerPuck Extreme's harness.
  3. Unplug you vehicle's fuel pressure sensor and plug in the DiabloSport Extreme's PowerPuck harness
  4. Now plug your vehicle's harness into the other side of The DiabloSport Extreme PowerPuck's harness.
- 

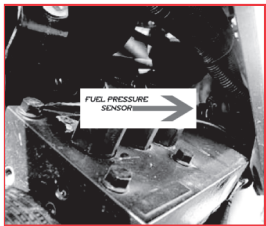

---

## INSTALLATION

---

5. Using the picture below as a reference, locate your vehicle's MAP sensor
6. Unplug your vehicle's factory map sensor and plug in the harness From you new DiabloSport Extreme PowerPuck into the MAP sensor.
7. Taking the leftover connector plug it into the factory harness
8. Mount the DiabloSport Extreme PowerPuck in a safe location Using the supplied Zip Ties/Velcro
9. Route the adjustable switch through the firewall into the cab of your vehicle. Plug the connector into the DiabloSport Extreme PowerPuck.

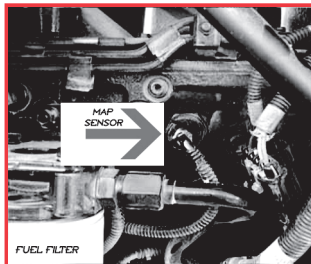

---

## INSTALLATION

---

10. Mount the adjustable “Diablo Dial” in a convenient location inside the cab of your vehicle.

---

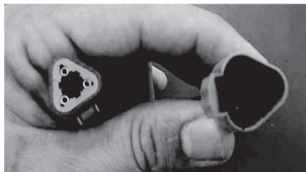

---

## INSTALLATION

---

### Dodge Cummins 8.3L Common Rail 2005-2007

---

1. Inside you engine compartment you will see six steel lines that run directly to the injectors. Next to this you will find your Fuel Injection rail.
2. Once the fuel injection rail is located, find your vehicle's fuel pressure sensor. This will be on the actual fuel injection rail.
3. Unplug you vehicle's fuel pressure sensor and plug in your new DiabloSport Extreme PowerPuck into the sensor.
4. Plug in your vehicle's factory harness into the other side of the DiabloSport Extreme PowerPuck's harness
5. Using the included zip ties route the cables away from any parts which may move and become entangled.

---

## INSTALLATION

---

6. Run the adjustable switch from the DiabloSport Extreme PowerPuck through the firewall into the cab of your vehicle.
7. Mount the switch in a convenient location.

---

Power increases as you turn the "DIABLO DIAL" clockwise

# 0-100 HORSEPOWER



---

## INSTALLATION

---

### GM Duramax LLY Topkick 6.6L 2004-2007

---

1. Find a desired location under the hood of your vehicle to mount the DiabloSport Extreme PowerPuck. Ensure that the location you pick is on the driver's side and is free from extreme heat, moisture, and has sufficient room for mounting.
2. Locate your vehicle's MAP sensor. See diagram for location of this sensor.
3. Unplug your vehicle's factory harness from the MAP sensor and plug in the harness from your new DiabloSport Extreme PowerPuck.

## INSTALLATION

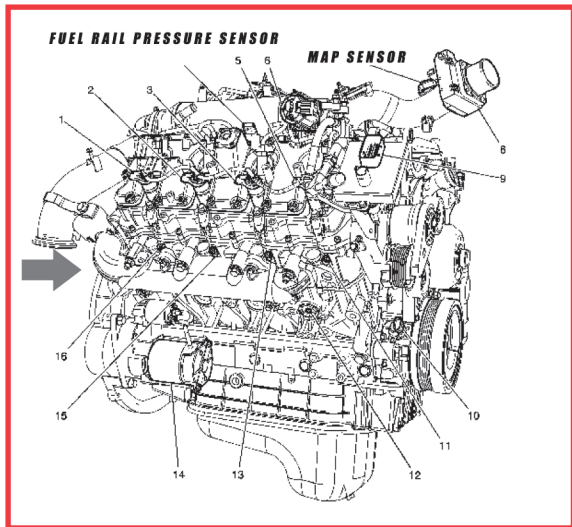

4. Locate your vehicle's fuel pressure sensor. The fuel pressure sensor should be located on the back of the fuel rail, on the passenger side.

---

## INSTALLATION

---

5. Unplug your vehicle's fuel pressure sensor and plug the DiabloSport Extreme PowerPuck's harness into it.
6. Route the adjustable switch through the firewall into the cab of your vehicle. Plug the connector into the DiabloSport Extreme PowerPuck.
7. Mount the adjustable "Diablo Dial" in a convenient location inside the cab of your vehicle.

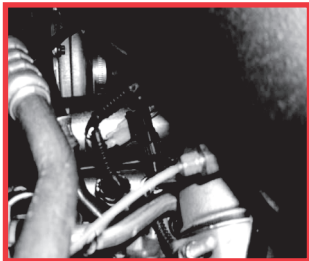



---

## INSTALLATION

---

### DURAMAX 7.8L 2004.5-2007.5

---

1. Find a desired location under the hood of your vehicle to mount the DiabloSport Extreme PowerPuck. Ensure that the location you pick is on the driver's side and is free from extreme heat, moisture, and has sufficient room for mounting.
  2. Locate your vehicle's MAP sensor. This can be found by locating your vehicle's intercooler and following it to the manifold. The MAP sensor is located on the manifold. See Picture Below.
- 



---

## INSTALLATION

---

3. Unplug your vehicle's factory harness from the MAP sensor and plug in the harness from your new DiabloSport Extreme PowerPuck.
4. Locate your vehicle's fuel rail. Once your fuel rail is located you should be able to find the fuel pressure sensor (see picture)



---

## INSTALLATION

---

5. Unplug your vehicle's injection control pressure sensor and plug the DiabloSport Extreme PowerPuck's harness into it
6. Route the adjustable switch through the firewall into the cab of your vehicle. Plug the connector into the DiabloSport Extreme PowerPuck.
7. Mount the adjustable "Diablo Dial" in a convenient location inside the cab of your vehicle.



---

## INSTALLATION

---

### Caterpillar C7/3126-C9 1998-2005/2000-2007

---

1. Find a desired location under the hood of your vehicle to mount the DiabloSport Extreme PowerPuck. Ensure that the location you pick is free from extreme heat, moisture, and has sufficient room for mounting. We have found a good place to mount the Puck is on the driver's side.
2. Route the adjustable switch through the firewall into the cab of your vehicle. Route the wire away from any moving devices and away from extreme heat that may burn the wire. Avoid cutting any factory wiring.

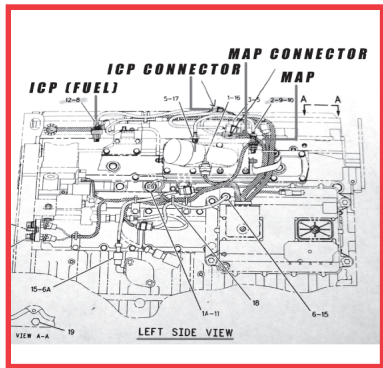

# INSTALLATION

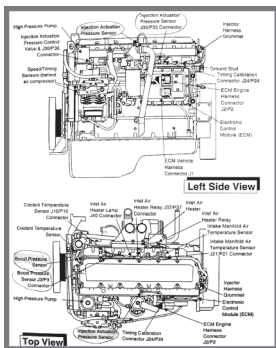

3. Locate your vehicle's fuel pressure sensor(ICP). This sensor can be found on the driver's side of the engine block on the front side of the engine. The sensor can be identified by white, brown, and green wires.

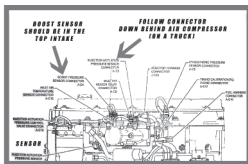

4. Unplug your vehicle's factory harness from the fuel pressure sensor and plug in the harness from your new DiabloSport Extreme PowerPuck.

38

DIABLOSPORT  
GASOLINE AND DIESEL TUNING SYSTEMS

1998-2005 / 2000-2007 CAT. C1/3126 - G9



DIABLOSPORT  
GASOLINE AND DIESEL TUNING SYSTEMS

1998-2005 / 2000-2007 CAT. C7/3126 - C9

---

## INSTALLATION

---

5. To locate your vehicle's MAP sensor, simply locate the intake manifold. This should be located on the rear of the engine closer to the driver's side next to the valve cover. The MAP sensor can usually be identified by finding the sensor with green, white, and pink wires.
6. Unplug your vehicle's factory harness from the MAP sensor and plug in the harness from your new DiabloSport Extreme PowerPuck.
7. Mount the adjustable "Diablo Dial" in a convenient location inside the cab of your vehicle.

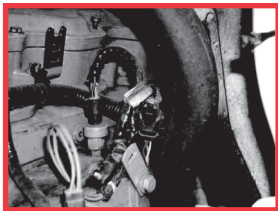
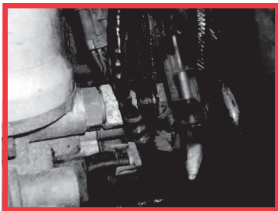

---

## INSTALLATION

---

### International DT444 1992-2002

---

1. Find a desired location under the hood of your vehicle to mount the DiabloSport Extreme PowerPuck. Ensure that the location you pick is free from extreme heat, moisture, and has sufficient room for mounting. We have found a good place to mount the Puck is on the driver's side.
2. Route the adjustable switch through the firewall into the cab of your vehicle. Route the wire away from any moving devices and away from extreme heat that may burn the wire. Avoid cutting any factory wiring.

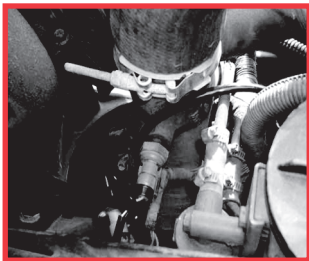

---

## INSTALLATION

---

3. Locate your vehicle's fuel pressure sensor(ICP). This sensor can be found on the driver's side of the engine block on the front side of the engine. You will see a tube running from the intercooler to the engine. The fuel pressure sensor is located under this tube.
4. Unplug your vehicle's factory harness from the fuel pressure sensor and plug in the harness from your new DiabloSport Extreme PowerPuck.

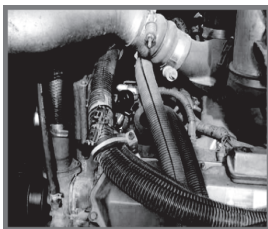
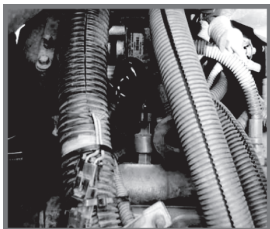

5. Mount the adjustable "Diablo Dial" in a convenient location inside the cab of your vehicle.



---

## INSTALLATION

---

### International DT466/DT530/DT570 1997-2003.5

---

1. Find a desired location under the hood of your vehicle to mount the DiabloSport Extreme PowerPuck. Ensure that the location you pick is free from extreme heat, moisture, and has sufficient room for mounting. We have found a good place to mount the Puck is on the fuse box located on the driver's side.

2.a Route the adjustable switch through the firewall into the cab of your vehicle. Route the wire away from any moving devices and away from extreme heat that may burn the wire. Avoid cutting any factory wiring.



---

## INSTALLATION

---

2.b Locate your vehicle's fuel pressure sensor. This sensor can be found on the driver's side of the engine block. If your vehicle is the DT466E the sensor can be found behind a computer next to the engine block.

3. Unplug your vehicle's factory harness from the fuel pressure sensor and plug in the harness from your new DiabloSport Extreme PowerPuck.

---

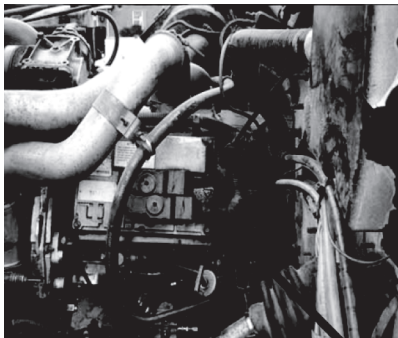

---

## INSTALLATION

---

### International DT466, DT530, DT570 2004-2006

---

1. Find a desired location under the hood of your vehicle to mount the DiabloSport Extreme PowerPuck. Ensure that the location you pick is free from extreme heat, moisture, and has sufficient room for mounting. We have found a good place to mount the Puck is on the driver's side.
2. Route the adjustable switch through the firewall into the cab of your vehicle. Route the wire away from any moving devices and away from extreme heat that may burn the wire. Avoid cutting any factory wiring.
3. Locate your vehicle's fuel pressure sensor(ICP). This sensor can be found on the driver's side of the engine block on the rear side of the engine.
4. Unplug your vehicle's factory harness from the fuel pressure sensor and plug in the harness from your new DiabloSport Extreme PowerPuck.

---

## INSTALLATION

---

5. Locate your vehicle's MAP sensor(see diagram). The MAP sensor should be located on the same side as the ICP sensor slightly toward the front of the engine.
6. Unplug your vehicle's factory harness from the MAP sensor and plug in the harness from your new DiabloSport Extreme PowerPuck.
7. Mount the adjustable "Diablo Dial" in a convenient location inside the cab of your vehicle.

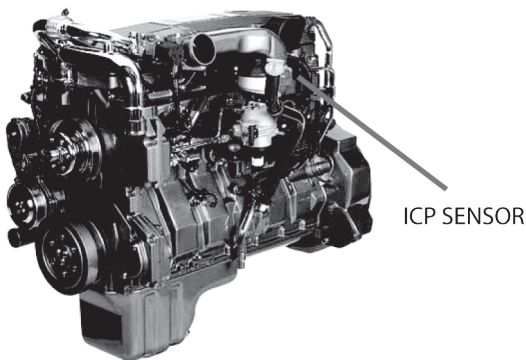

---

## INSTALLATION

---

### International VT 365 2003-2007

---

1. Find a desired location under the hood of your vehicle to mount the DiabloSport Extreme PowerPuck. Ensure that the location you pick is free from extreme heat, moisture, and has sufficient room for mounting. We have found a good place to mount the Puck is on the driver's side.
2. Route the adjustable switch through the firewall into the cab of your vehicle. Route the wire away from any moving devices and away from extreme heat that may burn the wire. Avoid cutting any factory wiring.
3. Locate your vehicle's fuel pressure sensor. This sensor can be found on the driver's side of the engine block directly behind the turbo for 2003-2004.5 trucks. You will need to remove the Fuel Pressure Sensor inspection plate first. If your vehicle is newer than 2004.5 the sensor can be found on the passenger side cylinder head.
4. Unplug your vehicle's factory harness from the fuel pressure sensor and plug in the harness from your new DiabloSport Extreme PowerPuck.
5. Mount the adjustable "Diablo Dial" in a convenient location inside the cab of your vehicle.



**DIABLOSPORT®**  
GASOLINE AND DIESEL TUNING SYSTEMS

SALES: 1-800-396-6614

TECH: 1-800-531-5484

[www.DIABLOSPORT.com](http://www.DIABLOSPORT.com)