

#12

AirDog II DF-200

FUEL PREPARATOR

INSTALLATION MANUAL

FOR 12V CUMMINS POWERED

DODGE TRUCKS

1994-1998.5

**HIGH PERFORMANCE FUEL SYSTEM
WITH QUICK CONNECT COMPONENTS**

**PLEASE READ THESE INSTRUCTIONS THOROUGHLY
BEFORE BEGINNING THE INSTALLATION**



**PUREFLOW AIRDOG
705 W MAUSOLEUM RD.
SHELBYVILLE, IN 46176**

**877-421-3187
PUREFLOWAIRDOG.COM**

CANADIAN PATENT
2,108,391

PROTECTED BY
US PATENTS
5,355,860; 5,746,184; 6,729,310

AUSTRALIAN PATENT
2005101054

NEW ZEALAND PATENT
532356

Additional Foreign Patents Pending in Europe, South America, Mexico, Japan, and China!



SMALL and COMPACT
7" Long X 3.2" Wide X 10" Tall

OVERVIEW

Thank you for your purchase and welcome to PureFlow AirDog's AirDog®II-4G fuel air separation and delivery system for the 1994-1998.5 Cummins 12V diesel engine.

The AirDog®II-4G Fuel Preparator® is an all in one premium high pressure fuel pump and filtration system for the 5.9L Cummins diesel. The system removes water, particulates, and entrained air from the diesel fuel. The entrained air that is separated from the fuel is returned to the tank through a small return line. The fuel is delivered to the engine at the correct pressure and flow rate to meet the demands of the engine under all operating conditions.

The AirDog®II-4G DF-200 systems feature a built in adjustable pressure regulator. All AirDog®II and AirDog®II-4G systems include a complete installation kit.

The AirDog®II-4G for this particular application are preset at 25-30psi from factory for a stock application. The regulator is adjustable up to 35 psi for fine tuning the system for performance upgrades. **WARNING: RUNNING THE PUMP ABOVE 35PSI WILL DECREASE THE LIFE OF THE PUMP SIGNIFICANTLY AND MAY VOID THE WARRANTY.**

PureFlow AirDog products are manufactured in Shelbyville Indiana by a team of skilled workers with unsurpassed attention to detail and using the most stringent quality assurance.

TYPICAL INSTALLATION LAYOUT

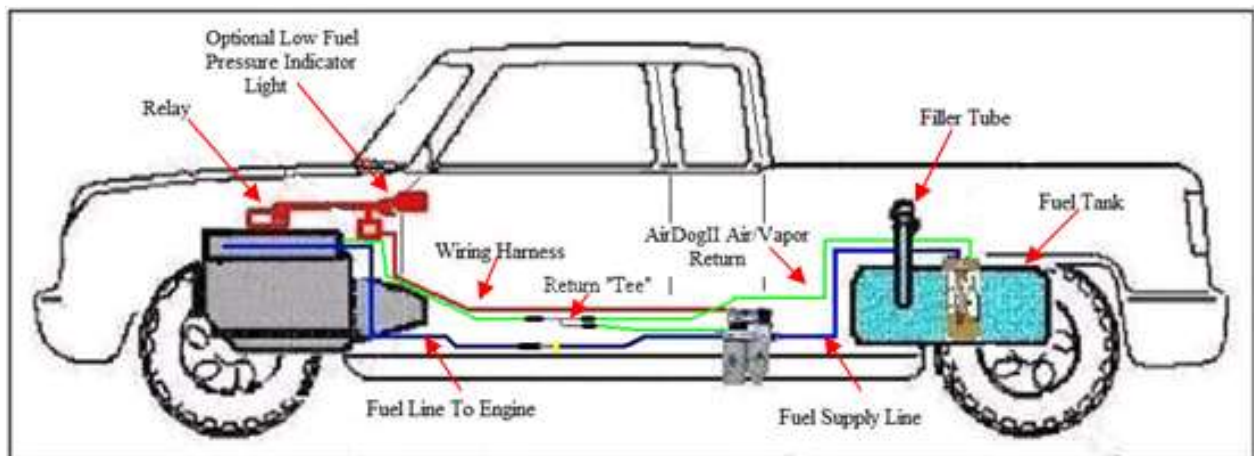

The AirDog®II-4G draws fuel from the fuel tank at a constant flow, removing water, particulates, and air/vapor. A regulated pressurized flow is maintained to meet the engine's varying fuel demands. The The AirDog®II-4G returns the separated air/vapor to the fuel tank through the vehicle's original return line.

NOTE: The pictures used in this manual are for example only and may not be exactly the same as your truck.

QUICK CONNECT COMPONENT OVERVIEW

Provided in this kit is an OE style quick connection system. This system works to allow for a quick, clean, and professional install.

SAE J2044 Quick Connect System

The SAE J2044 quick connect system is the most commonly used system in the automotive industry. The images below show the formation of SAE J2044 connection. To connect the assemblies, simply insert the male end form into the mating female connector. Push firmly until you hear it “click” into place. To disconnect the fittings, press down and hold the tabs on the female connector while you firmly pull the assembly apart.



TABLE OF CONTENTS

Section 1.....Table of Contents

Section 2.....Installation & Safety Guidelines

Section 3.....Parts List

INSTALLATION PROCEDURES

Section 4.....Fittings, Brackets, and Mounting

FUEL LINES

Section 5.....Fuel Line Assembly

Section 6A.....Fuel Line To Engine

Section 6B.....Injection Pump Return Line

Section 6C.....Return Line to Tank

Section 6D.....Suction Line from Tank

ELECTRICAL HARNESS

Section 7.....Wiring Harness

Section 8.....Initial Start Procedure

MAINTENANCE

Section 9.....Fuel Filter and Water Separator

Section 10.....Cleaning the Gerotor Assembly

Section 11.....Adjusting the Pressure Regulator

Section 12.....AirDog®II Parts

Section 13.....Fuel Filter Service

Section 14.....Warranty Procedure

AirDog® II MODEL DF-200

The installation of your AirDog® II can be made relatively easy by following the steps outlined in this manual, and:

1. Inventory the package components completely. Notify *PUREFLOW AIRDOG* immediately of any parts missing or damaged.
2. Read the installation manual completely. Understand how the system operates and take note of installation recommendations before beginning installation.
3. The installation recommendations contained herein are suggested installation guidelines only. Individual installations may vary.

SAFETY GUIDELINES!

CAUTION! Be sure to chock the vehicle's tires to prevent rolling.

CAUTION! Use proper supports when working beneath an elevated vehicle.

CAUTION! Most diesel pickups have two (2) 12volt batteries. Disconnect the battery cables to both batteries before proceeding with the AirDog® II installation.

CAUTION! Vehicle frame rails should not be drilled into or welded upon.

CAUTION! Wear safety glasses when operating power tools such as drills and grinders or when using a punch or chisel.

CAUTION! Use common sense when routing fuel lines and electrical harnesses. Keep them away from hot exhaust components and/or moving parts. Properly secure lines to prevent chaffing.

NOTE: The pictures used in this manual are for example only and may not be exactly the same as your truck.

AirDog® II DF-200 Parts List

QTY	DESCRIPTION	PART NUMBER	IMAGE
1	AirDog® II-4G	DF-200	
1	AirDog® II Bracket	001-3C-0004	
1	Mounting Hardware Kit,	901-61-0102-PM	
1	Frame Bracket Set	010-3C-0002 010-3C-0001	
1	Wiring Harness	5E-2-010	
1	Bundle of Plastic Ties	5H-2-1-06/12	
1	Return Fuel Filler Tube Assembly (1-3/4" OD w/2 Clamps)	001-4A-1-0175	
1	Spacer	010-3C-0003-A-P	
1	20ft of Fuel Line	HS20	
4	1/2" Straight Hose Quick Connect Fitting	FQC12S	
1	1/2" 90° Hose Quick Connect Fitting	FQC1290	
1	3/8" 90° Hose Quick Connect Fitting	FQC3890	
1	14mm X 1/2" male SAE J2044 Fitting	WAP103	
1	Sealing Washer (installs on WAP103 fitting)	1P-5-ES	
1	Customer Service Oring Replacement Kit	901-05-0100	
2	1/2" Male J2004 Quick Connect x 9/16" UNF	08J2044916UNF	
1	3/8" Male J2004 Quick Connect x 5/16" UNF	06J2044516UNF	
2	5/16" Push Lock X 1/4" Male NPT	4A-1-18-05-04	
1	Injection Pump Return Tee	001-4A-1-0008	
1	"P" Pump Flexible Return Line	4C-1-02-05-001	
1	High Flow Suction Tube	WAP108	
1	Grommet	5J-1-1-04-0001	

ILLUSTRATION OF QUICK CONNECT COMPONENTS

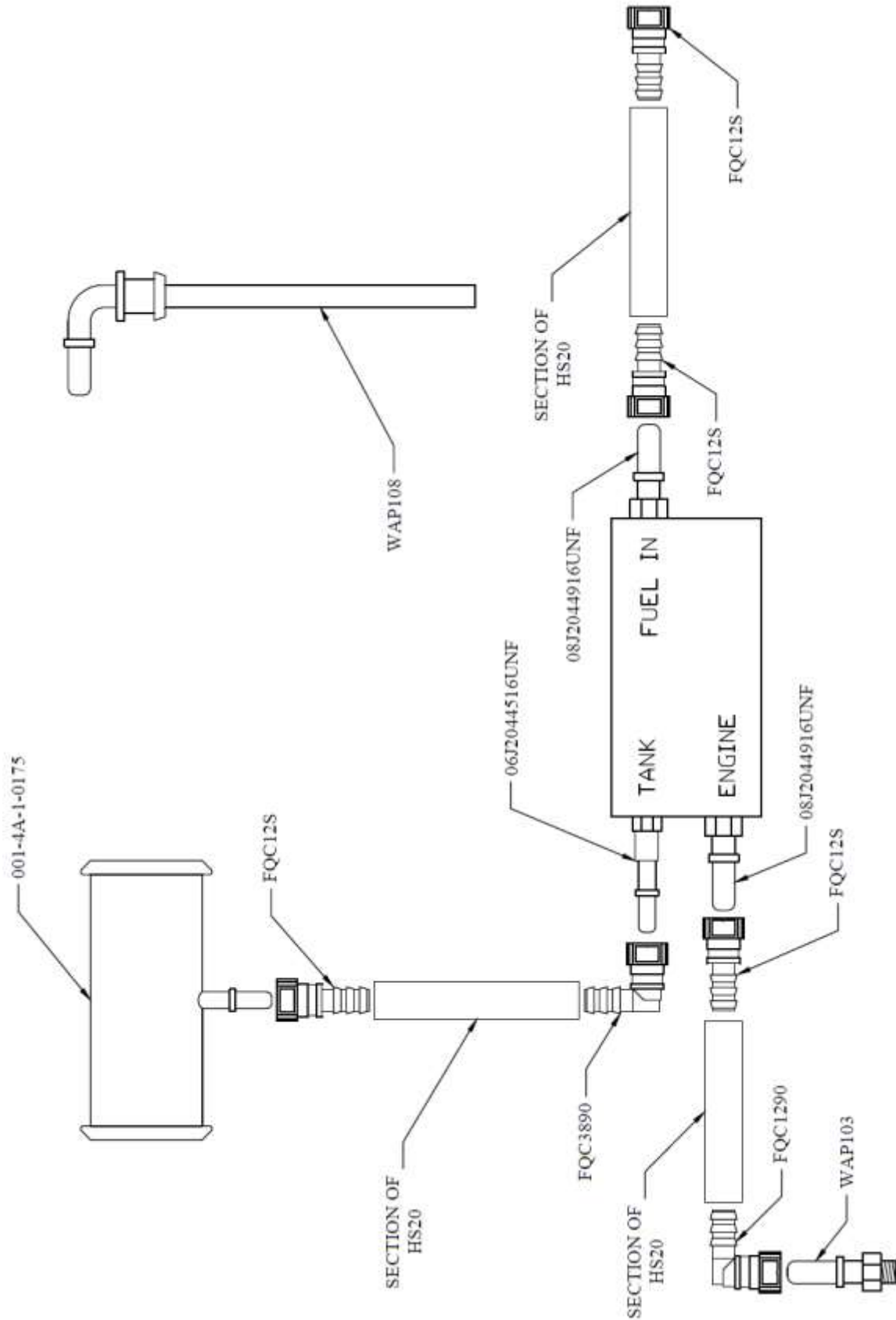

Installing the j2044 Quick Connect Fittings into the AirDog® II OR AirDog® II-4G Filter Base

- 4-1. Dip the threaded end of the 1/2" male J2044 quick connect X 9/16" UNF (08J2044916UNF) fittings into clean motor oil and hand-thread into the "ENGINE" and "FUEL IN" ports of the AirDog® II-4G filter base as illustrated in figures 1, 2, and 3. Using a 3/4" deep socket, torque the fittings to 120in-lb or 10ft-lb. **DO NOT overtighten the fittings or damage may occur!**
- 4-2. Dip the threaded end of the 3/8" male J2044 quick connect X 5/16" UNF (06J2044516UNF) fitting into clean motor oil and hand-thread into the return port of the the AirDog® II-4G filter base as illustrated in figures 1 and 4. Using a 5/8" deep socket, torque the fitting to 60in-lb or 5ft-lb. **DO NOT overtighten the fittings or damage may occur!**

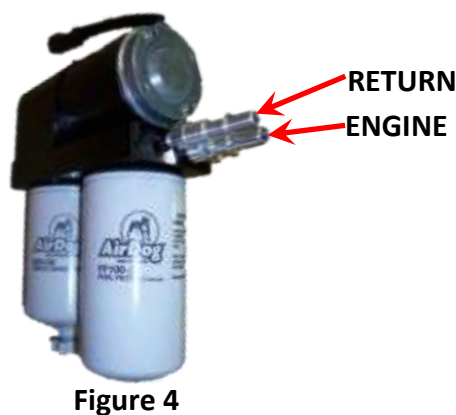
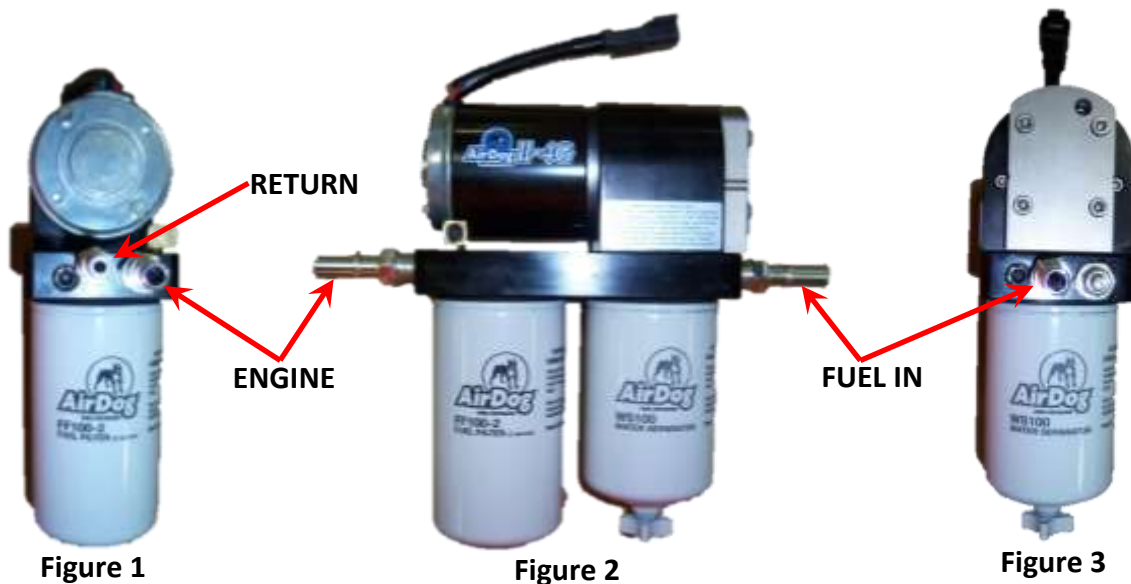

- 4-3. Assemble the AirDog mounting bracket (001-3C-0004) to the frame bracket (010-3C-0001) using the spacer (010-3C-0003-A-P) as shown in figure 5 using the four bolts, lock washers, and nuts included in the mounting bracket hardware kit (figure 6). Properly torque all fasteners! You will need a 3/16" allen and a 1/2" wrench. The bracket assembly should look like figure 7.



Figure 5



Figure 6



Figure 7

- 4-4. Attach the AirDog®II-4G to the frame bracket assembly as shown in figure 8 using the supplied hardware in the mounting bracket hardware kit.



Figure 8

NOTE: We recommend installing the AirDog® on the inside of the frame rail, but we understand some applications just don't have the room. The photos in this manual may not be the same as your application.

- 4-5. Be sure to tuck the AirDog®II-4G as far up as possible without it rubbing on anything to prevent damage from road debris. The bracket assembly is adjustable to achieve this.

NOTE: Some pickup model frame rails have a bracket that is used to support the frame during the manufacturing process. If this bracket is on your frame rail and obstructs the proper positioning of the AirDog® II mounting bracket, you may remove part or all of it, as needed. Be very careful not to damage the frame flange!



Figure 9

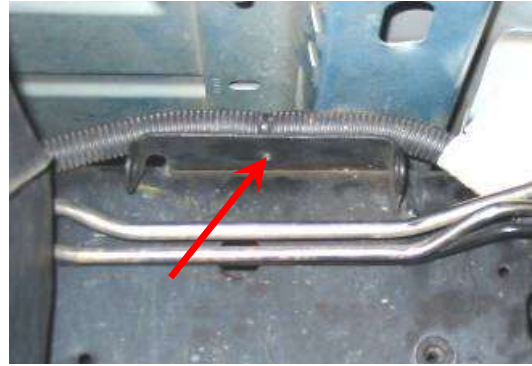

Figure 10

4-6. Clamp the frame between the AirDog® bracket assembly and the backing plate (figure 11) using the 3/8" bolts, lock washers, and nuts included in the kit. You will need two 9/16" wrenches. Properly torque all fasteners! **BE SURE** to mount the AirDog®II with the "FUEL IN" port toward the rear of the vehicle (Figure 12).



Figure 11



Figure 12

Assembling the Fuel Lines

This kit includes a length of fuel line and separate fuel line ends to allow for much cleaner looking installations! Assemble the fuel lines as you install them. You won't want to pre-assemble the hoses or your lengths may be off.

- 5-1. Take the fuel line end and lubricate the barbed end with clean motor oil (Figure 13) and press it into the fuel line (HS20) until all three barbs are covered (Figures 14 and 16). The fuel line end should look like Figure 15.



Figure 13



Figure 14



Figure 15

- 5-2. Now plug that fuel line with that fitting into the connection on the either the AirDog or the truck where the manual calls it out.
- 5-3. Run the fuel line along the frame away from any hot or moving parts such as exhaust or the driveshaft (Figure 16). Cut the hose to length and insert the other fuel line end that the manual calls out into the fuel line as outlined in step 5-1.



Figure 16

NOTE: Hose clamps are not needed for these push-lock connectors.

Installing the Fuel Supply Line from the AirDog® to the Injection Pump

When installing the AirDog® fuel system, it is recommended to bypass the factory filter canister for optimum engine performance.

6A-1. Remove the 14mm banjo bolt and original factory fuel supply line at the fuel inlet port of the P-7100 pump (Figure 17).

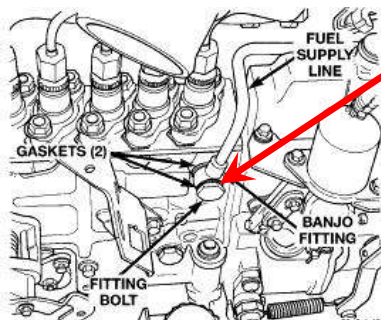

Figure 17

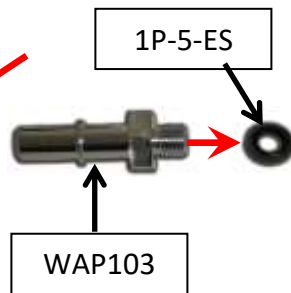

Figure 18

6A-2. Install the 14mm x ½" male SAE J2044 (WAP 103) fitting with the seal washer (1P-5-ES) supplied into the inlet port of the injector pump (Figure 18) once the original fitting is removed. **Do not over tighten the fitting. It may crack or break.** Either remove or bend the original supply line out of the way.

6A-3 Assemble one end of the hose (Reference section 5) using Fuel line end FQC1290 and plug it into the WAP103 fitting installed in the previous step. A "click" will be heard once the fitting is properly connected.

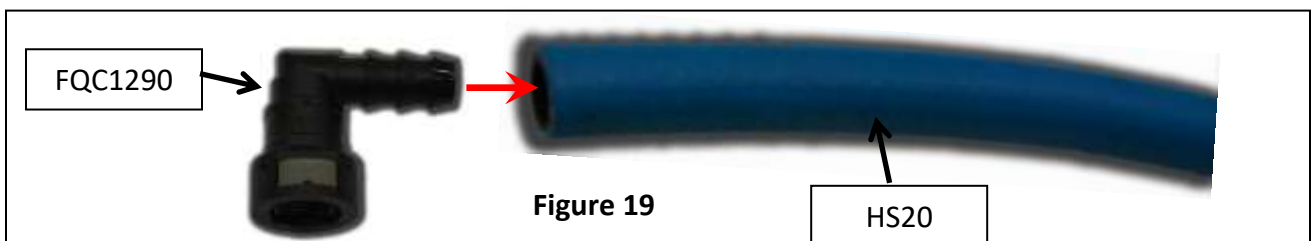

Figure 19

6A-4. Run the fuel line along the frame as mentioned in step 5-3 to the "Engine" port in the AirDog®. Cut the fuel line to length and insert fuel line end FQC12S per step 5-1. Once the connector is installed, connect it to the male J2044 fitting in the "Engine" port in the AirDog®. A "click" will be heard once properly connected.

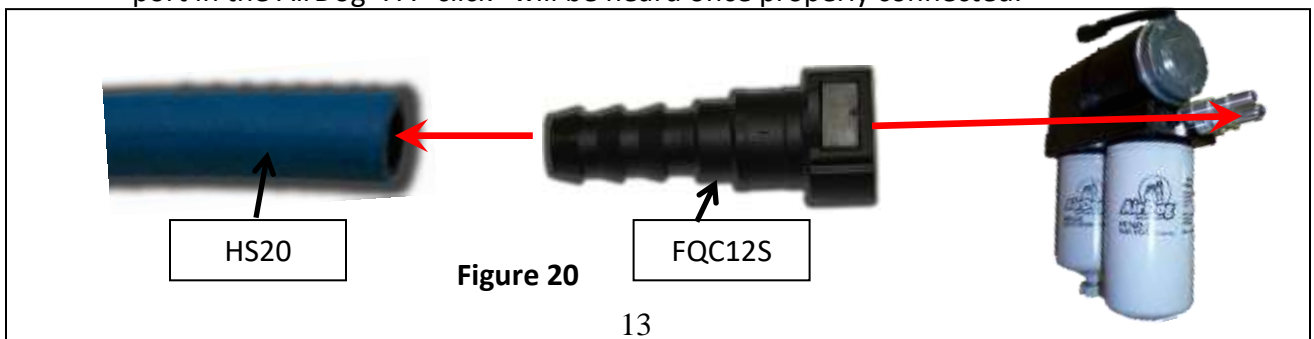

Figure 20

P-7100 Injector Pump and Injector Bleed Line Return to Tank

NOTE: Fuel is returned from the P-7100 fuel pump and also from the injector bleed line(s). The original 12 Valve Cummins fuel system returns the fuel from the P-7100 injector pump directly to the fuel tank while the injector bleed line is routed to the inlet port of the filter head to be recycled back to the engine. When installing the AirDog®, it is best to route the fuel from the injector bleed line back to the fuel tank as well.



Figure 21

Return Line From the P-7100 Pump



Figure 22

End of steel line from the P-7100 that connects to the tank return line.



Figure 23

Injector Bleed Line that connects to the tank return line.

6B-1. Disconnect the injector bleed line (Ref. Fig. 23) by removing the 8 mm banjo bolt. Be careful to not misplace the O-ring washer that seals the banjo fitting.

6B-2. Disconnect and remove the 8 mm banjo fitting and metal fuel line connecting the fuel pump to the filter head. Either remove the line or bend it out of the way as it will no longer be used.



Figure 24

6B-3. Remove the fuel filter head.

6B-4. Connect the injector bleed line banjo fitting with 8mm banjo bolt and original sealing washers to the Return "T" Push Lock Coupler (Figure 26). The Return T Coupler is made from 2 of the 4A-1-18-05-04 and one of the 001-4A-1-0008 (Figure 25).

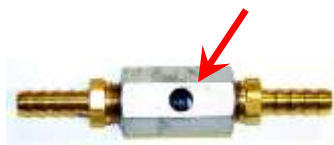

Figure 25



Figure 26



Figure 27

6B-5. Connect the P-7100 pump metal return line to the return "T" push lock coupler fitting with the flex fuel line P/N 4C-1-02-05-001 (Figure 27).

P-7100 Injector Pump and Injector Bleed Line Return to Tank, Continued

- 6B-6. Cut the original fuel return line to length and connect it to the other end of the Return "T" Push Lock Coupler fitting.



Figure 28

NOTE: The mechanical fuel lift pump must be disabled by removing the plunger.

- 6B-7. Remove the mechanical lift pump by removing the two bolts on each side of the pump. Remove the plunger. **Be very careful. DO NOT drop the plunger into the oil pan.**



Figure 29



Block Off Plate
(Not Included In Kit)
Figure 30



Figure 31

- 6B-8. Either re-install the pump on the engine without the plunger or cover the mechanical pump port on the engine with a Big Block Chevy pump "block off" plate from your local auto parts store (Figure 30).

AirDog® II Fuel Return Line Installing the Filler Neck Tee in the Filler Tube

- 6C-1. Cut filler tube as illustrated in figure 32, removing ½ inch of hose. Loose assemble clamps on each end of filler tube before the filler tube is pushed in.
- 6C-2. Insert the “Return Fuel Filler Tube” assembly (P/N 001-4A-1-0175) in the filler tube. **INSTALL THE FILLER TUBE WITH ARROWS, WHICH ARE STAMPED IN THE PART, POINTING TOWARD THE TANK!! SEE FIG 33.** Properly tighten clamps.

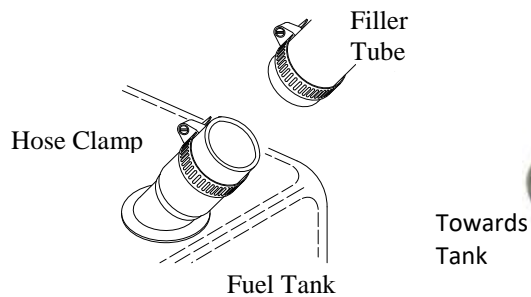

Figure 32



Figure 33



Figure 34

- 6C-3. Assemble one end of the hose (Reference section 5) using Fuel line end FQC3890 and plug it into the “Return” J2044 fitting installed in the AirDog® (Figure 35). A “click” will be heard once the fitting is properly connected.

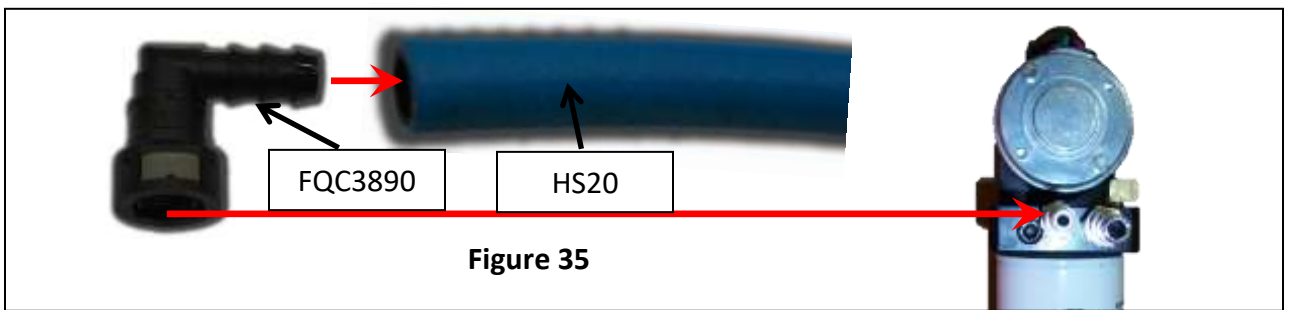

Figure 35

- 6C-4. Run the fuel line along the frame as mentioned in step 5-3 to the filler neck tee. Cut the fuel line to length and insert fuel line end FQC12S per step 5-1. Once the connector is installed, connect it to the male J2044 fitting in the filler neck tee (001-4A-1-0175). A “click” will be heard once properly connected.

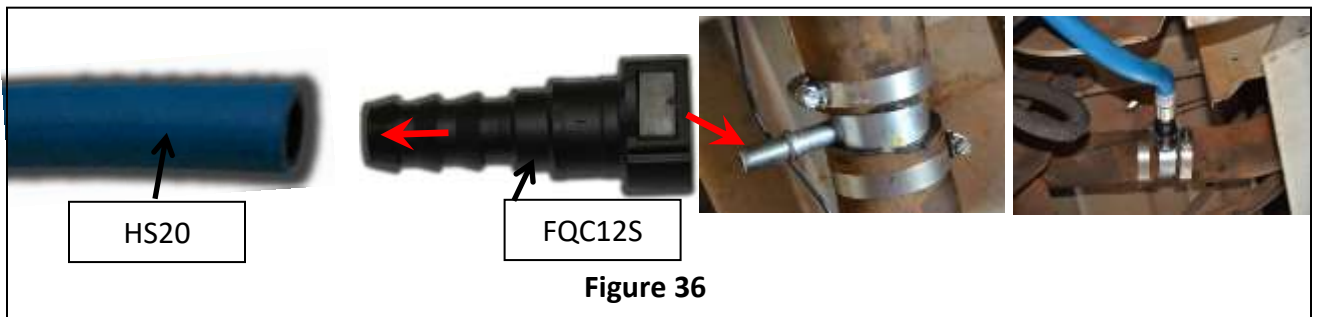

Figure 36

Fuel Suction Line for AirDog® II DF-200

- 6D-1. Assemble one end of the suction fuel line (reference section 5) using fuel line end FQC12S. Once the end is pressed in, connect it to the J2044 fitting in the “Fuel In” port on the AirDog®. A “click” will be heard when the fitting is properly connected.



Figure 37

HIGH FLOW SUCTION TUBE

- 6D-2. Either remove the bed or drop the tank for access to the collection basket.

The AirDog® II-200 includes a ½" High Flow suction tube (P/N WAP108) to accommodate the high flows of this system. To install the ½ suction tube, it is necessary to either drop the fuel tank or to lift the truck bed.

NOTE: Should you choose to drop the fuel tank, support the tank as it is when it is installed on the truck. If you let it rest flat on the floor, the tank may squash out and the suction tube will be too short after the tank is re-installed in the truck. The suction tube, being cut too short may suck air as the fuel drops below ¼ tank level.

NOTE: Should you choose to pull the pickup bed to access the tank. Be sure to disconnect the tail light wires, fuel tank filler tube, and any other accessories or components that may be secured to the frame and bed.

When Dropping the Tank, Always Remember, Safety First!



Figure 38



Figure 39



Figure 40

If you choose to remove the bed, properly support the truck bed to prevent serious injury or death!



Figure 41



Figure 42

NOTE: The fuel tank and truck bed used for the pictures are examples only and may not be exactly the same as your tank.

6D-3. Once either the tank has been dropped or the bed removed, remove the collection basket as shown in figures 43 and 44.



Figure 43



Figure 44

6D-4. Drill a 1-1/8" hole at the selected location (Figure 45) in the fuel tank for the suction tube. Hold a container below the drill point to catch debris as shown in figure 46.



Figure 45



Figure 46

6D-5. Remove all burrs from the edge of the hole as shown in figure 47.



Figure 47

6D-6. Install the grommet (P/N 5J-1-1-04-0001) in the new suction tube access hole as seen in figure 48.



Figure 48

6D-7. Measure and cut the suction tube to a length that will allow approximately 1/8" clearance off the bottom of the tank. It is suggested to form the end of the tube similar to Figure 49.



Figure 49

6D-8. Lubricate the bulkhead fitting on part WAP108 with motor oil. Pressing firmly, insert the suction tube assembly (WAP108) into the grommet. Be sure the bulkhead fitting is completely seated in the grommet.

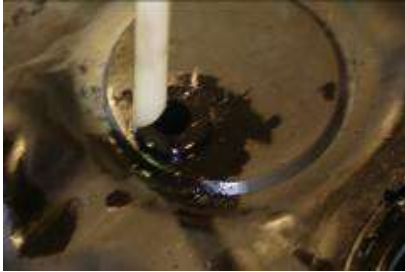

Figure 50



Figure 51

6D-9. Re-install the Collection basket. Re-install the factory return line to the proper port of the Collection basket before the tank is fully re-installed.



Figure 52

6D-10. Run the fuel line along the frame as mentioned in step 5-3 to Suction Tube (WAP108). Cut the fuel line to length and insert fuel line end FQC12S per step 5-1. Once the fuel line end is pressed in, connect it to the male J2044 fitting on WAP108. A “click” will be heard once properly connected.

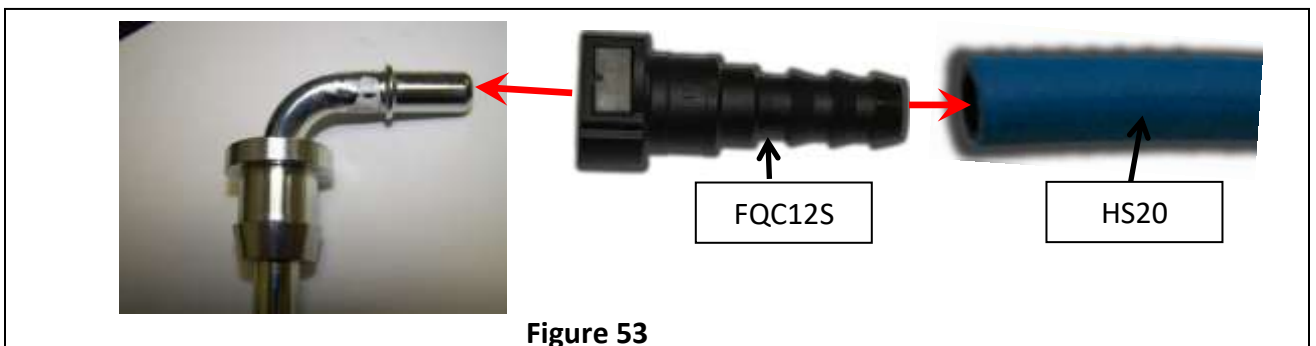

Figure 53

6D-11. If the fuel tank was dropped to install the suction tube, re-install the fuel tank. If the truck bed was removed, reinstall the bed.

AirDog® Wiring Harness Install

WIRING DIAGRAM

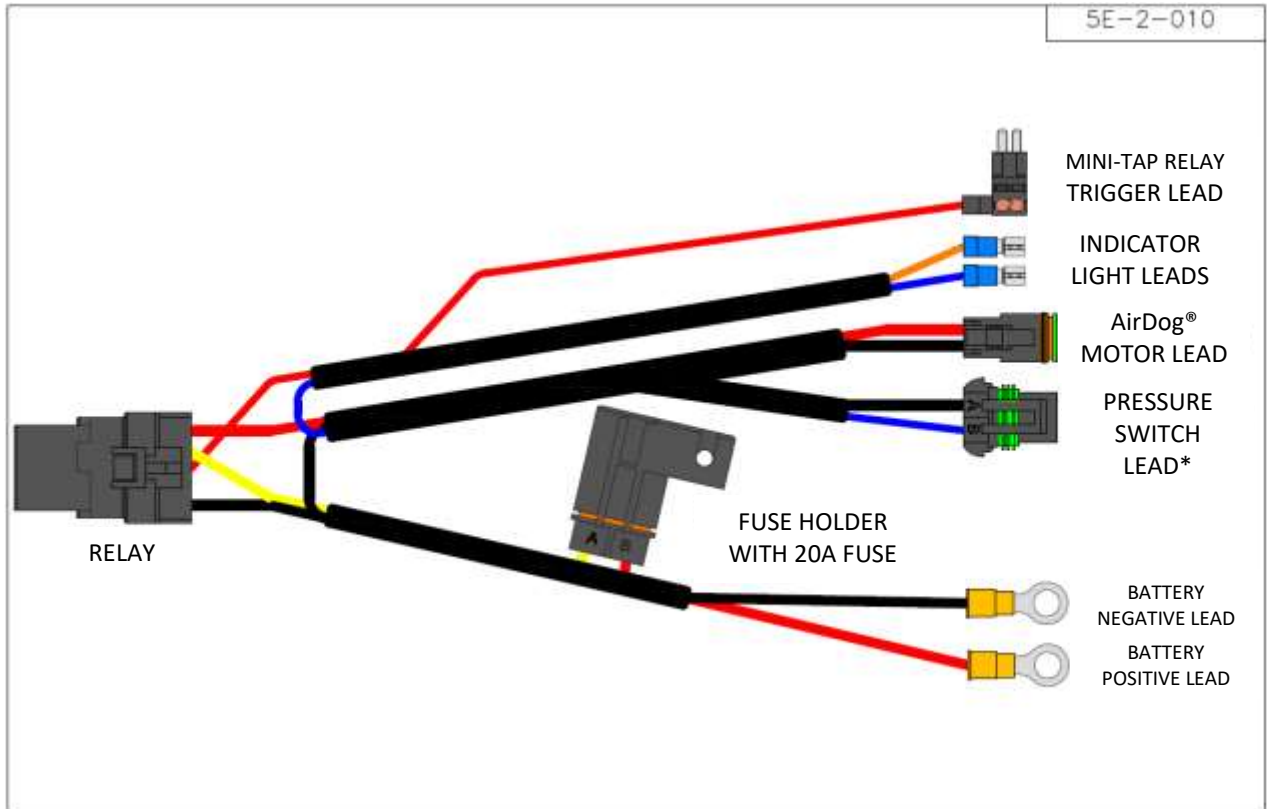

Figure 54

CAUTION: If the **OPTIONAL** Low Pressure Indicator Light is not used, be sure to insulate the two (2) #10 Indicator Light connectors and pressure sensor lead to prevent accidental contact.

***The light kit is sold separately and is not included in this kit.**

Secure the Relay and Fuse Holder to the Vehicle

- 7-1. Secure the relay and fuse holder to the vehicle. Be sure to route the wires away from any moving parts. The relay is illustrated below in figure 55. The fuse holder mounting is the same concept.



Figure 55

Connecting the AirDog® Relay Control to the Fuse Panel

- 7-2. Route the red relay trigger wire, with the mini fuse tap attached, to the fuse panel. Connect it to a terminal that is hot when key on. Install the fuse that was removed to install the fuse tap into the open slot in the fuse tap before it is installed.

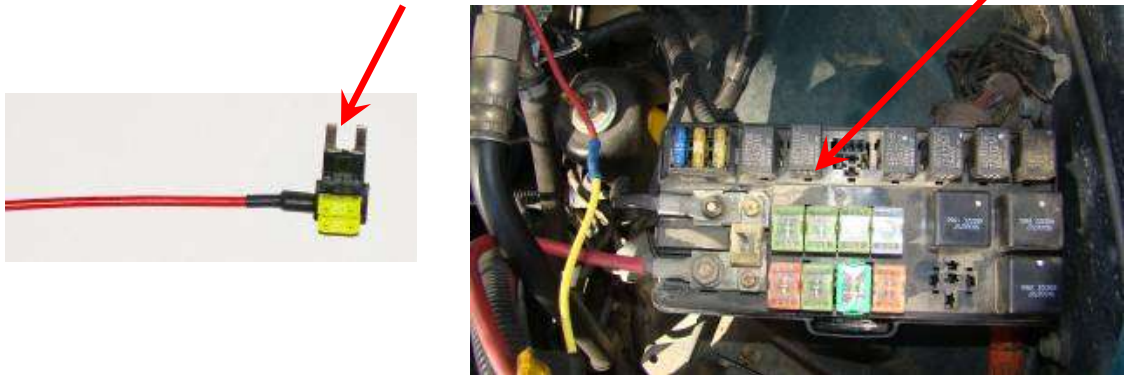

Figure 56

Connecting the Power Supply Leads to the Alternator or Battery

Note: Connecting the power supply leads to the alternator instead of the battery will create a corrosion resistant connection.

- 7-3A. Route the Red and Black power supply leads to the alternator. Connect the Black (-) lead to the alternator Chassis Ground connection. Connect the Red (+) lead to the alternator Hot Lead going to the battery.

Black (-)

Red (+)

Replace the Protective Cover



Figure 57



Figure 58

Connecting the power supply leads Continued

- 7-3B. Should you choose to connect the power supply leads directly to the battery, connect the Red (+) led to the Positive (+) post of the driver's side battery. Connect the Black (-) lead to the Negative (-) post of the same battery.

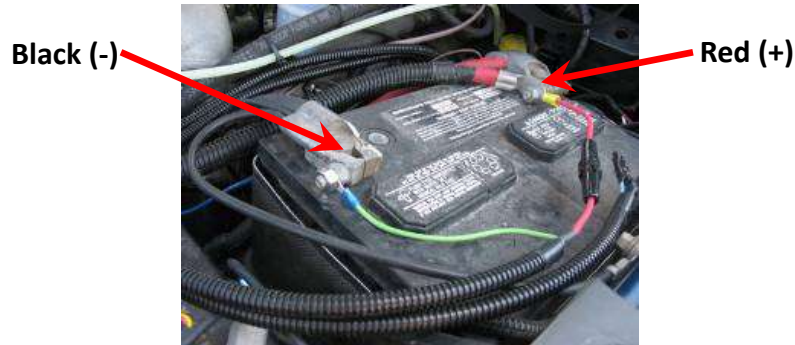

Figure 59

- 7-4. Route the wiring harness to the AirDog® and connect the 2 pin Deutsch connector to the corresponding connector on the AirDog®.



Figure 60

NOTE: If the Optional Indicator Light is not used, secure the pressure switch lead to the wiring harness with a plastic tie. Also, cover the pressure sensor lead to protect it, you may want to use it later.

INITIAL START PROCEDURE

- 8-1. The **AirDog®** II is a self-priming system, however, to prevent possible damage to the system, it is recommended to fill the water separator with diesel fuel before initial startup.
- 8-2. Rub diesel fuel or oil on the filter seals before installing to ensure a proper seal.
- 8-3. Turn the starter key to the on/run position.
- 8-4. While the **AirDog®** II is operating, bleed the fuel line to the engine of air by loosening the fuel line connection at the engine fitting. As soon as the line is purged of air and pure fuel is observed, properly tighten the fuel fitting. **NOTE: put a rag or shop towel over and around fitting to prevent splatter. Catch all spilled fuel and dispose of properly. Wear safety glasses.**
- 8-5. Start engine.

RECHECK ALL FUEL FITTINGS FOR LEAKAGE AND PROPERLY TORQUE. BE SURE ALL FUEL LINES ARE PROPERLY ROUTED TO PROTECT FROM EXCESSIVE HEAT AND SECURED TO PROTECT FROM CHAFFING AND ABRASION. RECHECK ALL ELECTRICAL LINES, SECURE AS NECESSARY.

CHECKING FOR EXCESSIVE PUMP NOISE

NOTE: Each AirDog® II has been manufactured in a Quality Controlled process and wet tested for operation and performance before shipment. This is a smooth running system. With fuel or air alone, the AirDog® II fuel pump will run quietly. However, if any fuel fitting on the vacuum side, between the fuel tank and the AirDog® II or the pre-filter has been left loose during the installation process, the system may be sucking air at an excessive rate and will be very noisy. Excessive restriction in the suction line from the fuel tank can cause vapor and noise, as well. To check for these problems, unscrew the pre-filter 3 or 4 full turns and activate the AirDog® II by turning the ignition switch to on. If the AirDog® II runs quietly, then excessive air from a loose fitting or leaking pre-filter seal or vapor from fuel flow restriction is most likely the reason for the excessive noise. Correct as necessary.

- A. The seal groove in the 3" filter is a snug fit and on occasion the seal has been found to not be fully seated. Remove the pre-filter, remove the seal from the top of the nut plate. Clean and lubricate the seal groove. Carefully replace the seal in the groove. Be sure to fully seat the seal.
- B. Check all fittings, especially the quick connect at the tank.

FILTER SERVICE RECOMMENDATIONS

Plugging of either the fuel filter or the water separator itself will cause low fuel pressure and low flow to the engine. If a low fuel pressure issue exists, replace the fuel filter. Typical fuel filter life is 15-20k miles depending on fuel quality.



The Water Separator

Replace the water separator every other time you change the Fuel Filter or if it becomes damaged or plugged. It is suggested to check/drain the water separator every three months or as needed should you experience excessive 'water in fuel' conditions. When installing the water separator, be sure to clean the underside of the AirDog® base. Follow the instructions printed on the pre-filter for proper tightening procedures.

CAUTION: Be extremely careful to prevent any contaminants or debris from entering the pre-filter when removing it for cleaning! Large debris will jam the Gerotor and cause the fuse to blow. This is not a warranty item. Should this happen, you can easily put the system back into working order. See the instructions on "How to clean the Gerotor" for proper procedures.

The Fuel Filter

Remove the fuel filter by turning it counter clockwise. **DO NOT** pre-fill the fuel filter with fuel. The AirDog® will fill the filter and prime the system automatically. Follow the instructions on the filter for proper tightening procedures.

CAUTION: Dispose of waste fuel and used filters properly

CLEANING DEBRIS/CHECKING FOR DAMAGE IN/TO THE GEROTOR ASSEMBLY

STEP 1: Remove the four (4) socket head cap screws that secure the Gerotor cap using a 3/16 allen wrench.



STEP 2: Carefully remove the O-rings you will need to reuse them.



STEP 3: Remove and clean the Gerotor. Be very careful to not damage the Gerotor.

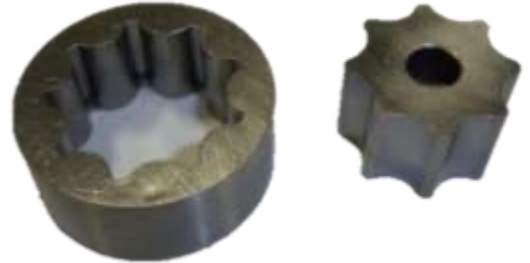

STEP 4: Remove the O-rings and clean/inspect the inside of the Gerotor pocket.



STEP 5: Reinstall the center gear.



STEP 6: Align and install the outer gear and O-rings.



STEP 7: Install the Gerotor Cap. Be very careful not to dislodge or pinch the O-rings.



STEP 8: Loose assemble the cap screws. Torque the cap screws in an opposing pattern.

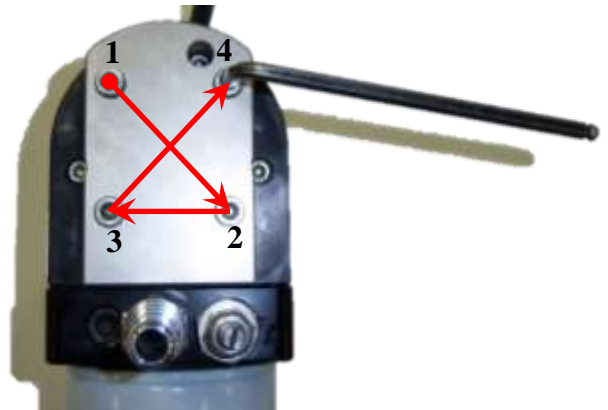

If there is damaged found to either the Gerotor, Gerotor pocket, or O-rings, call into AirDog® Tech Support for further assistance.

AirDog®II AND AirDog®II-4G ADJUSTABLE FUEL PRESSURE REGULATOR

The AirDog®II and AirDog®II-4G rises to a new level of performance with an adjustable fuel pressure regulator machined from stainless steel with a double O-ring seal system and a soft seat piston.

PRESSURE ADJUSTMENT FOR THE DODGE CUMMINS 12V P-Pump

Loosen the Jam Nut with a 9/16 wrench
Re-torque after adjustment

Use a flathead screwdriver to adjust the
pressure regulator



Turn the adjuster screw counter-clockwise to reduce the output pressure or clockwise to increase the pressure. Be sure to re-torque the jam nut after adjusting the regulator. **IT IS STRONGLY RECOMMENDED TO ADJUST THE PRESSURE WHILE USING A FUEL PRESSURE GAUGE. TOO MUCH OR TOO LITTLE PRESSURE MAY CAUSE DAMAGE TO THE INJECTION SYSTEM!**

INSPECTING THE REGULATOR SEALS AND CHANGING THE REGULATOR SPRINGS



Step 1. Remove the regulator by turning the Adjustment Screw counter-clockwise using a 3/4 wrench.

Step 2. After removing the regulator assembly, remove the springs and conical plunger. Inspect the O-rings on the Valve Adjuster and Regulator plunger for any nicks or tears. Replace any damaged O-rings at this time. **New O-rings are included in the Customer Service O-ring Kit (901-05-0100) if replacements are required.**

Step 3. Re-install the Regulator Plunger and Regulator Springs the same order in which they were removed.

Step 4. Tighten the Adjustment Screw to proper torque. Use a pressure sensor to set the desired pressure per above.

PARTS OF AN AirDog®II

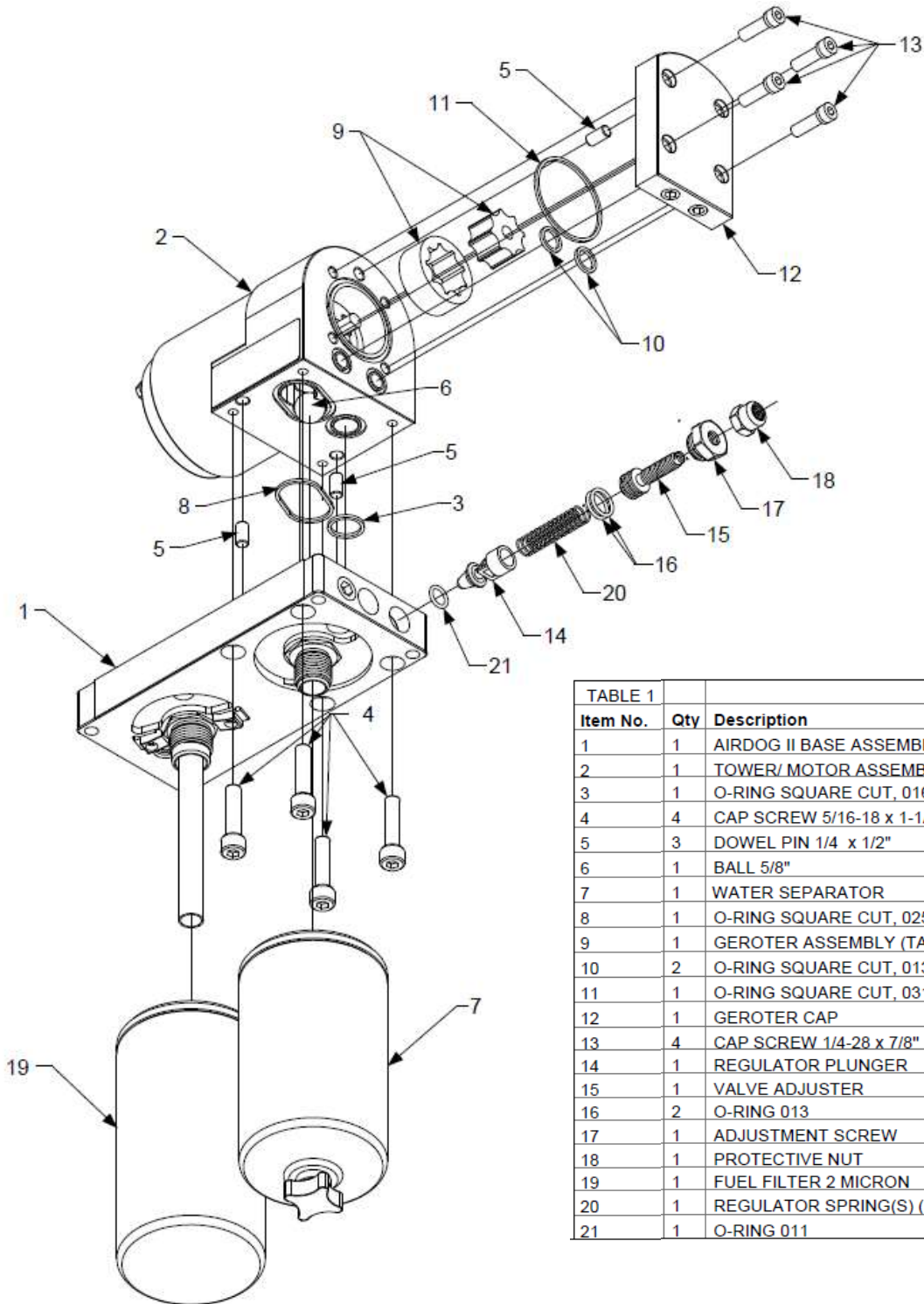

TABLE 1		
Item No.	Qty	Description
1	1	AIRDOG II BASE ASSEMBLY
2	1	TOWER/MOTOR ASSEMBLY
3	1	O-RING SQUARE CUT, 016
4	4	CAP SCREW 5/16-18 x 1-1/4"
5	3	DOWEL PIN 1/4 x 1/2"
6	1	BALL 5/8"
7	1	WATER SEPARATOR
8	1	O-RING SQUARE CUT, 025
9	1	GEROTER ASSEMBLY (TABLE 2)
10	2	O-RING SQUARE CUT, 013
11	1	O-RING SQUARE CUT, 031
12	1	GEROTER CAP
13	4	CAP SCREW 1/4-28 x 7/8"
14	1	REGULATOR PLUNGER
15	1	VALVE ADJUSTER
16	2	O-RING 013
17	1	ADJUSTMENT SCREW
18	1	PROTECTIVE NUT
19	1	FUEL FILTER 2 MICRON
20	1	REGULATOR SPRING(S) (TABLE 2)
21	1	O-RING 011

Installing a New Filter

1. Clean the area around the filter head and groove or seal area.

NOTE: Lubricate the seal with oil. Do not use diesel fuel to lubricate the seal.

2. Install a new fuel filter on the filter head. Turn clock-wise until the filter contacts the seal. Tighten the filter one full turn or follow tightening instructions on filter after contact with the seal has been made.

NOTE: It is not necessary to pre-fill the fuel filter!

CAUTION: DO NOT OVER TIGHTEN, OVER TIGHTENING CAN DISTORT THREADS OR DAMAGE THE FILTER SEAL.

3. **To prime the filter,** turn the ignition switch to the on position. Start the engine.

Water Separator

With the engine turned off, pinch off the suction line. Open valve on the bottom of the water separator. Drain into a suitable container until all water has been removed. Close valve. Remove the pinch in the suction.

DRAINING: The water separator should be serviced once a month or when severe water in fuel conditions require.

NOTE: Collect all spilled fuel and dispose of in accordance with federal, state and local regulations.

PUREFLOW AIRDOG
LIFETIME LIMITED EXPRESS WARRANTY

FOR

Covered PureFlow AirDog I, II and Raptor Systems

IMPORTANT NOTICE

TO ACTIVATE YOUR PUREFLOW AIRDOG WARRANTY, YOU MUST COMPLETE AND MAIL YOUR WARRANTY CARD TO PUREFLOW AIRDOG WITH A COPY OF YOUR ORIGINAL SALES RECEIPT WITHIN 30 DAYS OF PURCHASE. FAILURE TO COMPLETE AND SUBMIT YOUR WARRANTY CARD WILL RESULT IN A WARRANTY PERIOD OF THE COVERED PRODUCT TO ONE (1) YEAR FROM THE DATE OF PURCHASE.

PureFlow AirDog (hereafter collectively, "SELLER") warrants and guarantees only to the Original Purchaser (hereafter collectively, BUYER) that the PureFlow AirDog systems FP-100, FP-150, Raptor Fuel Pump RP-100 or RP-150 (hereafter collectively, PRODUCT) shall be free from defects of materials and workmanship in the manufacturing process for as long as the BUYER owns the PRODUCT.

The Lifetime Limited Express Warranty is limited to the PRODUCT purchased by the original BUYER of the PRODUCT and limited solely to the parts contained within the PRODUCT and EXCLUDES ALL ELSE INCLUDING FILTERS AND WATER SEPARATORS. Any PRODUCT that is in question of Warranty must be returned, shipped prepaid, to PureFlow AirDog. All Warranty claims are subject to the approval of PureFlow AirDog. If it is determined that a Warranty claim exists, PureFlow AirDog will, at its sole discretion, replace the defective PRODUCT with a comparable PRODUCT, repair the defective PRODUCT, or refund the BUYER'S purchase price in exchange for the PRODUCT. Repairs or replacements are warranted for only the remainder of the original warranty period and only to the original BUYER.

Under no circumstances shall the SELLER be liable for any labor charged or travel time incurred in the diagnosis for defects, removal, or reinstallation of the PRODUCT, or any contingent expense.

Under no circumstances will the SELLER be liable for any damage or expense incurred by reason of the use or sale of the PRODUCT.

Other than expressly set forth herein, the SELLER shall in no way be responsible for the proper or improper use and service of the PRODUCT. In no event shall the SELLER be liable for any special, incidental, indirect or consequential damages of any kind or nature, whether or not the BUYER of the PRODUCT was advised of the possibility of damage or harm, arising or resulting from the use or performance of the PRODUCT and BUYER hereby waives the right to any and all such claims.

BUYER, acknowledges that he/she is not relying on SELLER'S skill or judgment to select or furnish goods suitable for any particular purpose and that SELLER has no liability that will extend beyond the scope of the LIMITED EXPRESS WARRANTY contained herein, and BUYER hereby waives all remedies or liabilities, expressed or implied, arising by operation of law or otherwise, (including, without limitation, any obligation of SELLER with respect to fitness for any particular purpose; merchantability; and special, incidental, indirect or consequential damages) or whether or not occasioned by SELLER'S negligence.

SELLER disclaims any warranty and expressly disclaims any liability for personal injury or damages related to BUYER'S use of the PRODUCT. BUYER acknowledges and agrees that the disclaimer of any liability for personal injury is a material term for this agreement and BUYER agrees to indemnify SELLER and hold SELLER harmless from any claim related to the PRODUCT and its use or performance. Under no circumstances will SELLER be liable for any damages, liabilities, costs or expenses incurred as a result of or by reason of use, performance or sale of the PRODUCT, including without limitation, any damages, liabilities, costs or expenses incurred by reason of BUYER'S negligence related to those uses of the PRODUCT.

The proper installation of the PRODUCT is the sole responsibility of the BUYER. The SELLER assumes no liability regarding improper installation or misapplication of the PRODUCT.

SELLER hereby provides the following limited warranty as to description, quality, merchantability, fitness for the PRODUCT'S purpose, productiveness, or any other matter of SELLER'S PRODUCT sold herewith. The SELLER shall be in no way responsible for the open use and service of the PRODUCT and the BUYER hereby waives all rights other than

those expressly written herein. This Warranty shall not be extended or varied except by a written instrument signed by SELLER and BUYER.

IN THE EVENT THAT THE BUYER DOES NOT AGREE WITH THIS AGREEMENT, THE BUYER MAY PROMPTLY RETURN THE PRODUCT, IN A NEW AND UNUSED CONDITION, WITH A DATED PROOF OF PURCHASE, TO THE PLACE OF PURCHASE WITHIN THIRTY (30) DAYS FROM THE DATE OF PURCHASE FOR A FULL REFUND. THE BUYER AGREES THAT THE INSTALLATION OF THIS PRODUCT CONFIRMS THE BUYER HAS READ AND UNDERSTANDS THIS AGREEMENT AND ACCEPTS THE TERMS AND CONDITIONS OF THIS AGREEMENT.

Warranty Procedure

In the unlikely event a warranty appears as if it may be warranted, the following steps are taken:

- 1 The customer discussed the symptoms of the problem with a PureFlow AirDog Technician. The customer is to have the system Serial Number and Model Number available for the Technician when the call is made. This will expedite all steps of the process.
- 2 The customer performs any and all tests requested by the PureFlow AirDog Technician. This is done to isolate the potential problem while eliminating potential installation or maintenance related issues,
- 3 If the PureFlow AirDog Technician determines based on the customer feedback concerning the requested testing that system may be at fault, the customer is advised that all returned pumps are tested upon arrival and should this returned pump perform at design criteria upon arrival, the customer will be charged a \$50.00 fee.
- 4 The PureFlow AirDog Technician will first request the customer's phone number in the event the phone call is accidentally disconnected and then transfer the customer to a PureFlow AirDog Customer Service Representative. Should a Customer Service Representative not be available, the Technician will offer the Customer the option to hold, call back, or receive a return call.
- 5 The PureFlow AirDog Customer Service Representative will check to determine if the customer's Warranty Registration Card is on file.
 - a. If no Warranty Registration is found, the customer will be required to supply the original purchase receipt showing the purchase date.
 - b. If no Warranty Registration is found, the customer will be advised of the options should the system in question is out of the default warranty period (1 year).
- 6 The PureFlow AirDog Customer Service Representative will request the customer information, including: Name, Address, Phone Number, Model Number, Serial Number, Year / Make / Model of vehicle, Name of Dealer purchased from, Purchase Date, Description of Problem, Customers' understanding of the resolution, and customer credit card information.
- 7 PureFlow AirDog will cover Ground Shipping charges to ship the replacement unit and will include a prepaid shipping label for the return of the defective unit. Any additional items ordered at the time of the replacement shipment will include their portion of the shipping cost.
- 8 A period of 15 Calendar Days from the time of shipment is provided for the receipt of the defective unit at the PureFlow AirDog facility. Failure to return ship the defective unit to arrive within the defined time period will result in a charge of \$250.00 against the customer's credit card as the purchase cost of the defective unit.