

#4

AirDog

FUEL PREPARATOR

FP-100 & FP-150

INSTALLATION MANUAL

FOR 24V CUMMINS POWERED

DODGE TRUCKS

2005 AND UP

**HIGH PERFORMANCE FUEL SYSTEM
WITH QUICK CONNECT COMPONENTS**

**PLEASE READ THESE INSTRUCTIONS THOROUGHLY
BEFORE BEGINNING THE INSTALLATION**



**PUREFLOW AIRDOG
705 W MAUSOLEUM RD.
SHELBYVILLE, IN 46176**

**877-421-3187
PUREFLOWAIRDOG.COM**

CANADIAN PATENT
2,108,391

PROTECTED BY
US PATENTS
5,355,860; 5,746,184; 6,729,310

AUSTRALIAN PATENT
2005101054

NEW ZEALAND PATENT
532356

Additional Foreign Patents Pending in Europe, South America, Mexico, Japan, and China!

AirDog® FUEL PREPARATOR®



SMALL and COMPACT
7" Long X 3.2" Wide X 10" Tall

OVERVIEW

Welcome to PureFlow® AirDog® Fuel Air Separation System for the Diesel Engine!

The AirDog® Fuel Air Separation system is a Premium replacement lift pump and filtration system for the Dodge Cummins 24 Valve 5.9L diesel engines with the CP3 and in-tank factory lift pump. A complete installation kit is included.

The AirDog® delivers clean fuel to the engine free of virtually all air/vapor and at a positive flow. Thus, allowing the engine “test cell” performance and efficiency, while in “real world” use.

The AirDog® FP-100 is recommended for stock and slightly modified 5.9L and 6.7L Cummins Diesels.

The AirDog® FP-150 is recommended for highly modified 5.9L and 6.7L Cummins Diesels.

PureFlow® products are manufactured with a personal touch,
unsurpassed attention to detail

And

The most stringent quality control!

TYPICAL INSTALLATION LAYOUT

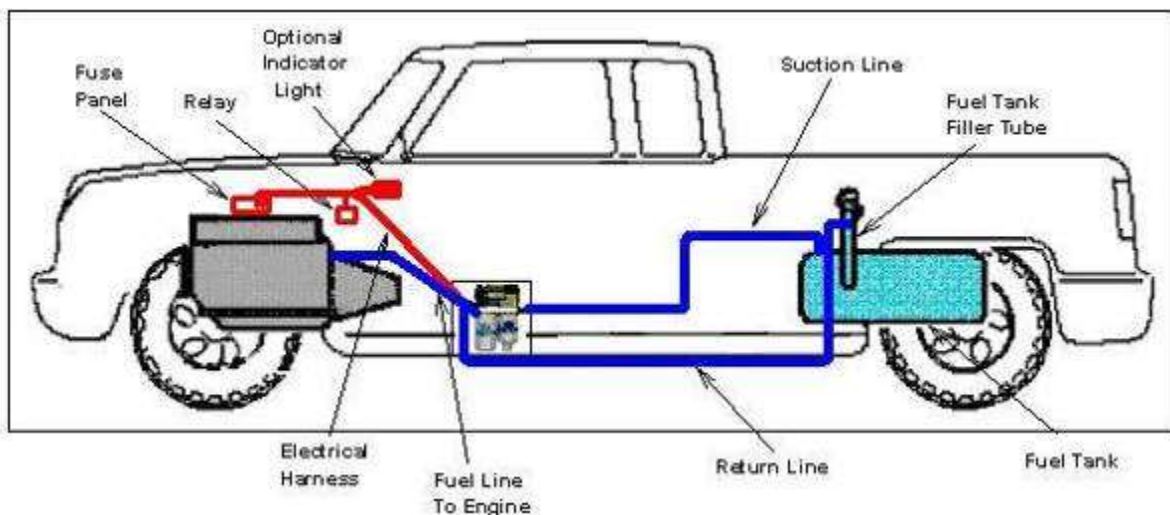

Figure 1

The AirDog® draws fuel from the fuel tank at constant flow, removing water, particulates, entrained air and vapor. A regulated pressurized flow is maintained to meet the engine’s varying fuel demands. The separated air/vapor is returned by the AirDog® to the fuel tank.

NOTE: The pictures used in this manual are for example only and may not be exactly the same as your truck.

QUICK CONNECT COMPONENT OVERVIEW

Provided in this kit is an OE style Quick Connect System. This system works to allow for a quick, clean, and professional install.

SAE J2044 Quick Connect System

The SAE J2044 quick connect system is the most commonly used system in the automotive industry. The images below show the formation of SAE J2044 connection. To connect the assemblies, simply insert the male end form into the mating female connector. Push firmly until you hear it “click” into place. To disconnect the fittings, press down and hold the tabs on the female connector while you firmly pull the assembly apart.



TABLE OF CONTENTS

Section 1.....Table of Contents

Section 2.....Installation and Safety Guidelines

Section 3.....Parts List

INSTALLATION PROCEDURES

Section 4.....Fittings, Brackets, and Mounting

FUEL LINES

Section 5.....Assembling the Fuel Lines

Section 6 A.....Supply Line to Engine 5.9L

Section 6 B.....Supply Line to Engine 6.7L

Section 6 C.....Fuel Return to Tank

FUEL SUCTION LINES

Section 6 D.....Suction Line from High Flow Suction Tube

ELECTRICAL HARNESS

Section 7.....Wiring Harness

Section 8.....Initial Start Procedure

MAINTENANCE & UPGRADES

Section 9.....Filter Service Recommendations

Section 10.....Pressure Regulator Changes

Section 11.....Cleaning the Gerotor Assembly

Section 12.....Lifetime Limited Express Warranty

AirDog®

MODEL FP-100 & FP-150

The installation of your **AirDog®** can be made relatively easy by following the steps outlined in this manual, and:

1. Inventory the package components completely. Notify *PUREFLOW® AIRDOG* immediately of any parts missing or damaged.
2. Read the installation manual completely. Understand how the system operates and installation recommendations before beginning installation.
3. The installation recommendations contained herein are suggested installation guidelines only. Individual installations may vary.
4. If any installation procedure is uncertain, contact *PUREFLOW® AIRDOG* for technical assistance.
5. **When installing the AirDog® fuel lines be sure to keep the ORIGINAL ENGINE RETURN LINE connected as it is from the factory!**

SAFETY GUIDELINES!

CAUTION! Please be sure to chock the vehicle's tires to prevent rolling.

CAUTION! Please use proper supports when working beneath an elevated vehicle.

CAUTION! Most diesel pickups have two (2) 12volt batteries. Disconnect the battery cables to both batteries before proceeding with the AirDog® installation.

CAUTION! Vehicle frame rails should not be drilled into or welded upon.

CAUTION! Wear safety glasses when operating power tools such as drills and grinders or when using a punch or chisel.

CAUTION! Use common sense when routing fuel lines and electrical harnesses. Keep them away from hot exhaust components and/or moving parts. Properly secure lines to prevent chaffing.

Use Good Judgment and Common Sense When Installing the AirDog® !

AirDog® Parts List

QTY	DESCRIPTION	Part Number	IMAGE
1	AirDog®	FP-100-D12 <i>Or</i> FP-150-D12	
1	AirDog® Mounting Bracket	001-3C-0004	
1	Mounting Bracket Hardware Kit, Includes:	901-61-0102-PM	
1	Frame Bracket Set	010-3C-0002 010-3C-0001	
1	Wiring Harness	5E-2-014	
1	Return Fuel Filler Tube (with 2 Clamps)	001-4A-1-0150	
1	Bundle of Plastic Ties	5H-2-1-06/12	
1	High Flow Suction Tube (For FP-150's Only)	WAP108	
1	Grommet (For FP-150's Only)	5J-1-1-04-0001	
1	Spacer	010-3C-0003-A-P	
1	20ft of Hose	HS20	
4	1/2" Straight Hose Quick Connect End	FQC12S	
2	1/2" 90° Hose Quick Connect End	FQC1290	
1	12mm X 1/2" male SAE J2044 Fitting	WAP102	
1	Seal Washer (Assembles on WAP 102)	1P-5-DS	
1	Customer Service Oring Replacement Kit	901-05-0101	
2	1/2" Male SAE J2004 Quick Connect x 3/4" UNF	08J2044-3/4UNF	
1	17PSI Spring	1V-1-00003	

ILLUSTRATION OF QUICK CONNECT COMPONENTS

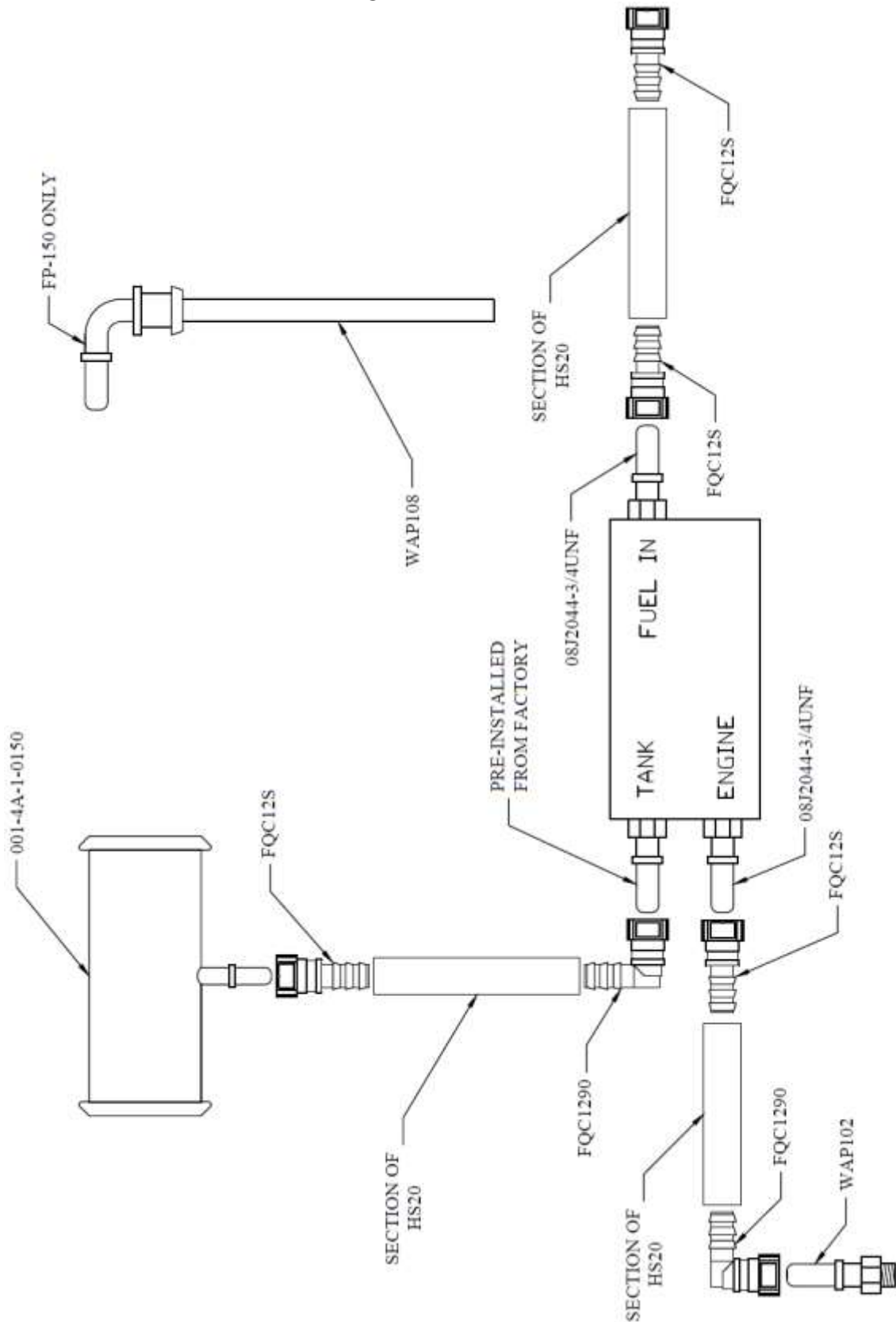

Installing the AirDog® Fittings & Mounting the Bracket on the Truck's Frame Rail

- 4-1. Dip the threaded end of the 1/2" male J2044 quick connect x 3/4" UNF fittings (08J2044-3/4UNF) into clean motor oil and hand-thread into the "ENGINE" and "FUEL IN" ports in the AirDog®. Using a 7/8" deep socket, torque these fittings to 180in-lb or 15ft-lb. **DO NOT overtighten the fittings or damage may occur!**



Figure 2

INSTALL THE AirDog® ON THE BRACKETS AND THE TRUCK'S FRAME

- 4-2. Assemble the AirDog mounting bracket (001-3C-0004) to the frame bracket (010-3C-0001) using the spacer (010-3C-0003-A-P) as shown in figure 3 using the four bolts, lock washers, and nuts included in the mounting bracket hardware kit (figure 4). Properly torque all fasteners! The bracket assembly should look like figure 5. You will need a 3/16" Allen and a 1/2" Wrench.



Figure 3



Figure 4



Figure 5

- 4-3. Attach the AirDog® to the frame bracket assembly as shown in figure 6 using the supplied hardware in the mounting bracket hardware kit (P/N 901-61-0102-PM). You will need a 3/16" Allen and a 7/16" wrench.



Figure 6

NOTE: We recommend installing the AirDog® on the inside of the frame rail, but we understand some applications just don't have the room. The photos in this manual may not be the same as your application.

- 4-4. Be sure to tuck the AirDog® as far up as possible without it rubbing on anything to prevent damage from road debris. The bracket assembly is adjustable to achieve this.
- 4-5. Clamp the frame between the AirDog® bracket assembly and the backing plate using the 3/8" x 3 1/2" bolts, lock washers, and nuts included in the kit. Use two 9/16" wrenches to tighten.

Inside of Frame



Figure 7



Figure 8

**Mount
The AirDog®
Outside
The
frame
OR
Inside
The
Frame**

Outside of Frame



Figure 9



Figure 10

- 4-6. Position the AirDog® on the frame as necessary for clearance. Properly torque the bolts & nuts!

NOTE: Be sure to mount the AirDog® so the 'FUEL IN' port is directed toward the rear of the vehicle(Figure 11).

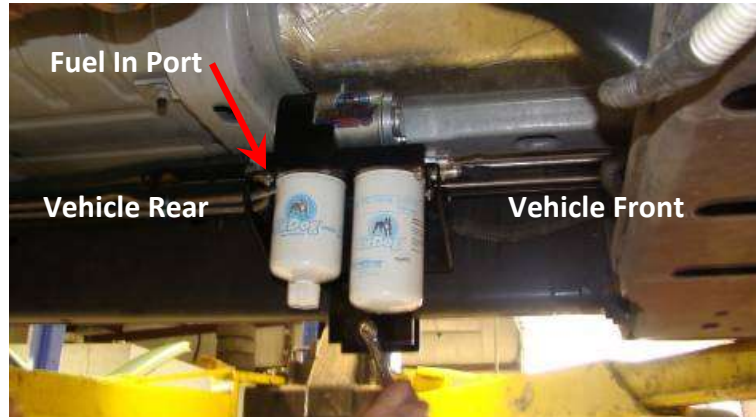

Figure 11

NOTE: Some pickup model frame rails have a bracket that is used to support the frame during the manufacturing process. If this bracket is on your frame rail and obstructs the proper positioning of the AirDog® mounting bracket, you may remove part or all of it, as needed (Figures 12 and 13). Be very careful not to damage the frame flange!



Figure 12



Figure 13

Assembling the Fuel Lines

This kit includes a length of fuel line and separate fuel line ends to allow for much cleaner looking installations! Assemble the fuel lines as you install them. You won't want to pre-assemble the hoses or your lengths may be off.

- 5-1. Take the fuel line end and lubricate the barbed end with clean motor oil (Figure 14) and press it into the fuel line (HS20) until all three barbs are covered (Figures 15 and 16). The fuel line end should look like Figure 16.



Figure 14



Figure 15



Figure 16

- 5-2. Now plug that fuel line with that fitting into the connection on the either the AirDog or the truck where the manual calls it out.
- 5-3. Run the fuel line along the frame away from any hot or moving parts such as exhaust or the driveshaft (Figure 17). Cut the hose to length and insert the other fuel line end that the manual calls out into the fuel line as outlined in step 5-1.



Figure 17

NOTE: Hose clamps are not needed for these push-lock connectors.

Installing the Fuel Supply Line from the AirDog® to the CP3 Injection Pump 5.9L

When installing the AirDog® fuel system, it is recommended to bypass the factory filter canister for optimum engine performance.

- 6A-1. Using a 17mm wrench, remove the “banjo bolt” (Highlighted in Figure 18) and the original factory fuel supply line at the fuel inlet port of the CP-3 high pressure pump.

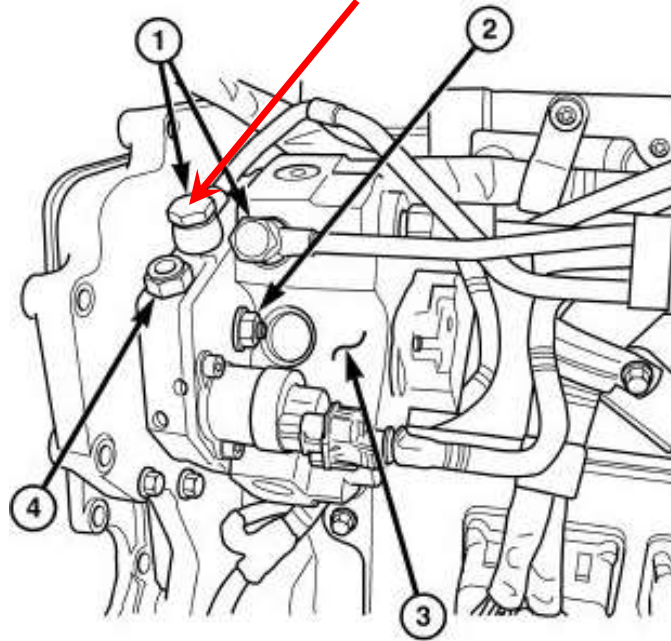

Figure 18

- 6A-2. Install the 12mm x 1/2" male SAE J2044 (WAP 102) fitting with the seal washer (1P-5-DS) supplied into the inlet port of the CP3 injection pump (Figure 19) once the original fitting is removed. **Do not over tighten the fitting. It may crack or break.** Either remove or bend the original supply line out of the way.

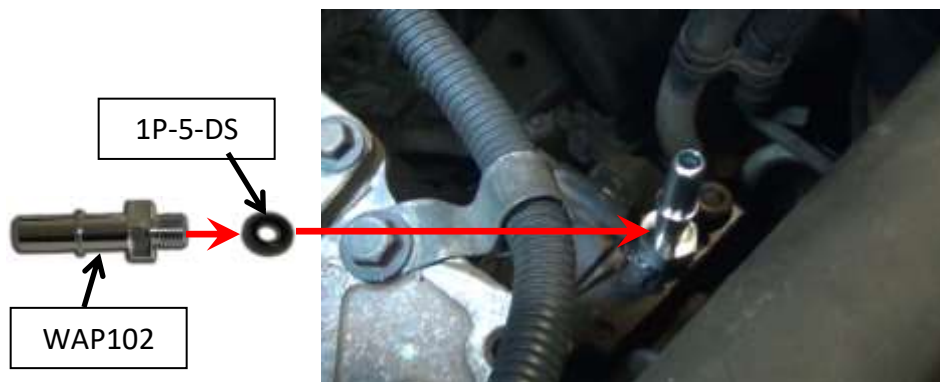
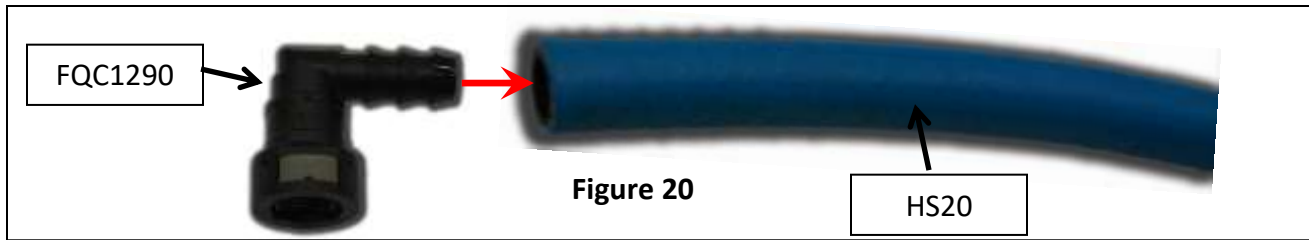
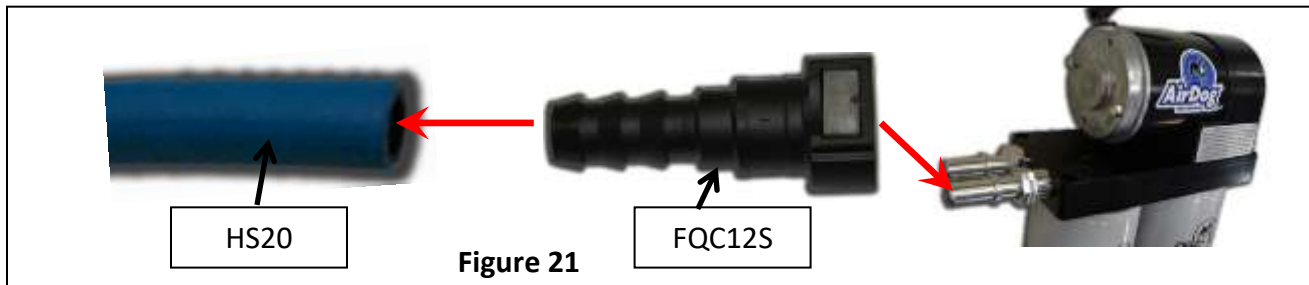

Figure 19

6A-3 Assemble one end of the hose (Reference section 5) using Fuel line end FQC1290 and plug it into the WAP102 fitting installed in the previous step. A “click” will be heard once the fitting is properly connected.



6A-4. Run the fuel line along the frame as mentioned in step 5-3 to the “Engine” port in the AirDog®. Cut the fuel line to length and insert fuel line end FQC12S per step 5-1. Once the connector is installed, connect it to the male J2044 fitting in the “Engine” port in the AirDog®. A “click” will be heard once properly connected.



6A-5. It is advised to remove the factory supply lines between the tank and the filter canister. Also remove the factory supply line between the filter canister and the injection pump. Then plug the ports on the filter canister. This will prevent fuel spillage.



Figure 22

NOTE: Be sure to keep the ORIGINAL ENGINE RETURN LINE connected as it is from the factory! In many cases the return runs thru the flange of the filter canister.

Installing the Fuel Supply Line from the AirDog® to the CP3 Injection Pump 6.7L

When installing the AirDog® fuel system, it is recommended to bypass the factory filter canister for optimum engine performance.

- 6B-1. Using a 17mm wrench, remove the “banjo bolt” (Highlighted “2” in Figure 23) and the original factory fuel supply line at the fuel inlet port of the CP-3 high pressure pump.

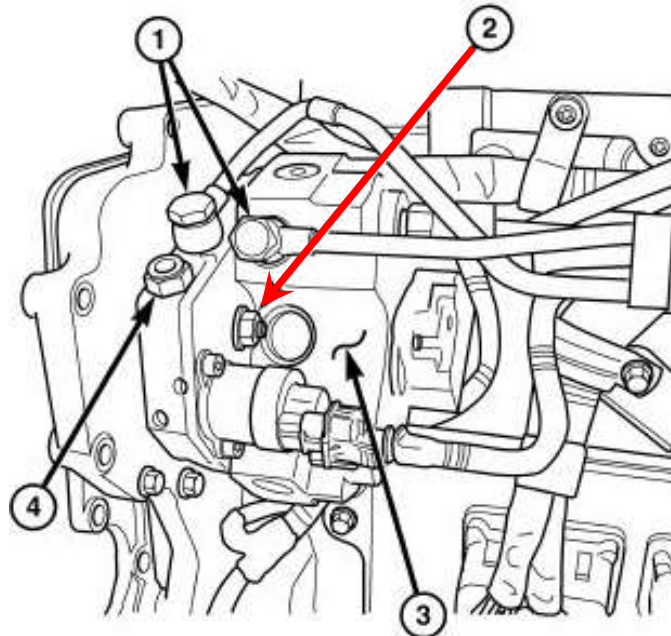

Figure 23

- 6B-2. Install the 12mm x 1/2” male SAE J2044 (WAP 102) fitting with the seal washer (1P-5-DS) supplied into the inlet port of the CP3 injection pump (Figure 24) once the original fitting is removed. **Do not over tighten the fitting. It may crack or break.** Either remove or bend the original supply line out of the way.



Figure 24

- 6B-3. Refer to steps 6A-3 and 6A-4 to install the fuel supply line for the 6.7L CP3.

AirDog® Fuel Return Line Installing the fuel 'Return to Tank' assembly in Filler Tube

- 6C-1. Cut filler tube as illustrated in figure 25, removing 1/2 inch of hose. Loose assemble the clamps on each end of filler tube before the filler tube is pushed in.
- 6C-2. Insert the "Return Fuel Filler Tube" assembly (P/N 001-4A-1-0150) in the filler tube.
INSTALL THE FILLER TUBE WITH ARROWS, WHICH ARE STAMPED IN THE PART, POINTING TOWARD THE TANK!! SEE FIG 26. Properly tighten clamps.

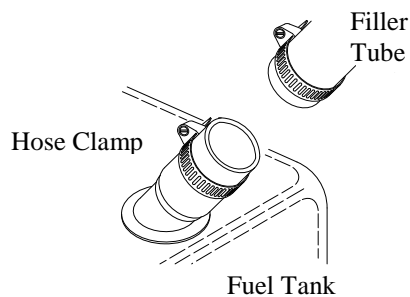

Figure 25



Figure 26



Figure 27

- 6C-3. Assemble one end of the hose (Reference section 5) using Fuel line end FQC1290 and plug it into the "Return" J2044 fitting installed in the AirDog® (Figure 28). A "click" will be heard once the fitting is properly connected.

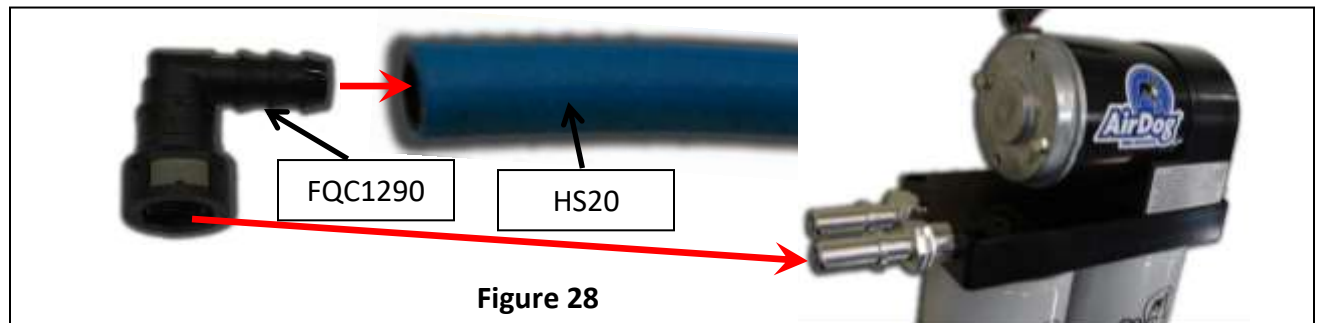

Figure 28

- 6C-4. Run the fuel line along the frame as mentioned in step 5-3 to the filler neck tee. Cut the fuel line to length and insert fuel line end FQC12S per step 5-1. Once the connector is installed, connect it to the male J2044 fitting in the filler neck tee (001-4A-1-0150). A "click" will be heard once properly connected.

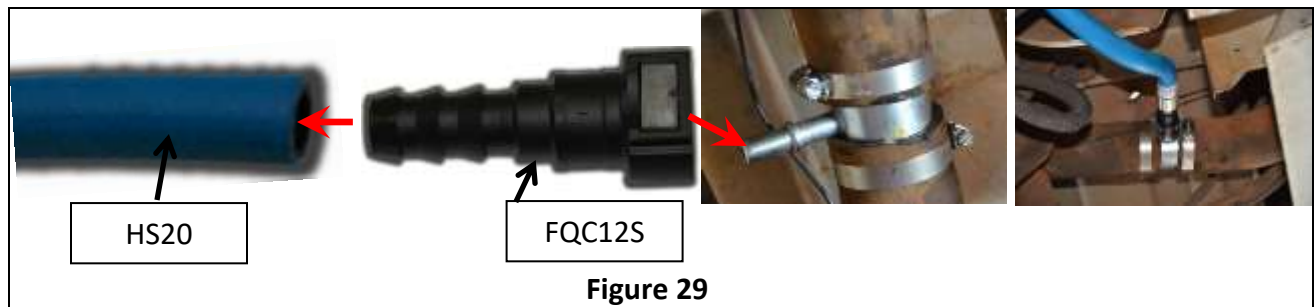

Figure 29

Fuel Suction Line for AirDog® FP-100 and FP-150

- 6D-1. Assemble one end of the suction fuel line (reference section 5) using fuel line end FQC12S. Once the end is pressed in, connect it to the J2044 fitting in the “Fuel In” port on the AirDog®. A “click” will be heard when the fitting is properly connected.



HIGH FLOW SUCTION TUBE

- 6D-2. Either remove the bed or drop the tank for access to the collection basket.

The AirDog® 150 includes a 1/2" *High Flow* suction tube (P/N WAP108) to accommodate the high flows of this system. To install the 1/2" suction tube, it is necessary to either drop the fuel tank or to lift the truck bed.

NOTE: Should you choose to drop the fuel tank, support the tank as it is when it is installed on the truck. If you let it rest flat on the floor, the tank may squash out and the suction tube will be too short after the tank is re-installed in the truck. The suction tube, being cut too short may suck air as the fuel drops below 1/4 tank level.

NOTE: Should you choose to pull the pickup bed to access the tank. Be sure to disconnect the tail light wires, fuel tank filler tube, and any other accessories or components that may be secured to the frame and bed.

When Dropping the Tank, Always Remember, Safety First!



Figure 31



Figure 32



Figure 33

If you choose to remove the bed, properly support the truck bed to prevent serious injury or death!



Figure 34



Figure 35

NOTE: The fuel tank and truck bed used for the pictures are examples only and may not be exactly the same as your tank.

IMPORTANT: Select a location for the suction tube that has adequate clearance below the bed. Also consider that under hard acceleration, fuel will migrate toward the back of the fuel tank.

6D-3. Once either the tank has been dropped or the bed removed, remove the collection basket as shown in figures 36 and 37.



Figure 36



Figure 37

6D-4. Drill a 1-1/8" hole at the selected location (Figure 38) in the fuel tank for the suction tube. Hold a container below the drill point to catch debris as shown in figure 39.



Figure 38



Figure 39

6D-5. Remove all burrs from the edge of the hole as shown in figure 40.



Figure 40

6D-6. Install the grommet (P/N 5J-1-1-04-0001) in the new suction tube access hole as seen in figure 41.



Figure 41

6D-7. Measure and cut the suction tube to a length that will allow approximately 1/8" clearance off the bottom of the tank. It is suggested to form the end of the tube similar to Figure 42.



Figure 42

- 6D-8. Lubricate the bulkhead fitting on part WAP108 with clean motor oil. Pressing firmly, insert the suction tube assembly (WAP108) into the grommet (Figure 43). Be sure the bulkhead fitting is completely seated in the grommet.

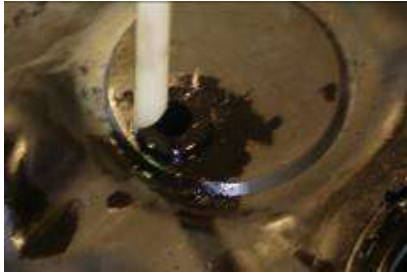

Figure 43



Figure 44

- 6D-9. Re-install the Collection basket. Re-install the factory return line to the proper port of the Collection basket before the tank is fully re-installed.



Figure 45

- 6D-10. Run the fuel line along the frame as mentioned in step 5-3 to Suction Tube (WAP108). Cut the fuel line to length and insert fuel line end FQC12S per step 5-1. Once the fuel line end is pressed in, connect it to the male J2044 fitting on WAP108. A “click” will be heard once properly connected.

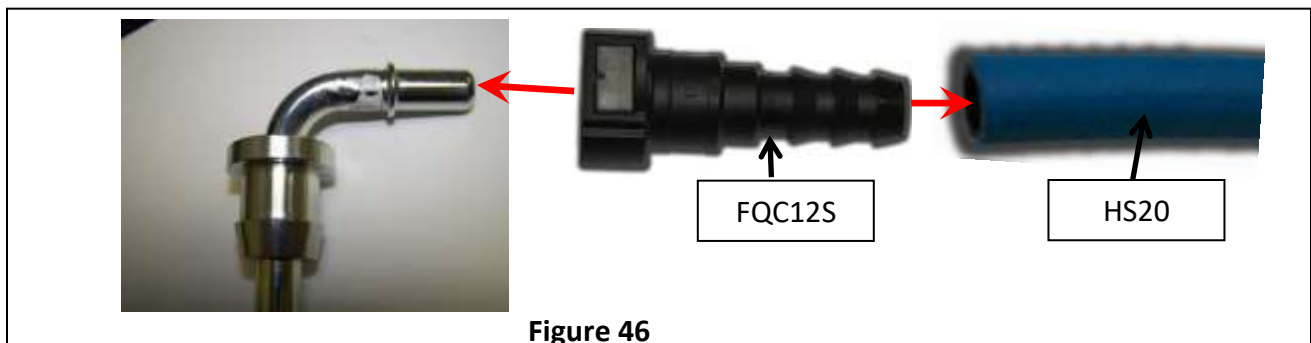

Figure 46

- 6D-11. If the fuel tank was dropped to install the suction tube, re-install the fuel tank. If the truck bed was removed, reinstall the bed.

Connecting the AirDog® Power Lead Jumpers

- 7-2. Remove the factory wire harness connection from the top of the fuel module as seen in (Figure 49)



Figure 49

- 7-3. Plug the AirDog® female power lead jumper into the top of the fuel module.
7-4. After a “click” is heard, slide the red locking clip over to lock the connection in place.
7-5. Plug the factory wire harness connector into the AirDog male power lead jumper. Again, listen for the “click”.

Connecting the Power Supply Leads to the Alternator or Battery

Note: Connecting the power supply leads to the alternator instead of the battery will create a corrosion resistant connection.

- 7-6A. Route the Red and Black power supply leads to the alternator. Connect the Black (-) lead to the alternator Chassis Ground connection. Connect the Red (+) lead to the alternator Hot Lead going to the battery.

Black (-)

Red (+)



Figure 50

Replace the Protective Cover



Figure 51

Connecting the power supply leads Continued

- 7-6B. Should you choose to connect the power supply leads directly to the battery, connect the Red (+) led to the Positive (+) post of the driver's side battery. Connect the Black (-) lead to the Negative (-) post of the same battery.

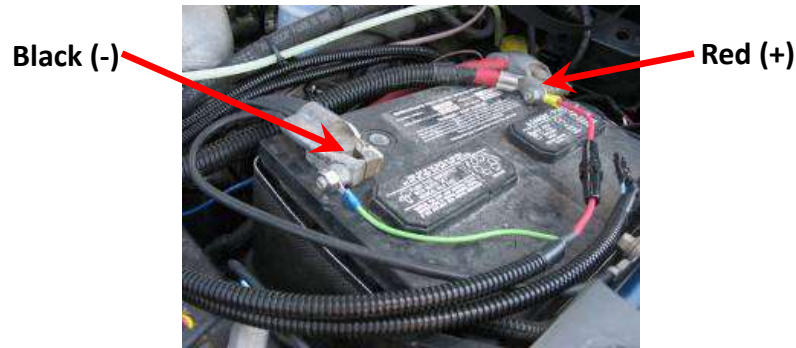

Figure 52

- 7-7. Route the wiring harness to the AirDog® and connect the 2 pin Deutsch connector to the corresponding connector on the AirDog®.



Figure 53

NOTE: If the Optional Indicator Light is not used, secure the pressure switch lead to the wiring harness with a plastic tie. Also, cover the pressure sensor lead to protect it, you may want to use it later.

INITIAL START PROCEDURE

The AirDog® is a self-priming system, however, to prevent potential damage to the system, it is recommended to fill the pre-filter with diesel fuel before initial startup.

- 8-1. Fill the water separator with diesel fuel.
- 8-2. Turn the starter key to the on/run position.
- 8-3. While the AirDog® is operating, bleed the air from the fuel line to the engine by loosening the fuel line connection at the engine fitting. As soon as the line is purged of air and pure fuel is observed, properly tighten the fuel fitting. **NOTE: put a rag or shop towel over and around fitting to prevent splatter. Catch all spilled fuel and dispose of properly.**
- 8-4. Start the engine!

RECHECK ALL FUEL FITTINGS FOR LEAKAGE AND PROPERLY TORQUE. BE SURE ALL FUEL LINES ARE PROPERLY ROUTED TO PROTECT FROM EXCESSIVE HEAT AND SECURED TO PROTECT FROM CHAFFING AND ABRASION. RECHECK ALL ELECTRICAL LINES, SECURE AS NECESSARY.

Checking Pump Noise!

NOTE: Each AirDog® has been manufactured in a Quality Controlled process and fully tested for operation and performance before shipment. This is a smooth running system. However, if any fuel fitting on the vacuum side, between the fuel tank and the AirDog® or the pre-filter, has been left loose during the installation process, the system may suck air at an excessive rate and will be very noisy. To check for this problem, unscrew the pre-filter 3 or 4 full turns and activate the AirDog® by turning the ignition switch to on. If the AirDog® runs quietly, then excessive air from a loose fitting or leaking pre-filter seal is most likely the reason for the excessive noise. Correct as necessary.

- A. The seal groove in the pre-filter is a snug fit and on occasion the seal has been found to not be fully seated. Remove the pre-filter, remove the seal from the top of the nut plate. Clean and lubricate the seal groove. Carefully replace the seal in the groove. Be sure to fully seat the seal.
- B. Check the fittings, especially the quick connect at the tank.

Filter Service Recommendations

Plugging of either the fuel filter or the water separator itself will cause low fuel pressure and low flow to the engine. If a low fuel pressure issue exists, replace the fuel filter. Typical fuel filter life is 15-20k miles depending on fuel quality.



The Water Separator

Replace the water separator every other time you change the Fuel Filter or if it becomes damaged or plugged. It is suggested to check/drain the water separator every three months or as needed should you experience excessive 'water in fuel' conditions. When installing the water separator, be sure to clean the underside of the AirDog® base. Follow the instructions printed on the pre-filter for proper tightening procedures.

CAUTION: Be extremely careful to prevent any contaminants or debris from entering the pre-filter when removing it for cleaning! Large debris will jam the Gerotor and cause the fuse to blow. This is not a warranty item. Should this happen, you can easily put the system back into working order. See the instructions on "How to clean the Gerotor" for proper procedures.

The Fuel Filter

Remove the fuel filter by turning it counter clockwise. Do not pre-fill the fuel filter with fuel. The AirDog® will fill the filter and prime the system automatically. Follow the instructions on the filter for proper tightening procedures.

CAUTION: Dispose of waste fuel and used filters properly to protect OUR environment!

Changing the Regulator Spring

The AirDog® is shipped from the factory with the fuel pressure preset.

For the 1998.5-2004 Dodge Cummins the AirDog® fuel outlet pressure is preset at 15 PSI (± 2). However, for some applications, you may desire to increase the pressure output from your AirDog®. To do this, you will need to install a higher tension spring.

Regulator Spring Replacement Procedure



The regulator spring and ball assembly is located inside the Return to Tank fuel port.

Step-1. Disconnect the 'Return to Tank' fuel line.



Figure 54

Step-2. Remove the 'Return to Tank' fuel line fitting exposing the regulator spring.

Step-3. Remove the ball and spring.



Figure 55



Figure 56



Figure 57

Step-4. Install the new regulator spring by reversing the steps 1 thru 4. Be sure to place the regulator ball in the regulator seat before inserting the spring. Properly torque the return line fitting and swivel connection when finishing.

Cleaning Foreign Debris from the Gerotor Assembly

Step 1

Remove the four (4) socket head cap crews that secure the gerotor cap.



Step 2

Carefully remove the O-ring, you will need to re-use it.



Step 3

Remove and clean the gerotor. Be very careful not to damage the gerotor.



Step 4

Clean the inside of the gerotor pocket.



Step 5

Replace the O-ring and center gear.



Step 6

Align the teeth and install the outer gear.



Step 7

Install the gerotor cap. Be very careful to index the cap to position the wide space between the half moon cuts to the bottom.



Step 8

Replace the cap into position. Be very careful, do not pinch the O-ring. Torque the cap screws in an opposing pattern.



PUREFLOW AIRDOG
LIFETIME LIMITED EXPRESS WARRANTY

FOR

Covered PureFlow AirDog I, II and Raptor Systems

IMPORTANT NOTICE

TO ACTIVATE YOUR PUREFLOW AIRDOG WARRANTY, YOU MUST COMPLETE AND MAIL YOUR WARRANTY CARD TO PUREFLOW AIRDOG WITH A COPY OF YOUR ORIGINAL SALES RECEIPT WITHIN 30 DAYS OF PURCHASE. FAILURE TO COMPLETE AND SUBMIT YOUR WARRANTY CARD WILL RESULT IN A WARRANTY PERIOD OF THE COVERED PRODUCE TO ONE (1) YEAR FROM THE DATE OF PURCHASE.

PureFlow AirDog (hereafter collectively, "SELLER") warrants and guarantees only to the Original Purchaser (hereafter collectively, BUYER) that All PureFlow AirDog Systems (hereafter collectively, PRODUCT) shall be free from defects of materials and workmanship in the manufacturing process for as long as the BUYER owns the PRODUCT.

The Lifetime Limited Express Warranty is limited to the PRODUCT purchased by the original BUYER of the PRODUCT and limited solely to the parts contained within the PRODUCT and EXCLUDES ALL ELSE INCLUDING FILTERS AND WATER SEPARATORS. Any PRODUCT that is in question of Warranty must be returned, shipped prepaid, to PureFlow AirDog. All Warranty claims are subject to the approval of PureFlow AirDog. If it is determined that a Warranty claim exists, PureFlow AirDog will, at its sole discretion, replace the defective PRODUCT with a comparable PRODUCT, repair the defective PRODUCT, or refund the BUYER'S purchase price in exchange for the PRODUCT. Repairs or replacements are warranted for only the remainder of the original warranty period and only to the original BUYER.

Under no circumstances shall the SELLER be liable for any labor charged or travel time incurred in the diagnosis for defects, removal, or reinstallation of the PRODUCT, or any contingent expense.

Under no circumstances will the SELLER be liable for any damage or expense incurred by reason of the use or sale of the PRODUCT.

Other than expressly set forth herein, the SELLER shall in no way be responsible for the proper or improper use and service of the PRODUCT. In no event shall the SELLER be liable for any special, incidental, indirect or consequential damages of any kind or nature, whether or not the BUYER of the PRODUCT was advised of the possibility of damage or harm, arising or resulting from the use or performance of the PRODUCT and BUYER hereby waives the right to any and all such claims.

BUYER, acknowledges that he/she is not relying on SELLER'S skill or judgment to select or furnish goods suitable for any particular purpose and that SELLER has no liability that will extend beyond the scope of the LIMITED EXPRESS WARRANTY contained herein, and BUYER hereby waives all remedies or liabilities, expressed or implied, arising by operation of law or otherwise.(including, without limitation, any obligation of SELLER with respect to fitness for any particular purpose; merchantability; and special, incidental, indirect or consequential damages) or whether or not occasioned by SELLER'S negligence.

SELLER disclaims any warranty and expressly disclaims any liability for personal inquiry or damages related to BUYER'S use of the PRODUCT. BUYER acknowledges and agrees that the disclaimer of any liability for personal injury is a material term for this agreement and BUYER agrees to indemnify SELLER and hold SELLER harmless from any claim related to the PRODUCT and its use or performance. Under no circumstances will SELLER be liable for any damages, liabilities, costs or expenses incurred as a result of or by reason of use, performance or sale of the PRODUCT, including without limitation, any damages, liabilities, costs or expenses incurred by reason of BUYER'S negligence related to those uses of the PRODUCT.

The proper installation of the PRODUCT is the sole responsibility of the BUYER. The SELLER assumes no liability regarding improper installation or misapplication of the PRODUCT.

SELLER hereby provides the following limited warranty as to description, quality, merchantability, fitness for the PRODUCT'S purpose, productiveness, or any other matter of SELLER'S PRODUCT sold herewith. The SELLER shall be in no way responsible for the open use and service of the PRODUCT and the BUYER hereby waives all rights other than those expressly written herein. This Warranty shall not be extended or varied except by a written instrument signed by SELLER and BUYER.

IN THE EVENT THAT THE BUYER DOES NOT AGREE WITH THIS AGREEMENT, THE BUYER MAY PROMPTLY RETURN THE PRODUCT, IN A NEW AND UNUSED CONDITION, WITH A DATED PROOF OF PURCHASE, TO THE PLACE OF PURCHASE WITHIN THIRTY (30) DAYS FROM THE DATE OF PURCHASE FOR A FULL REFUND. THE BUYER AGREES THAT THE INSTALLATION OF THIS PRODUCT CONFIRMS THE BUYER HAS READ AND UNDERSTANDS THIS AGREEMENT AND ACCEPTS THE TERMS AND CONDITIONS OF THIS AGREEMENT.

Warranty Procedure

In the unlikely event a warranty appears as if it may be warranted, the following steps are taken:

- 1 The customer discussed the symptoms of the problem with a PureFlow AirDog Technician. The customer is to have the system Serial Number and Model Number available for the Technician when the call is made. This will expedite all steps of the process.
- 2 The customer performs any and all tests requested by the PureFlow AirDog Technician. This is done to isolate the potential problem while eliminating potential installation or maintenance related issues,
- 3 If the PureFlow AirDog Technician determines based on the customer feedback concerning the requested testing that system may be at fault, the customer is advised that all returned pumps are tested upon arrival and should this returned pump perform at design criteria upon arrival, the customer will be charged a \$50.00 fee.
- 4 The PureFlow AirDog Technician will first request the customer's phone number in the event the phone call is accidentally disconnected and then transfer the customer to a PureFlow AirDog Customer Service Representative. Should a Customer Service Representative not be available, the Technician will offer the Customer the option to hold, call back, or receive a return call.
- 5 The PureFlow AirDog Customer Service Representative will check to determine if the customer's Warranty Registration Card is on file.
 - a. If no Warranty Registration is found, the customer will be required to supply the original purchase receipt showing the purchase date.
 - b. If no Warranty Registration is found, the customer will be advised of the options should the system in question is out of the default warranty period (1 year).
- 6 The PureFlow AirDog Customer Service Representative will request the customer information, including: Name, Address, Phone Number, Model Number, Serial Number, Year / Make / Model of vehicle, Name of Dealer purchased from, Purchase Date, Description of Problem, Customers' understanding of the resolution, and customer credit card information.
- 7 PureFlow AirDog will cover Ground Shipping charges to ship the replacement unit and will include a prepaid shipping label for the return of the defective unit. Any additional items ordered at the time of the replacement shipment will include their portion of the shipping cost.
- 8 A period of 15 Calendar Days from the time of shipment is provided for the receipt of the defective unit at the PureFlow AirDog facility. Failure to return ship the defective unit to arrive within the defined time period will result in a charge of \$250.00 against the customer's credit card as the purchase cost of the defective unit.