



NOT LEGAL FOR SALE OR USE ON ANY POLLUTION CONTROLLED MOTOR VEHICLE IN CALIFORNIA OR STATES ADOPTING CALIFORNIA EMISSION PROCEDURES.  
See knfilters.com for CARB status on each part for a specific vehicle

## INSTALLATION INSTRUCTIONS

# 71-1532

## DODGE

### 2003-07 Ram 2500 / 3500

### L6-5.9L Turbo Diesel

**NOTE:** This kit was not designed to fit vehicles with a body lift.

#### TOOLS NEEDED:

- Ratchet
- Extension
- 13mm socket
- 10mm socket
- 7mm socket
- Flat blade screw driver
- 13mm wrench
- 10mm wrench
- T20 Torx
- 2.5mm Allen key
- 3-16" Allen key

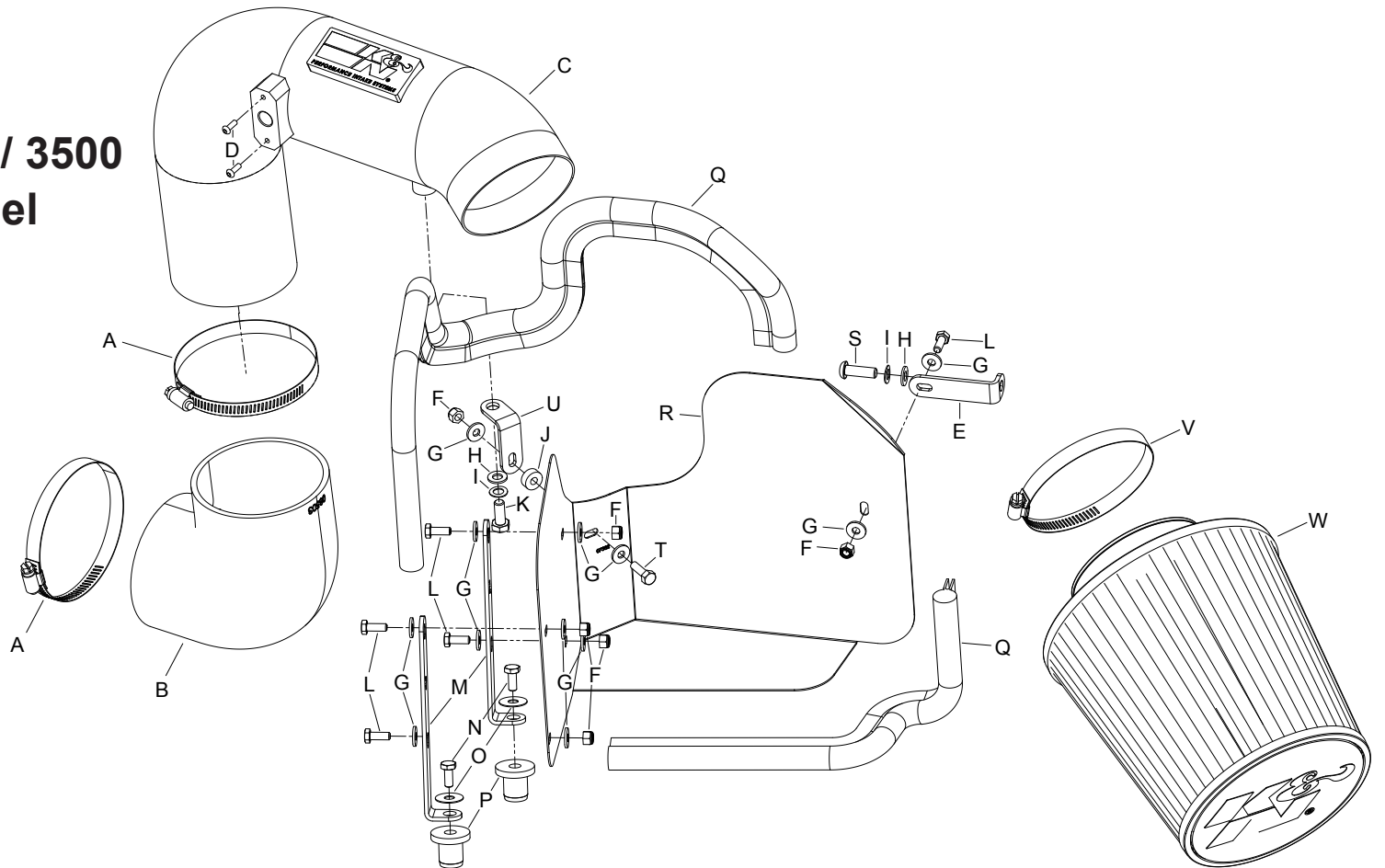

#### PARTS LIST:

Description	Qty.	Part #	Description	Qty.	Part #	Description	Qty.	Part #
A Hose Clamp #64, Black Zinc	2	08645K	I Washer; 8MM Spring (Wave)	2	08239	Q Edge Trim (50")	1	102481
B Hose; 4.0"ID 90DE, Reinforced	1	08503	J Spacer; .625"OD X 250"ID	1	06555	R Heat Shield	1	07382
C Intake Tube	1	27586TK	K Bolt; M6 X 1.00" X 20MM Hex	1	07795	S Bolt; M8-1.0 X 20MM, Tap	1	06533
D Screw; M4-.7 X 12, Buttonhead	2	07726	L Bolt; 6MM-1.00 X 16MM, SS	5	07812	T Bolt; 8MM -1.25 X 25MM	1	07748
E Bracket; 57-1532, SM. "L"	1	07158	M Bracket; 57-1532, LG. "L"	2	07159	U Bracket; 63-1015, "L", FIN	1	070712
F Nut; 6MM Nylock, Hexhead, SS	6	07512	N Bolt; 3/8"-16 X 1-1/4"L SS Hex	2	07779	V Hose Clamp #104, black Zinc	1	08697K
G Washer; 1/4"ID X 5/8"OD-SAE	12	08275	O Washer; 3/8" Flat Washer,SS	2	08134	W Air Filter	1	RU-5171-HBK
H Washer; 8MM, Flat, SS	2	08272	P Insert; 3/8-16 X 3/400 X 15/16L,	2	08163			

**NOTE: FAILURE TO FOLLOW INSTALLATION INSTRUCTIONS AND NOT USING THE PROVIDED HARDWARE MAY DAMAGE THE INTAKE TUBE, THROTTLE BODY AND ENGINE.**

#### TO START:

- Turn off the ignition and disconnect the negative battery cable.  
**NOTE: Disconnecting the negative battery cable erases pre-programmed electronic memories. Write down all memory settings before disconnecting the negative battery cable. Some radios will require an anti-theft code to be entered after the battery is reconnected. The anti-theft code is typically supplied with your owner's manual. In the event your vehicles' anti-theft code cannot be recovered, contact an authorized dealership to obtain your vehicles anti-theft code.**

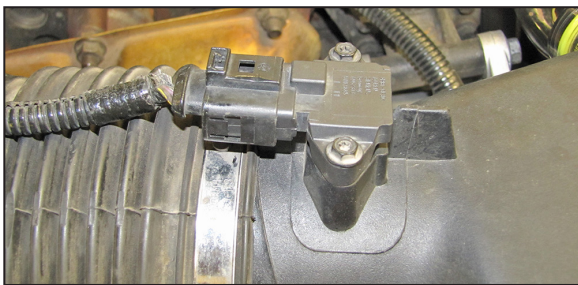

- Disconnect the inlet air temperature sensor electrical connection.

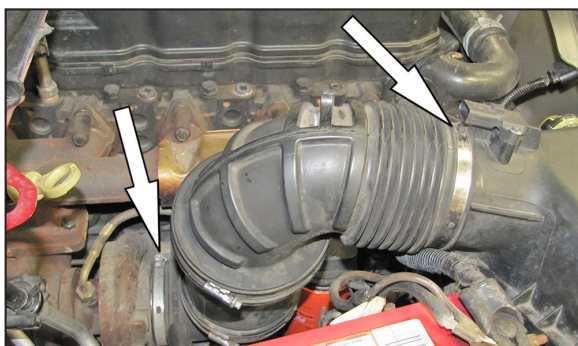

- Loosen the hose clamps securing the intake hose to the turbo inlet and to the factory air box.

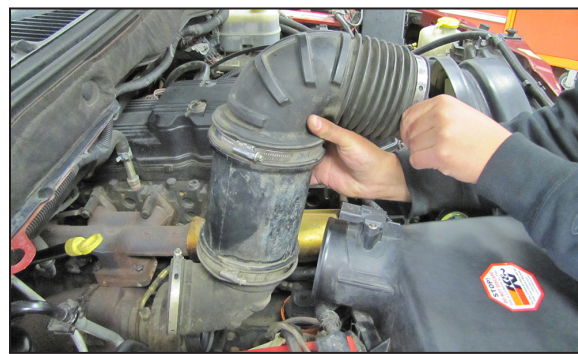

- Remove the intake hose from the vehicle.



- Remove the air box mounting bolt shown.



- Lift up the air box to dislodge it from the mounting grommets and then remove the air box from the vehicle.  
**NOTE: K&N Engineering, Inc., recommends that customers do not discard factory air intake.**

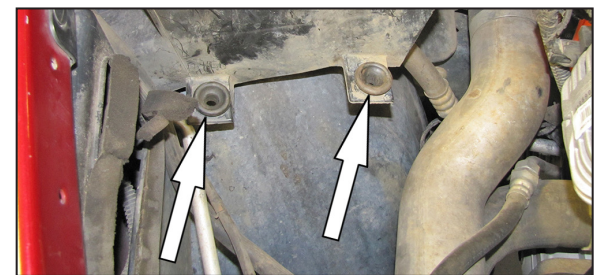

- Remove the two air box mounting grommets from the mount.

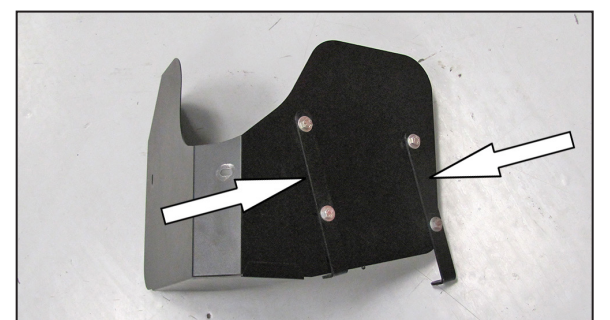

- Install the two provided heat shield mounting brackets (07159) onto the heat shield as shown using the provided hardware.

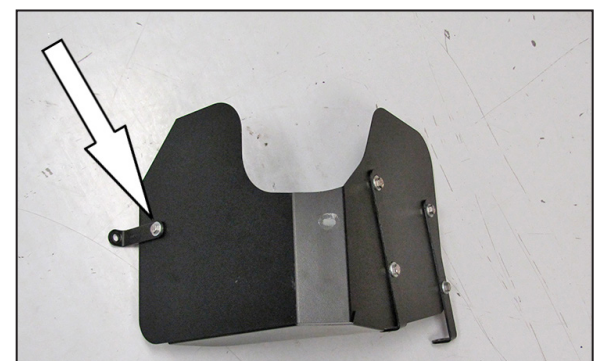

- Install the front heat shield mounting bracket (07158) onto the heat shield using the provided hardware.

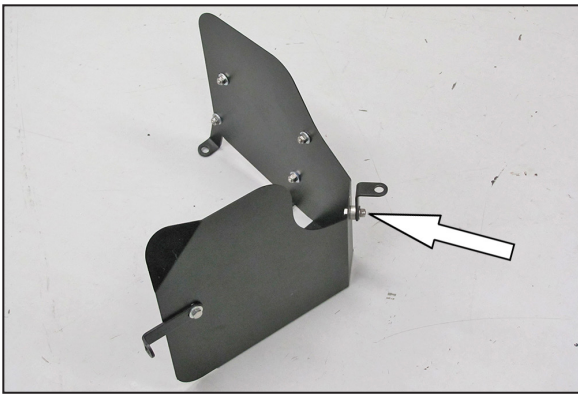

10. Install the tube mounting bracket (070712) onto the heat shield using the provided spacer and hardware as shown.

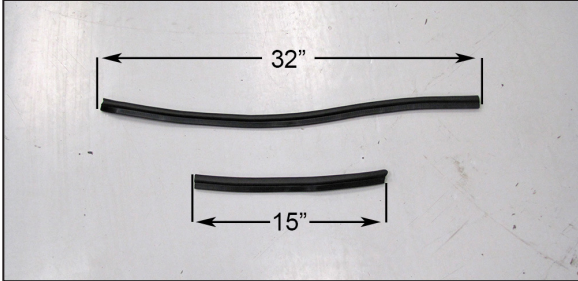

11. Cut the provided edge trim into two sections, one section is to be 32" long and the other section is to be cut at 15" long.

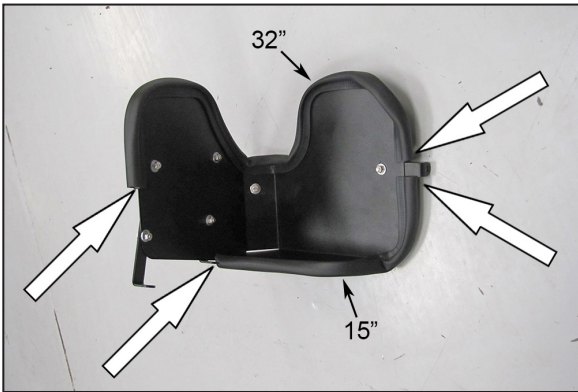

12. Install the edge trim onto the heat shield as shown.

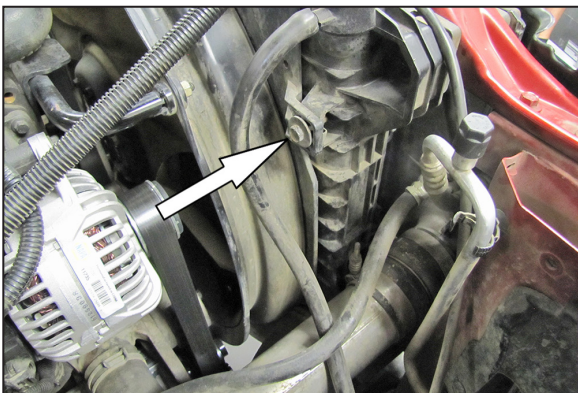

13. Remove the factory fan shroud retaining bolt shown.

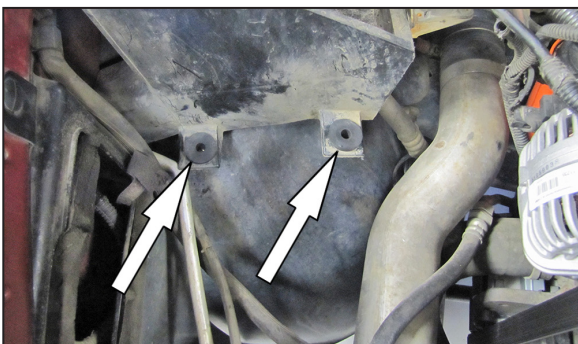

14. Install the two provided inserted nuts into the air box mounting grommet locations.



15. Install the heat shield assembly onto the inserted nuts then secure it to the fan shroud and inserted nuts with the provided hardware.



16. Install the provided 90° hose onto the turbo inlet and secure with the provided hose clamps. **NOTE: Do not completely tighten the hose clamp at this time.**



17. Remove the inlet air temperature sensor. On vehicles equipped with a filter minder, remove the filter minder and grommet from the air box.



18. Install the inlet air temperature sensor into the K&N® intake tube as shown.



19. On vehicles equipped with a filter minder, drill a 5/8" id hole 6" from end of tube and then install the factory filter minder and grommet.



20. Install the K&N® intake tube into the silicone hose installed during step #16 and align with the mounting bracket installed onto the heat shield. Adjust the hose and tube for proper fit and then secure the hose and tube with the provided hardware.

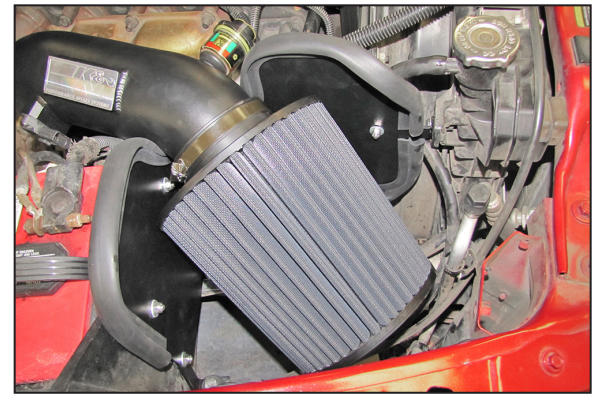

21. Install the K&N® air filter onto the K&N® intake tube.

**NOTE: It may become necessary to loosen the intake tube to allow the filter enough room to be installed.**



22. Reconnect the inlet air temperature sensor electrical connection.



23. Reconnect the vehicle's negative battery cable. Double check to make sure everything is tight and properly positioned before starting the vehicle.

24. It will be necessary for all K&N® high flow intake systems to be checked periodically for realignment, clearance and tightening of all connections. Failure to follow the above instructions or proper maintenance may void warranty.

#### ROAD TESTING:

1. Start the engine with the transmission in neutral or park, and the parking brake engaged. Listen for air leaks or odd noises. For air leaks secure hoses and connections. For odd noises, find cause and repair before proceeding. This kit will function identically to the factory system except for being louder and much more responsive.

2. Test drive the vehicle. Listen for odd noises or rattles and fix as necessary.

3. If road test is fine, you can now enjoy the added power and performance from your kit.

4. K&N Engineering, Inc., requires cleaning the Blackhawk Induction™ intake system's air filter element every 100,000 miles. When used in dusty or off-road environments, our filters will require cleaning more often. We recommend that you visually inspect your filter once every 25,000 miles to determine if the screen is still visible. When the screen is no longer visible some place on the filter element, it is time to clean it. To clean, purchase our Synthetic Filter Cleaner, part number 99-0624 and follow the easy instructions.

**NOT LEGAL FOR SALE OR USE ON ANY POLLUTION CONTROLLED MOTOR VEHICLE IN CALIFORNIA OR STATES ADOPTING CALIFORNIA EMISSION PROCEDURES.**

See [knfilters.com](http://knfilters.com) for CARB status on each part for a specific vehicle