



Installation Manual for 1998.5-2002 Dodge 24V Cummins Version 3.1

Please read all instructions before the installation of the ATS Co-Pilot

Thank you for purchasing the ATS Co-Pilot torque converter / exhaust brake controller. This manual will assist installation and operation of the unit. If installing the unit for a customer, **please pass this manual on to the customer** for future reference.



Understanding the ATS Five Star Co-Pilot

The ATS Co-Pilot transmission controller is recommended for use with light duty pickup trucks when a heavy-duty aftermarket transmission and torque converter package have been installed on vehicle. While the Co-Pilot will still function perfectly on a stock transmission, factory transmission shafts are weak and prone to breakage. The factory torque converter clutch will also fail if applied under high load conditions. Factory computers are programmed to disengage lockup under certain conditions which will protect the transmissions internal components under higher load. This is why we recommend having a heavy-duty aftermarket transmission installed in your vehicle to prevent transmission failure. ATS Diesel Performance sells many parts for all levels of trucks that will strengthen your transmission and improve reliability, whether you have a stock daily driver or a fully built race truck! Give us a call today if you feel the need to get a fully rebuilt transmission for your truck, or if you just want to strengthen your current transmission with a few upgraded parts. Our experts can help answer any questions you have and guide you in the right direction.

Co-Pilot Adjustment

The control panel on the face of the ATS Co-Pilot allows the driver to adjust the lockup of the transmission. Keep in mind that the Co-Pilot will only lock the torque converter when enough boost is reached. This keeps the engine from bogging down due to excessively early converter clutch lockup that is commanded by many factory transmission control modules. The adjustments allow you to trim the converter clutch lockup based on MPH. To raise the vehicle speed at which the transmission locks up you press the up arrow button. To decrease lockup speed press the down arrow button. When the torque converter is locked, the Co-Pilot will display a green light to indicating that the converter has locked up. Due to the protection the Co-Pilot provides and the engine load sensing of the Co-Pilot it is not possible to command Lock-up at too low an engine speeds or low torque levels. This unique feature ensures the engine will never bog or run at a low engine RPM, causing lugging when the engine does not have boost. At the other end of the spectrum during high power output when the engine is running at full load, the Co-Pilot will keep the torque converter clutch engaged allowing full torque to be transferred through the torque converter clutch to the transmission input shaft. The factory often disengages the torque converter clutch during these high torque conditions to reduce the load exerted on the factory transmission shafts. This is the primary reason we do not recommend installing a Co-Pilot transmission controller on a stock torque converter or transmission.

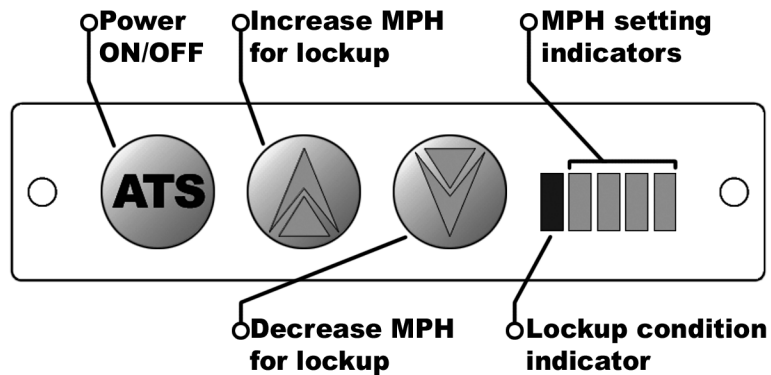

Figure 1: Co-Pilot Face Plate Configuration

The ATS Co-Pilot will need to be set up for your vehicle and application. The Co-Pilot will need to be disassembled to access the dip switches on the electronic board. You will need a 1/16th - inch hex (Allen wrench) to remove the face from the Co-Pilot. After the face has been removed the electronic board can be slid out of the casing from the front. The digital face is attached to the circuit board with a ribbon cable; do not force the board from the case. There are four (4) switches on the circuit board; the switches allow the user to select the features desired. The settings are listed below. When reinstalling the face on the Co-Pilot do not over tighten the 2 small screws on the face or faceplate failure will result.

Dip switch selection:

Switch #1

If your Dodge's transmission has a stock valve body flip #1 switch to **ON** position
If your Dodge's transmission has an ATS valve body flip #1 switch to **OFF** position

Switch #2

Automatically cancels OD from a stop, only cancels after ignition has cycled, cancels at speed above 3mph.

IMPORTANT: If the white wire of the Copilot harness is not connected, then switch #2 must be set to the "ON" position. With the wire connected the options below are available.

If you want automatic OD cancel from a stop flip #2 switch **ON**
If you **do not** want automatic OD cancel from a stop flip #2 switch **OFF**

Switch #3

Speed setting

On=low speed cut out (deceleration only) This setting is designed to be used with an exhaust brake.

Off=Hi speed cut out (deceleration only)

Switch #4

Set this switch to the **ON** position

We have preset the Co-Pilot module #1-ON, #2-ON, #3-OFF, #4-ON

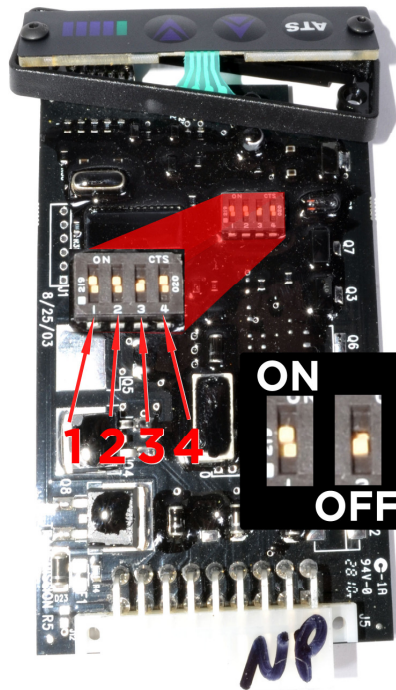

Co-Pilot Controller Mounting Location

Find a convenient location to mount the Co-Pilot with in reach and view of the driver. The Co-Pilot must be within visual range of the driver and mounted in an easy to reach location. We have found the ideal place to locate the module is just to the right of the driver on the lower dash panel just above the right knee. However, if you find a more desirable location to install your Co-Pilot feel free to move it. Just make sure you have enough length in the harness, otherwise an extension harness can be purchased. Use the Velcro supplied to secure it to the dash. Before sticking the Velcro to the dash use brake clean, acetone, or any other powerful cleaner on the area the Velcro will be applied. Carefully run the Co-Pilot wires that are to be wired to the PCM (Power-train control module) and the transmission through the firewall.



Wiring the Co-Pilot

The Co-Pilot has several connections that need to be made in order for it to function properly. There are several wires which are optional but still included to give the Co-Pilot a more versatile use depending on your trucks current setup. Use the diagram below as a reference when installing your Co-Pilot to avoid any conflicts or confusion.

PCM CONNECTORS

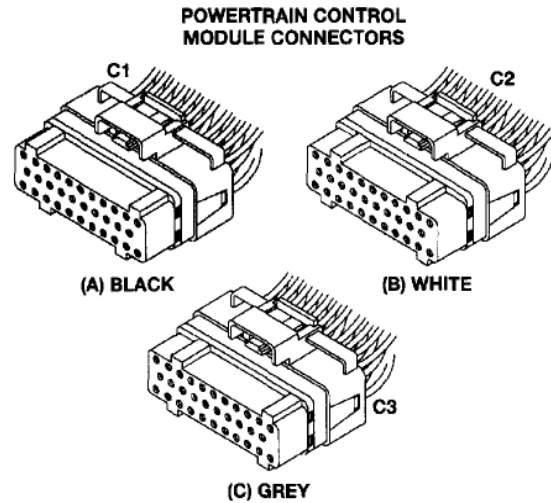
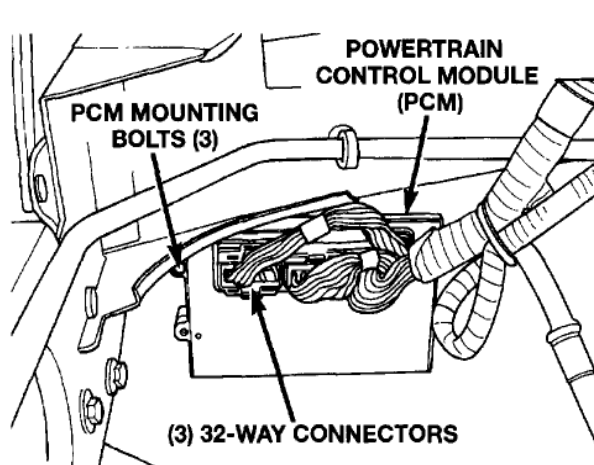

CAV	COLOR	FUNCTION
A2	F18 LG/BK	Fused Ignition Switch Output
A4	K4B BK/LB	Sensor Ground
A6	T41 BK/WT	P/N Position Switch Sense
A8	K24 GY/BK	Crank Position Sensor Signal From ECM
A22	A14 RD/WT	Fused B (+)
A23	K22 OR/DB	Accel Pos Sensor Signal
A31	Z12 BK/TN	Ground
A32	Z12 BK/TN	Ground
B1	T54 VT	Trans Temp Sensor Signal
B8	K88 VT/WT	Governor Pressure Solenoid Control
B10	K20 DG	Generator Field Driver
B11	K54 OR/BK	TCC Solenoid Control
B21	T60 BR	Overdrive Solenoid Control (3-4 Shift)
B25	T13 DB/BK	Output Shaft Speed Sensor Signal (-)
B27	G7 WT/OR	Vehicle Speed Sensor Signal
B28	T14 LG/BK	Output Shaft Speed Sensor Signal (+)
B29	T25 LG/WT	Governor Pressure Signal
B30	K30 PK	Transmission Relay Control
B31	K7 OR	5-Volt Supply Secondary

CAV	COLOR	FUNCTION
C1	C13 DB/OR	A/C Comp Clutch Relay Control
C3	K51 DB/YL	Auto Shutdown Relay Control
C4	V36 TN/RD	S/C Vacuum Solenoid Control
C5	V35 LG/RD	S/C Vent Solenoid Control
C6	T18 LG/OR	Overdrive Off Lamp Driver
C11	V32 YL/RD	Speed Control Power Supply
C12	A142 DG/OR	Auto Shutdown Relay Output
C13	T6 OR/WT	Overdrive Off Switch Sense
C15	K118 PK/YL	Battery Temp Sensor Signal
C22	C20 BR	A/C Request Signal
C23	C90 LG/WT	A/C Select Signal
C24	V40 WT/PK	Brake Switch Sense
C25	T125 DB	Generator Field Source (+)
C26	K226 DB/WT	Fuel Level Sensor Signal
C27	D21 PK/DB	SCI Transmit
C28	D2 WT/BK	CCD BUS (-)
C29	D220 LG	SCI Receive
C30	D1 VT/BR	CCD BUS (+)
C32	V37 RD/LG	Speed Control Switch Signal

-Red Wire- +12V Power – PIN #1

Reasons for use: The red wire supply's key on power to the Co-Pilot so it can turn on and be functional. **NOT OPTIONAL**

Locate the PCM power wire in the vehicle's wiring harness. Tap the **Lt Green w/ Black** wire that runs to pin 2 of the **C1** PCM connector (PCM connectors are behind the air box on the passenger-side firewall, the C1 connector is the one closest to the engine).

-Black Wire- Ground (GND) – PIN #9

Reasons for use: The black wire is a constant ground which is required for the Co-Pilot to turn on and be operational. **NOT OPTIONAL**

Locate the PCM ground wire in the vehicle's wiring harness. Tap the **Black w/ Tan** wire that runs to pin **32** of the **C1** PCM connector (PCM connectors are behind the air box on the passenger-side firewall, the C1 connector is the one closest to the engine).

-White Wire- Overdrive – PIN #5 (* OPTIONAL *)

Reason For use: This wire give the Co-Pilot the ability to automatically cancel overdrive.

Notes: This changes the shift point of the 3 to 4th gear shift. To remove this function just do not hook up wire or cut white wire.

Locate the OD (Overdrive) wire in the vehicle's computer wiring harness. This **Orange w/ White** stripe wire is located at pin **13** of the C3 PCM connector (PCM connectors are behind the air box on the passenger-side firewall, the C3 connector is the one closest to fender). Run the white wire from the **ATS Co-Pilot** to the OD wire from the PCM and cut off any excess, but leave some slack. Tap the Co-Pilot white wire into the wiring harness and solder the connection to the OD wire. Use heat shrink or an equivalent to protect it from the elements.

-Yellow Wire– PCM - PIN #10 and -Blue Wire– TCC - PIN #11

Reasons for use: These wires control the torque converter clutch solenoid. These wires ground the torque converter clutch allowing the Torque converter to be a 1 to 1 gear ratio.
NOT OPTIONAL

Locate the vehicle's torque converter clutch (TCC) wire coming from the vehicle's PCM to the transmission. This **Orange w/ Black** stripe wire is located at pin **11** on the PCM's **C2** connector (behind the air box on the passenger-side firewall, C2 is the center connector), *OR* at the transmission connector pin #7 (8-pin connector on driver's side of the transmission). Cut this wire and solder or attach a butt connector to the wire leading back to the transmission and attach a butt connector to the wire heading to the vehicles computer (PCM). Reference the supplied wiring schematic before cutting wire.

Connect the **Yellow** wire coming from the Co-Pilot to the wire that goes to the PCM. Connect the **Blue** wire coming from the Co-Pilot to the wire that goes to the transmission. Protect these connections. If at anytime you would like to bypass the Co-Pilot's operation, simply disconnect the wiring harness from the Co-Pilot and jump the harness blue and yellow terminals together with a paperclip.

-Pink Wire- Accelerator Pedal Position Sensor (TPS) – PIN #12 (* OPTIONAL *)

Reason For use: This wire give the Co-Pilot the ability to lock the torque converter on deceleration. This gives the vehicle an engine-braking effect. Recommended. **OPTIONAL**

Locate the TPS, it is under a black plastic cover, on the driver's side of the engine, in front of the intake manifold. Tap the **Lt. blue w/ black wire** in the TPS plug wire loom. Protect the connection with heat shrink.

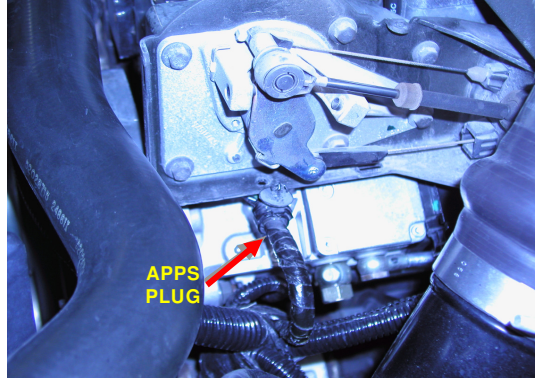

ACCELERATOR PEDAL POSITION SENSOR

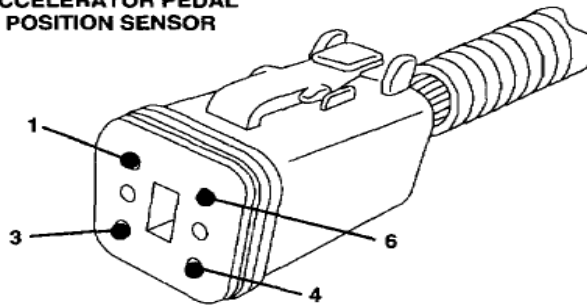

CAV	COLOR	FUNCTION
1	BK/LB	SENSOR GROUND
2	LG/DB	IDLE VALIDATION (NOT IDLE)
3	LB/BK	APP SENSOR SIGNAL
4	BK/YL	SENSOR RETURN (APPS)
5	DB/WT	5-VOLT SUPPLY
6	BR/OR	IDLE VALIDATION (IDLE)

80b4b8a6

We recommend going to the source for the TPS sensor because there are aftermarket products that rescale the TPS sensor signal. The Co-Pilot needs the original signal for the best performance.

-Green Wire- Vehicle Speed Sensor (VSS) – PIN #17

Reasons for use: This is how the Co-Pilot is able to know what speed of the vehicle is traveling so it can control the TCC lock up speed. **NOT OPTIONAL**

Locate the VSS (Vehicle Speed Sensor) wire. This **White w/ Orange** stripe wire is located at pin **27** on the PCM's C2 (behind the air box on the passenger-side firewall, C2 is the center connector).

Run the green wire from the Co-Pilot to the VSS wire at the PCM and cut off any excess, leaving some slack. Tap the Green wire into the VSS wire using solder and protect the connection from the elements using heat shrink or an equivalent.

-Purple Wire- PIN #16

Reasons For use: This allows the Co-Pilot to sense the position of the manual valve. **NOT OPTIONAL**

You must tap the **Black w/ White** stripe wire at either the PRNDL switch (3 pin connector) on the driver's side of the transmission (center wire), or at the PCM (behind the air box on the passenger side firewall, grey connector) in **24**. Run the purple wire from the Co-Pilot module to the wire. Solder the purple wire to this PRNDL wire. Protect this connection with heat shrink.

-Grey Wire- Exhaust Brake – PIN #13

Reason for use: This function allows your aftermarket or factory exhaust brake to turn on when the Co-Pilot demands torque converter lockup, only when decelerating. **OPTIONAL**

If you do not have an exhaust brake, leave the Grey wire unconnected.

Locate the exhaust brake solenoid. There should be 2 wires coming off of the solenoid. One wire delivers power to the solenoid via a power switch mounted inside the cab. The other wire supplies ground to the solenoid. The ground wire that comes from the solenoid to the ground on the engine must be removed and connected to the grey wire that comes from the Co-Pilot module. The exhaust brake feature of the Co-Pilot will only work with an exhaust brake that uses a solenoid to actuate it. We recommend the use of a PACBRAKE with our Co-Pilot. Some exhaust brakes do not use a solenoid, instead they use a computer module. In this case you will need to add a relay in the circuit to control the exhaust brake or use the Co-Pilot as a stand-alone unit. We have supplied wiring diagrams that detail the connection to your PACBRAKE.

-Diode- All models with Exhaust Brake

Place the supplied diode across the positive and negative post of the solenoid. There is a stripe on the diode that indicates the positive side. Place the stripe to the positive post of the solenoid. See the provided wiring diagram for clarification.

Recommended Exhaust Brake Wiring

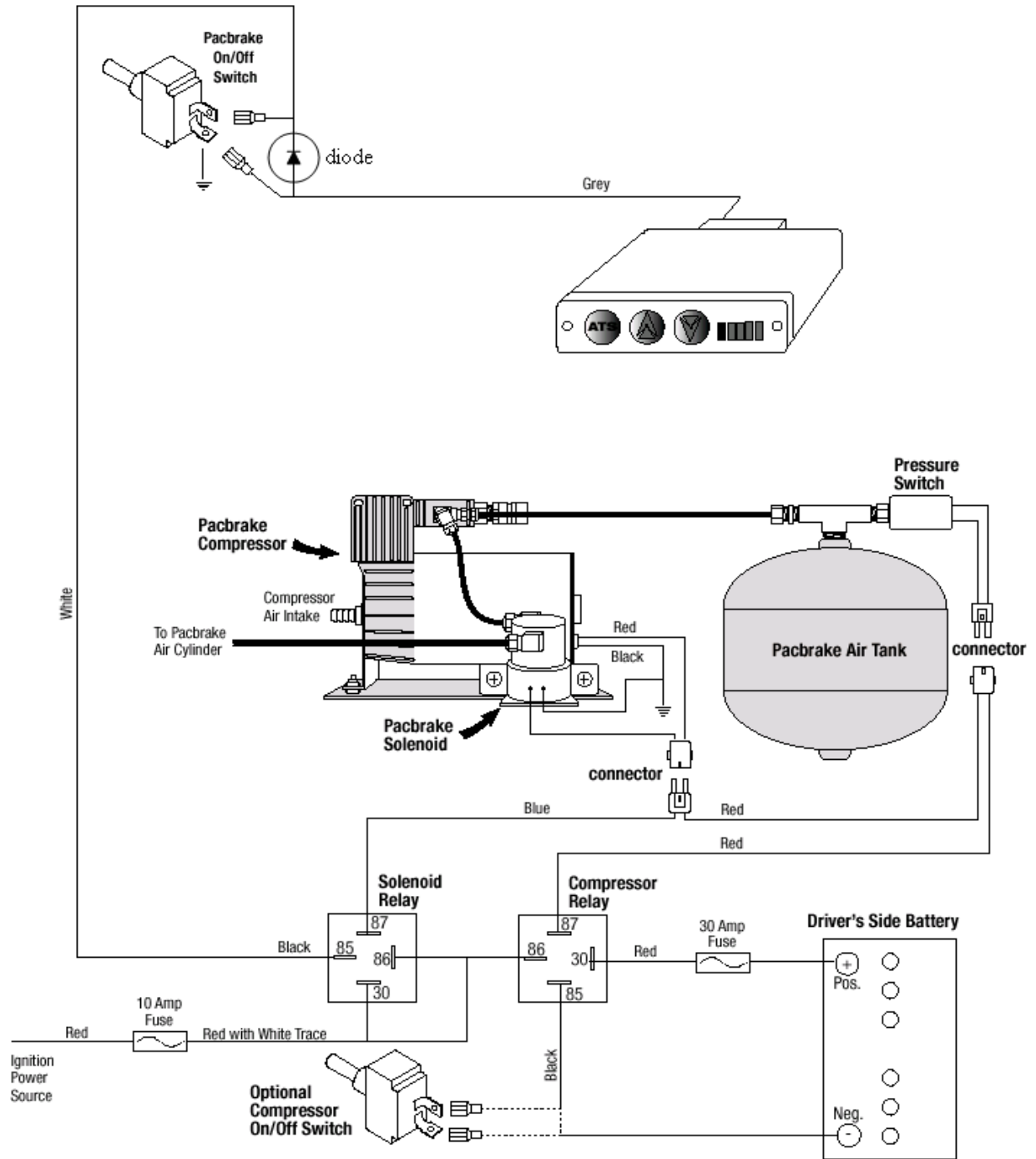



Co-Pilot Lockup Controller Dodge 1998.5-2002

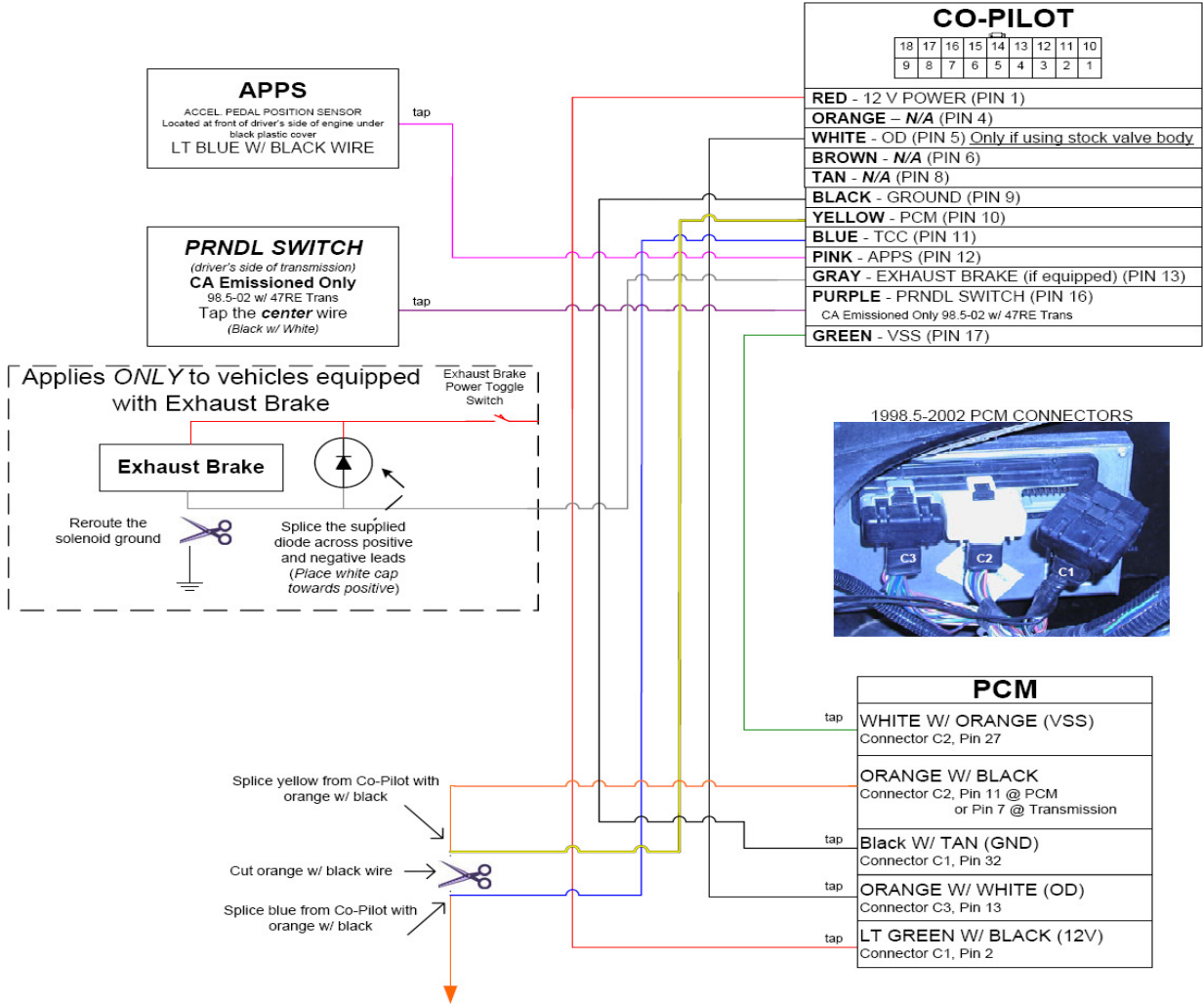

Troubleshooting

If you experience problems after installation, there is a simple test to help diagnose the problem. Simply unplug the wiring harness from the back of the Co-Pilot and **put a bent paperclip into blue and yellow terminals of the harness' plug** (jumper the blue and yellow together). This reconnects the wire that you cut at the transmission plug and bypasses the Co-Pilot completely.

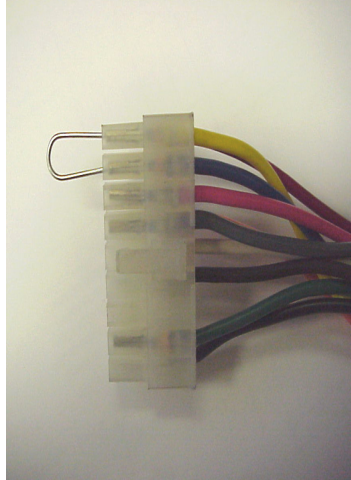

If your pickup behaves normally after bypassing the Co-Pilot: Make sure you are following the operating instructions correctly and that all wire connections are good and to the proper wires. If the problem continues, contact our Technical Support department at Tech@ATSDiesel.com or 800-949-6002.

If the problem continues after bypassing the Co-Pilot: There is a problem with a wire connection. Double-check all connections. Make sure your solder connections are good, if any look suspect, re-solder. Make absolutely sure that all taps were made on the correct wires. Some of these wires can be easily confused with neighboring ones especially if the connection was made away from the plug, inside the wiring harness. If the problem continues, contact our Technical Support department at Tech@ATSDiesel.com or 800-949-6002.

Have Any Questions?

Thank you for purchasing the ATS Co-Pilot. Please check our website at <http://www.atsdiesel.com> for technical support and other performance products such as the 5-Star™ torque converter, ATS Valve Body and ATS Transmission along with our full line of products please call or e-mail our Technical Service Department, 8:00am to 5:30pm Mountain Standard Time, Monday through Friday.

Contact Information

Toll Free: 800-949-6002

Local: 303-431-7973

Fax: 303-431-0135

Website: www.ATSDIESEL.com