

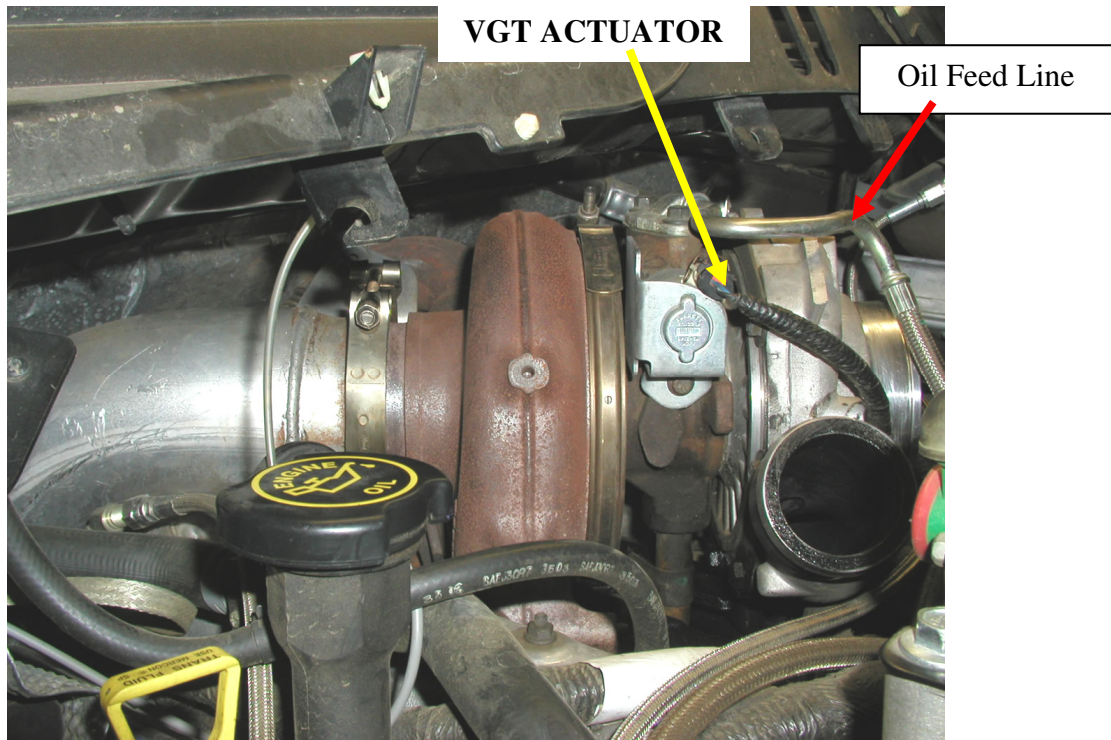

**Ford 6.0L Aurora Turbo Installation v1.6  
2003-2007 Ford 6.0L Powerstroke**

**Please read all instructions before installation.**

1. Begin by disconnecting the negative terminals of both batteries.
2. Find the VGT actuator on the stock turbo. There will be a two-wire plug-in harness with a Dark Blue wire and a Black wire that has a Light Blue tracer. Disconnect the harness and remove the VGT actuator from the turbo. Once the actuator has been removed, re-connect the harness and secure the actuator in a safe location. The Ford computer will generate a code if the actuator is not connected to the engine harness.



3. Fully loosen the down-pipe clamp as well as the up-pipe clamp.
4. Remove the air intake at the turbo.
5. Remove the compressor discharge/intercooler pipe.
6. Disconnect the oil feed line on the turbo (2 bolts).

7. Remove the other end of the oil feed line from the engine valley (1 bolt), and in place of it install the supplied fitting and hold-down clip. (Put a dab of oil on the fitting's o-ring) Early 6.0L engines have a threaded hole in the oil feed location. Use the threaded fitting supplied in the kit for the early 2003 configuration.

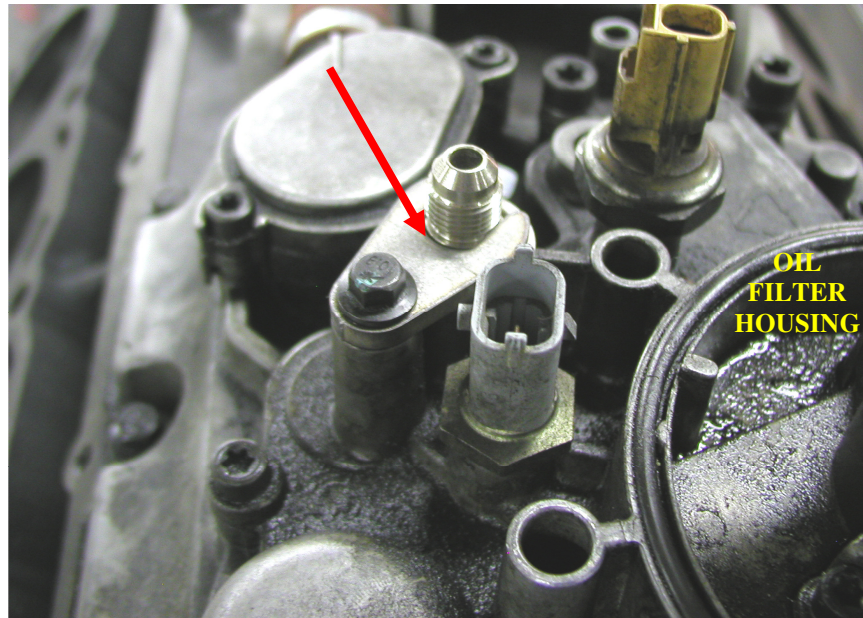

8. Remove the stock turbo from the stock pedestal (3 bolts).
9. Remove the stock pedestal from the engine (4 bolts).
10. OPTIONAL: If you haven't already installed an EGR blocker plate, now is a convenient time to do so. The blocker plate is for off-road use only.

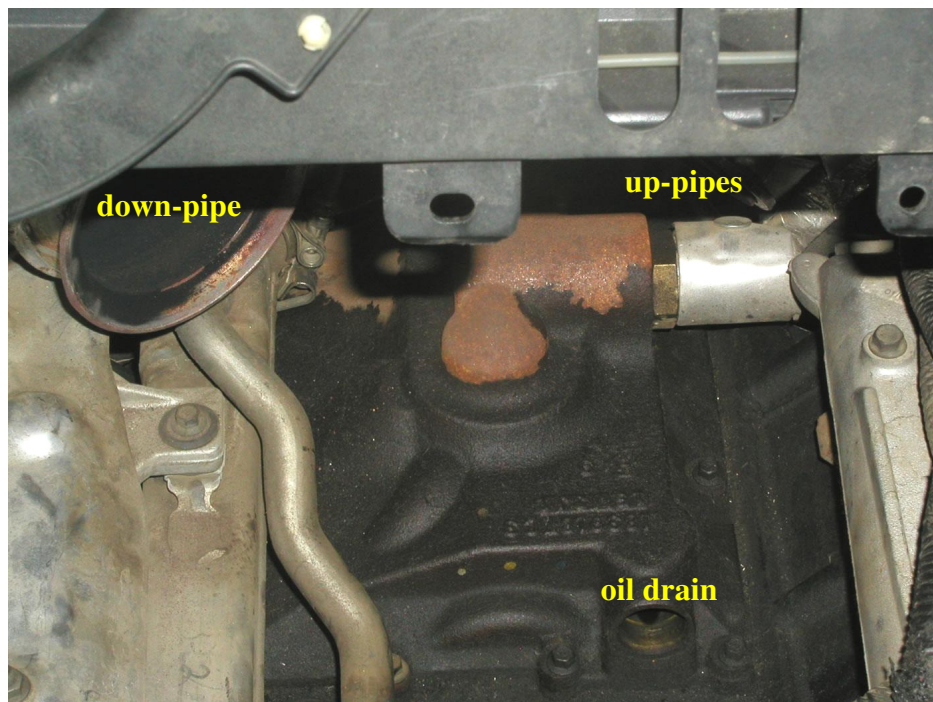

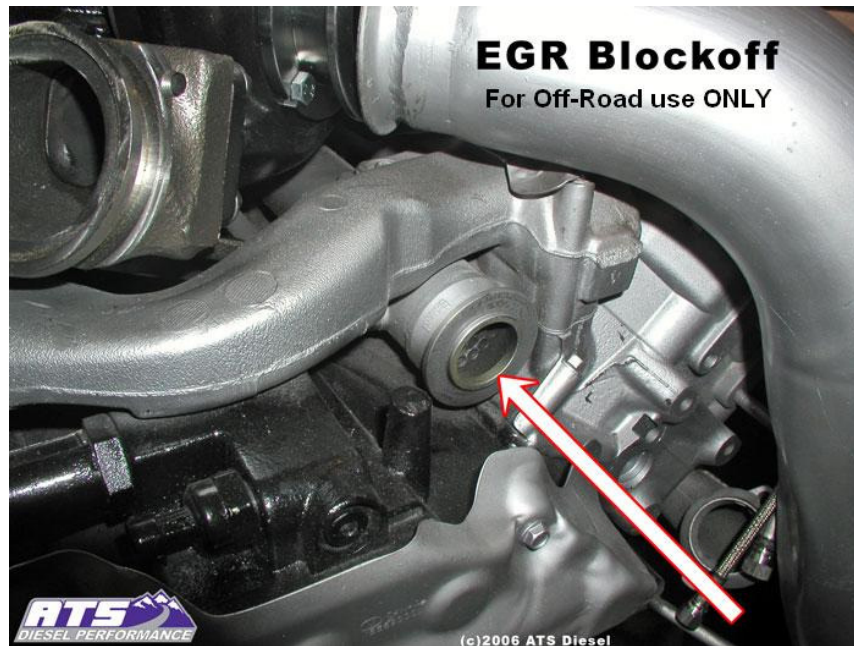

11. Position the new pedestal in the engine valley and lightly tighten the clamp between the up-pipes and the pedestal. Leave the clamp loose enough that the pedestal can rotate in relation to the up-pipes.
12. Install the 4 supplied 8mm bolts (Brass colored). If necessary, move the pedestal with a pry bar to line up the holes. Don't tighten any of the bolts until all four are started.

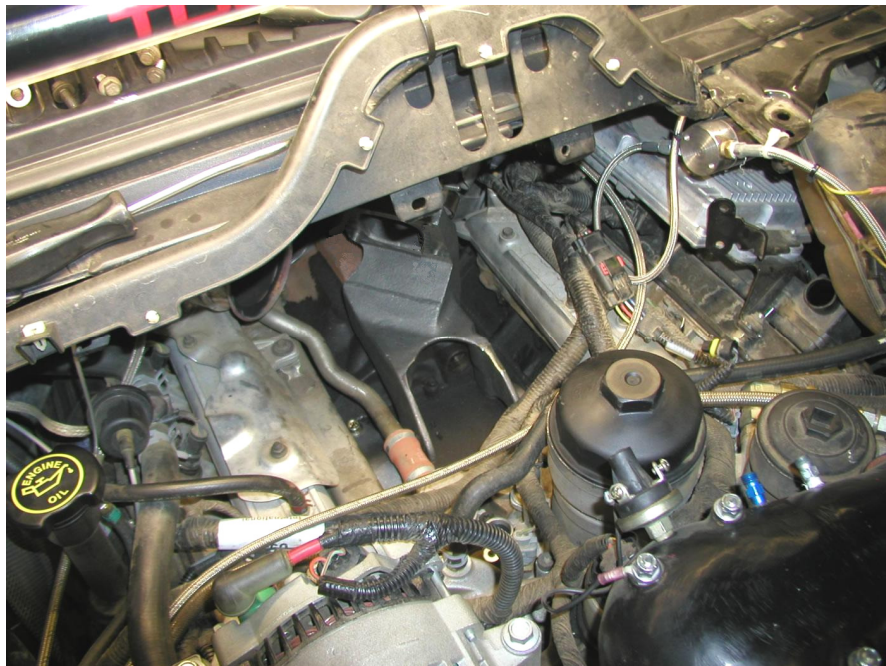

13. Tighten the up-pipe clamp.
14. Install the drainpipe onto the turbo (Don't forget the gasket!) with the two supplied black bolts.
15. Dab some oil on the drain tube o-ring.
16. Carefully lower the turbo into the engine valley, line up the oil drain and attach the turbo to the pedestal with the 4 supplied black bolts (Don't forget the gasket!). Make sure the oil drainpipe is properly lined up before tightening the four turbo flange bolts. (You should not be able to see the o-ring when the drain tube is properly installed into the port in the engine valley)
17. With the drainpipe installed and the four flange bolts tight, tighten the cartridge bolts to properly "clock" the turbo.
18. Attach the down-pipe to the turbo flange and tighten the clamp.
19. We recommend adding some oil to the oil inlet of the turbo at this time to ensure that it is properly lubricated for the initial start-up.
20. Install the supplied oil feed fitting into the top of the turbo.
21. Install the braided oil line to the fitting on top of the turbo to the new fitting in the valley.
22. Remove the stock crankcase evacuation tube from the air inlet; install the supplied 1" air inlet and spring clamps. Re-use the air inlet tube that mounted up to the valve cover. (Note: Air Inlet tube will not bolt to existing hold down bracket. The tube will be held by hose clamps at the turbo inlet and the air box outlet)
23. If your kit included the AFE air intake kit, install it and tighten the clamp to the turbo inlet.
24. Double-check the bolts and clamps.
25. Mount the supplied electronics behind the grill in front of the radiator. Use the four screws provided to secure the bracket to the plastic grill support.
26. Route the wires around the radiator supports up to the ECM.
27. The smaller black box on the electronics bracket is the vane position box shown on the schematic below. The larger box 4" x 2" is the multifunction box.
28. The ECM is located on the driver side of the engine compartment and has three large connectors. Disconnect the two labeled C1381a and C1381c in the picture below. Using a small screw driver or pick, carefully remove the connector covers so that the pin location numbers are visible.

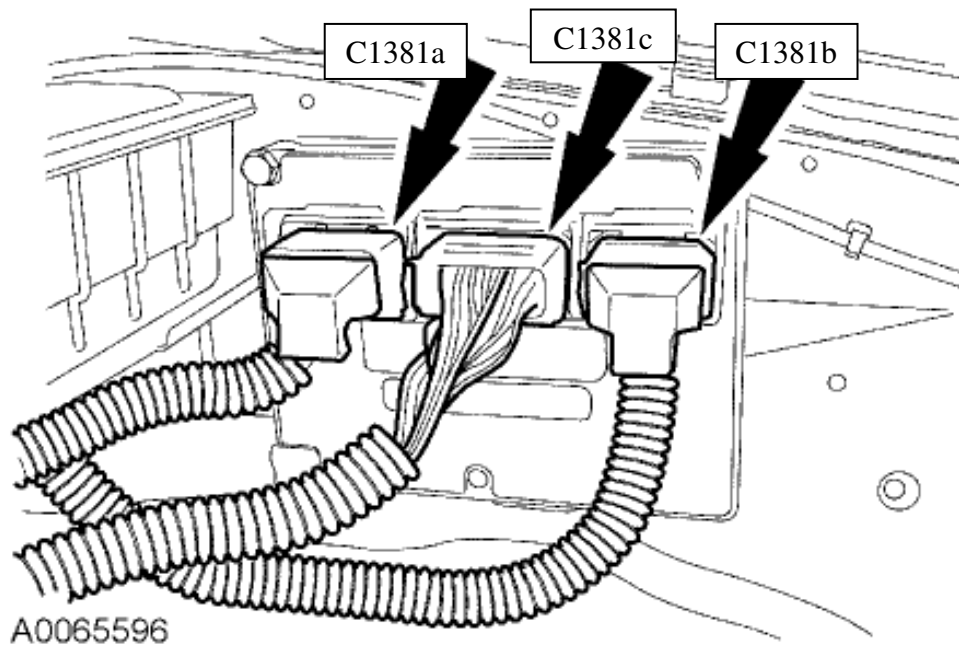

29. Connect the grey wire of the ATS electronics to the brown with white tracer (BN/WH) wire in pin 36 of connector C1381c.
30. Connect black wire of the ATS electronics to a good chassis ground.
31. Locate the violet with light blue (VT/LB) tracer wire in pin 27 of connector C1381c. Cut the wire approximately 6-8 inches away from the connector. Connect the green wire of the ATS electronics to VT/LB wire that is still connected to the ECM.
32. Connect the white wire of the ATS multifunction box to the VT/LB wire that leads away from the ECM connector to the EBP sensor.
33. Locate the light green with black tracer (LG/BLK) wire in pin 41 of connector C1381a. Cut the wire approximately 6-8 inches away from the connector. Connect the yellow wire of the ATS electronics to the section of the LG/BLK wire that leads to the ECM connector.
34. Connect the blue wire of the ATS multifunction box to the LG/BLK wire that leads away from the ECM connector to the MAP sensor.
35. Locate the brown with white tracer (BN/WH) wire in pin 36 of connector C1381c. Tap the gray wire of the ATS multifunction box into the BN/WH wire.
36. Locate the light blue orange tracer (LB/OG) wire in pin 33 of connector C1381c. Tap the purple wire of the ATS electronics into the LB/OG wire.
37. Locate the dark blue with light green tracer (DB/LG) wire in pin 29 of connector C1381c. Tap the red wire of the ATS electronics into the DB/LG wire.

38. Locate the dark blue and black with light blue tracer in pins 10 and 11 of connector C1381c. Tap the blue and white wire into these wires as shown in the following table.

	2003-04	2005	2006-07
Blue Wire	Pin 10 (BK/LB)	Pin 11 (BK/LB)	Pin 10 (DB)
White Wire	Pin 11 (DB)	Pin 10 (DB)	Pin 11 (BK/LB)

NOTE: Some factory harnesses do not follow the rules in the above table. If a P0299 code is set or the truck feels like it is in "limp-mode", switch the blue and white wires and try it again. Wiring them backwards will not harm the PCM or Turbo Electronics.

39. Verify that the connections made correspond with the schematic.
40. Reconnect the batteries
41. Double check that the VGT solenoid is connected to the engine harness and secured in a safe place in the engine compartment.
42. Start the vehicle and let it idle for a few minutes check for oil leaks.
43. Take the truck for a test drive. ATS suggests mild driving for the first 100 miles.
44. Check again for oil leaks.



**2003-2007 6.0L Power Stroke  
Turbo Electronics  
Code Blocker Kit Schematic rev E**

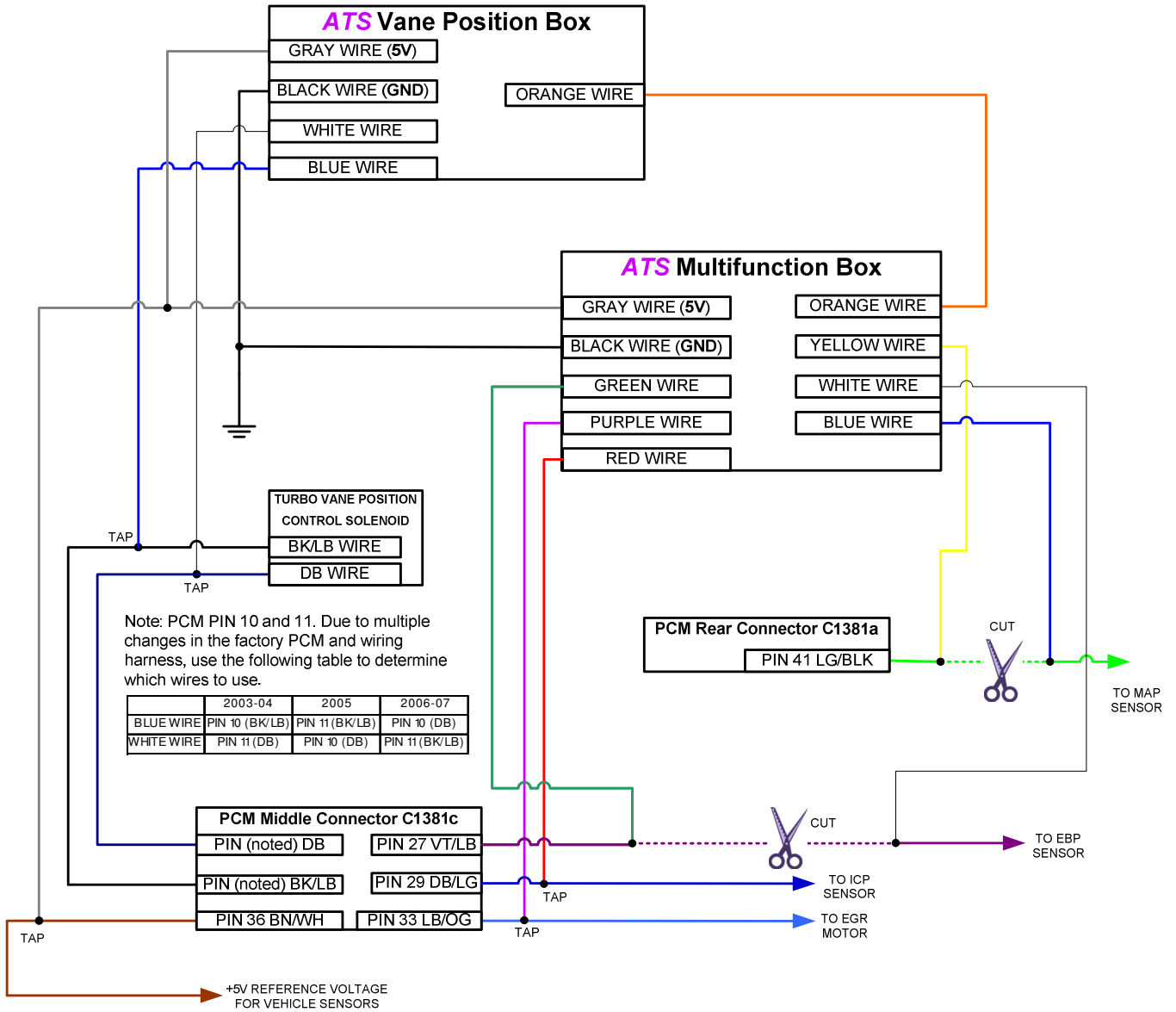

**Have Any Questions?**

Thank you for purchasing the ATS Aurora Turbo Kit for the 6.0L Power Stroke. Please check our website at <http://www.atsdiesel.com> for technical support and other performance products such as the 5-Star™ torque converter, ATS High Performance Valve Body and ATS High Performance Transmission along with our full line of power enhancers. Please call or e-mail our Technical Service Department, 8:00am to 5:30pm Mountain Standard Time, Monday through Friday.

**Contact Information**

Toll Free: 800-949-6002

Local: 303-431-7973

Fax: 303-431-01135

Website: [www.ATSDiesel.com](http://www.ATSDiesel.com)

Email: [info@ATSDiesel.com](mailto:info@ATSDiesel.com)

We strive to make our instructions as clear and complete as possible. To achieve this, our instructions are under constant construction. We encourage you to visit our Technical Support Website (<http://www.atsdiesel.com/ATSWebsite/Technical.asp>) to check for the most up-to-date manuals and diagrams as well as other information. If you have any suggestions as to how we can improve this installation manual, let us know at <mailto:Suggestions@ATSDiesel.com>.