

BL5 600:5

Split Core Current Transformers

The BL5 Series handles medium to high load while retaining compact size.

Accessible from either sides allow electricians to open/close easily during metering & energy management installations and retrofits without dismantling power-line.

The BL5 Window has a window size of 2.0" X 3.5"

Contact your sales person for further information.



MECHANICAL

Window Size	2.0" x 3.5" [50.8mm x 88.9mm]
Wire Leads	6ft [1.8m] 16AWG blk/wht twisted UL1015 105°C 600V
Operating Temperature	-15°C to 65°C (90% Rel. Hum.)
Altitude	6,600ft [2012m]
Weight	1.7Lbs [0.77Kg]
Keying Hole	Plastic rivet for locking or date tag
Ergonomic	EZ-Open on either sides, no tool

ELECTRICAL

Input (max.)	1000A, AC Sine-wave 50/60Hz
Output	5A, full-scale
Accuracy (typical)	0.5%
Linearity	10% to 120%
Polarity	White (X1 - Hi), Black (X2 - Low)
Phase Direction	Arrow points toward Load
Frequency	40 to 400Hz

REGULATORY STANDARDS

Voltage Rating	600VAC, Category III
Construction	UL94V-0 flame retardant, thermoplastic 2X reinforced insulations, PD2 (optional)
Standards	IEEE C57.13 & IEC 60044-1 UL 61010-1 & CAN/CSA C22.2 IEC 61010-2 & ANSI C12.20

INSTALLATION

For indoor use only. Turn off power source before working with CTs. Observe X1X2 polarity and read manufacturer's instructions of the equipment you are connecting to CTs for proper installation guide. Professional installations required for safe handling and operation.

DIMENSIONS [mm]

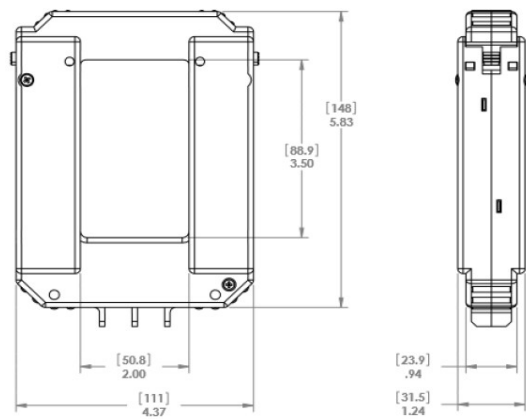

Stock	Model	Ratio	Accuracy	Burden (VA)
1C1417	BL5600RA005	600/5	0.5	2.75