

The “BYRAM” B20

Three Phase Electric Submeter

Three Phase 3 Wire 120-480V 200 Amps

Model# B20-120200D

Features:

- Reliable, Revenue Grade
- UV resistant polycarbonate enclosure
- IP66 sealed case maintains accuracy and prolongs meter life
- Pulse output for Building Automation Systems
- Quick and easy to install
- Kwh, and Demand standard. Options for Time of use, Load profile, and potential for integration into smart metering.



B20-120200D Order Number: 1C7288

The “Byram” B20 Three Phase meter was designed to meet today's most demanding commercial and industrial requirements. The patented digital measurement processor offers high accuracy, repeatability, and low ownership costs.

Revenue Metering

The “Byram” B20 meter is a highly accurate revenue meter (0.2 accuracy Class).

Flexibility and Future Growth

The B20 series has been developed as a walk up and read meter. Meters are programmed for kWh readings (purchase of energy) but have an option for Bi-Directional metering*. Each B20 is furnished with a pulse output compatible with most Building Automation Systems (BAS).

Each B20 meter is capable of being upgraded for remote metering** with additional options of Time of use, and load profile, and interval data.

* The Bi-Directional option is only available at time of order.

** Remote meter reading requires additional hardware and service.



Kit comes with meter and (2) transformers

Specifications

The "Byram" Electric Meter

Maximum voltage	Continuous 528 VAC
Operating Range	120V - 480V
Surge voltage withstand	ANSI C37.90.1 oscillatory 2.5kV, 2500 strikes
	Fast transient 5kV, 2500 strikes
	ANSI C62.41 6kV at 1.2/50 μ s, 10 strikes
	IEC 61000-4-4 4kV, 2.5 kHz repetitive burst for 1 minute
	ANSI C12.16 2.5 kV, 60 Hz for 1 minute
Temperature	-40°F to 122°F (Inside meter cover)
Humidity	0 to 100% RH (Non condensing)
Enclosure	Rugged IP-66 outdoor-rated
Material	UV Resistant Polycarbonate
UL Type	4X/6P Listed
Width x Height x Depth	8.5 in x 7.7 in x 5.5 in
Weight	2.85 lbs.
ANSI Standards	C12.1; C12.10; C13.18; C12.19; C12.20; C12.21

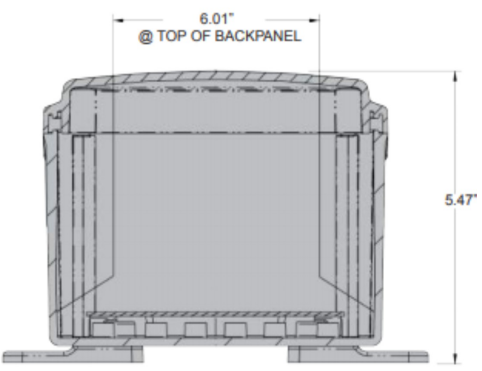
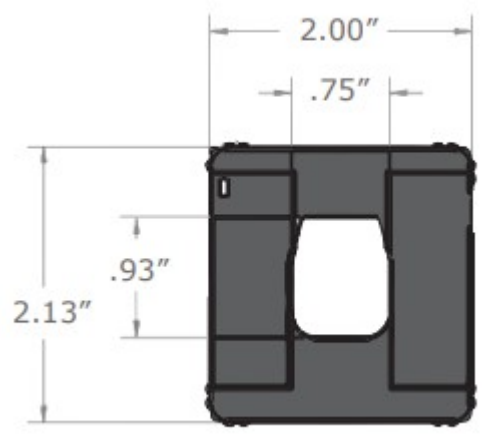
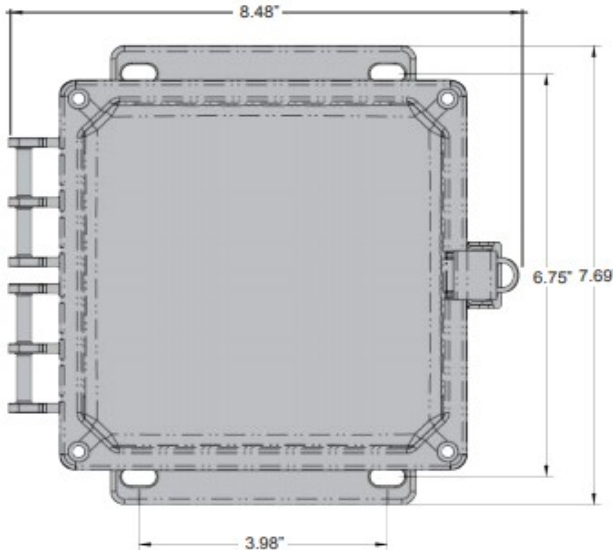

B20-120200D Kit comes with meter and (2) transformers

3 Phase, 3 Wire Installation Diagram

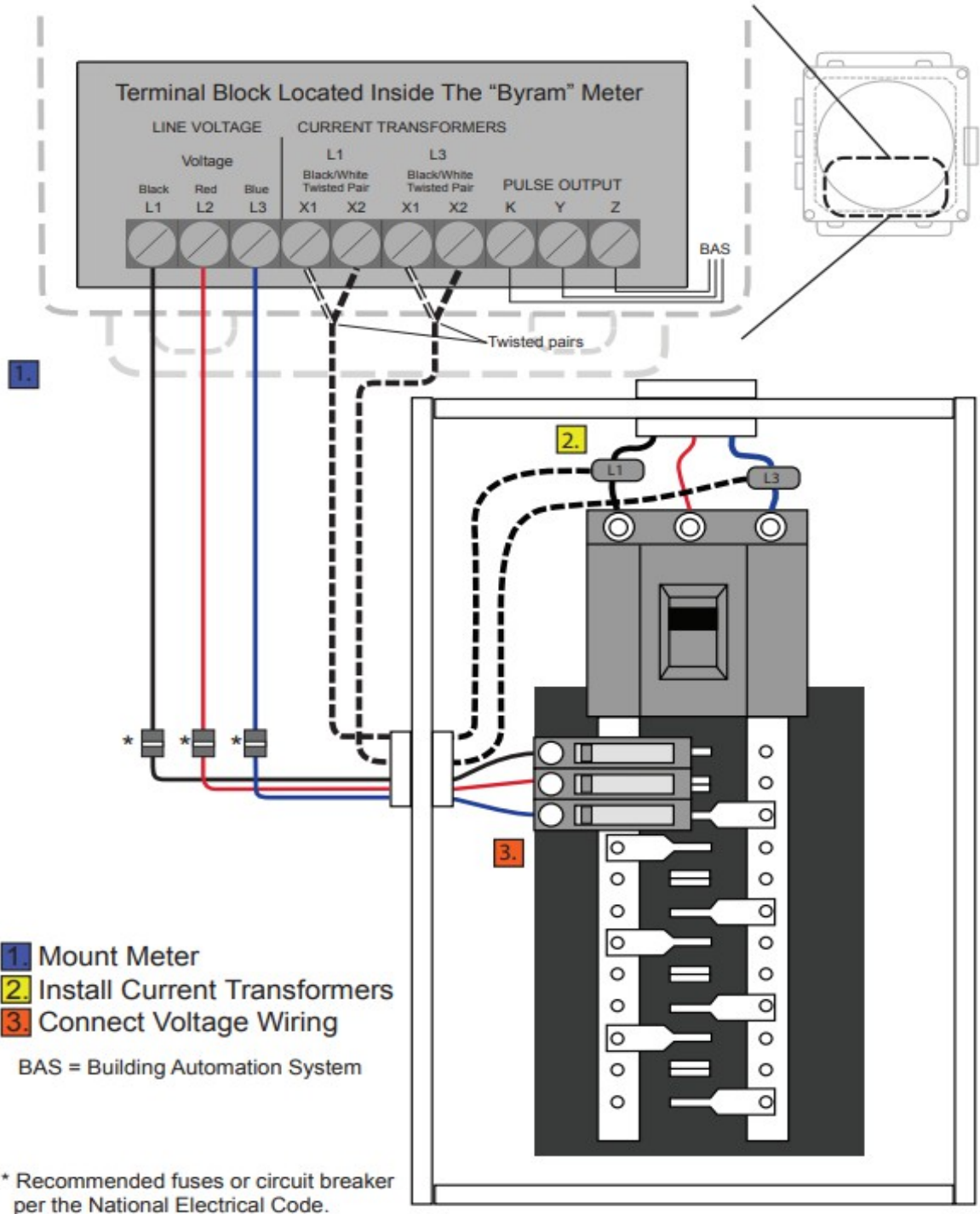

3 Phase Network

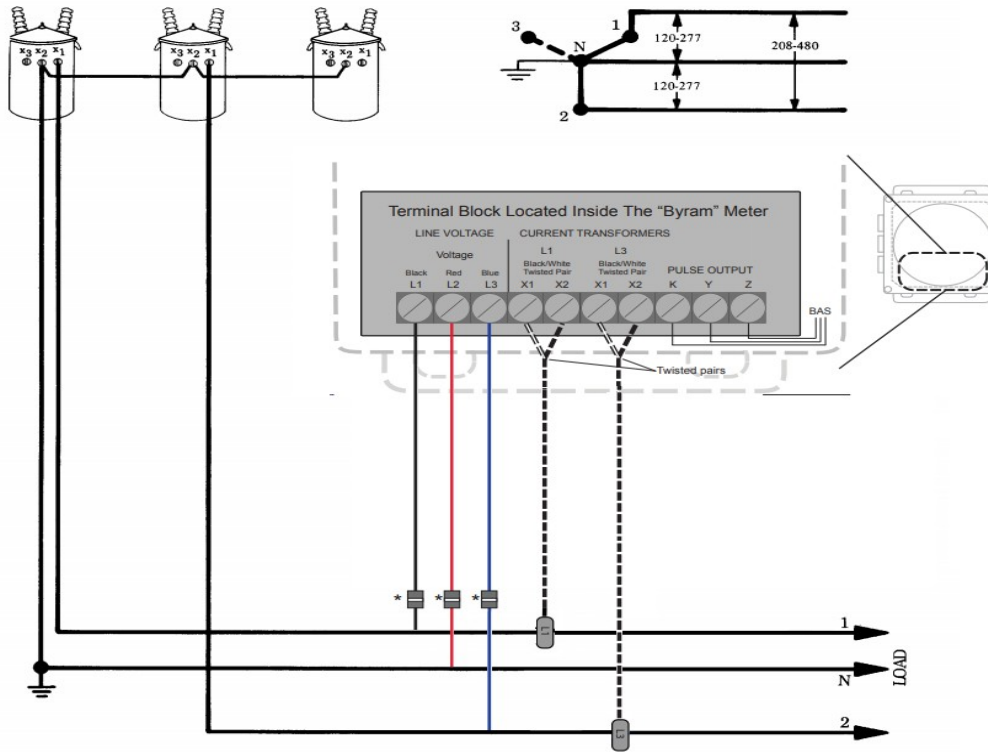

3 Phase 3 Wire

