

The "BYRAM" B10

Single Phase Electric Submeter

Single Phase 3 Wire 208/240V 200 Amps

Model# B10-3208200R

The Byram B10 Single Phase meter was designed to meet today's most demanding residential requirements. The patented digital measurement processor offers high accuracy, repeatability, and low ownership costs.

Revenue Metering

The Byram B10 meter is a highly accurate revenue meter (0.5 accuracy Class).

Flexibility and Future Growth

The B10 series has been developed as a walk up and read meter. Meters are programmed for kWh readings (purchase of energy) but have option for Bi-Directional metering*.

Each B10 meter is capable of being upgraded for remote metering** with additional options of Time of use, and load profile, and interval data.



B10-3208200R Order Number: 1D2336



All Byram meters are shipped with matching transformer(s)

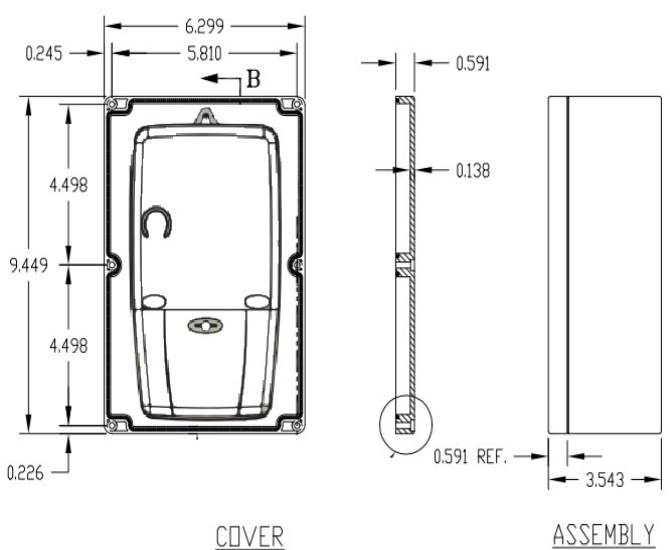

* The Bi-Directional option is only available at time of order.
** Remote meter reading requires additional hardware and service.

Technical specifications

Operating Ranges			
Voltage	Nameplate nominal	Operating	Switch control range*
	120 V	96 V to 144 V	108 V to 144 V
Current	0 to Class ampere rating		
Frequency	Nominal 50 Hz or 60 Hz \pm 5 %		
Temperature	-40 °C to +85 °C (inside meter cover)		
Humidity	0 % to 100 % (noncondensing)		
General performance characteristics			
Starting current		100 mA for Class 200 160 mA for Class 320	
Creep 0.000 A (no current)	No more than 1 pulse measured per quantity, conforming to ANSI C12.1 requirements		
Burden	Less than 1.5 W		
Power supply	Linear power supply conforms to FCC Part 15 Class B device		
Primary time base	Relative time maintained by a crystal; real time is provided by the EnergyAxis network		
Communication frequency	902 MHz to 928 MHz (unlicensed)		

1 Phase, 3 Wire Installation Diagram

