

4-Port Double Gang Stainless Steel Faceplate

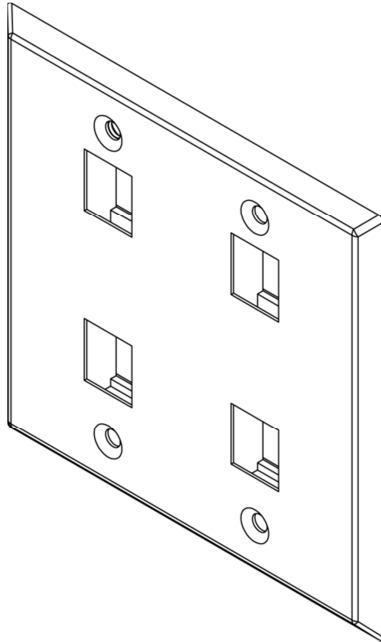

Package Includes:

- A. 4-Port Double Gang Stainless Steel Faceplate, **1 Piece**
- B. #6-32 x 3/4" Oval Head, Countersink, Deep Slotted Drive, Machine Screw, **4 Pieces**

Features and Benefits

- Configured to fit standard double gang outlet box
- Designed to support the distribution of voice, data, and other communication needs to the work area for commercial and residential applications
- Accommodates a wide variety of easy to snap-in modules, providing configuration flexibility
- Accepts all IC107 modules
- ANSI/TIA-568-C and UL 1863 compliant
- Country Of Origin: Taiwan
- TAA Compliant

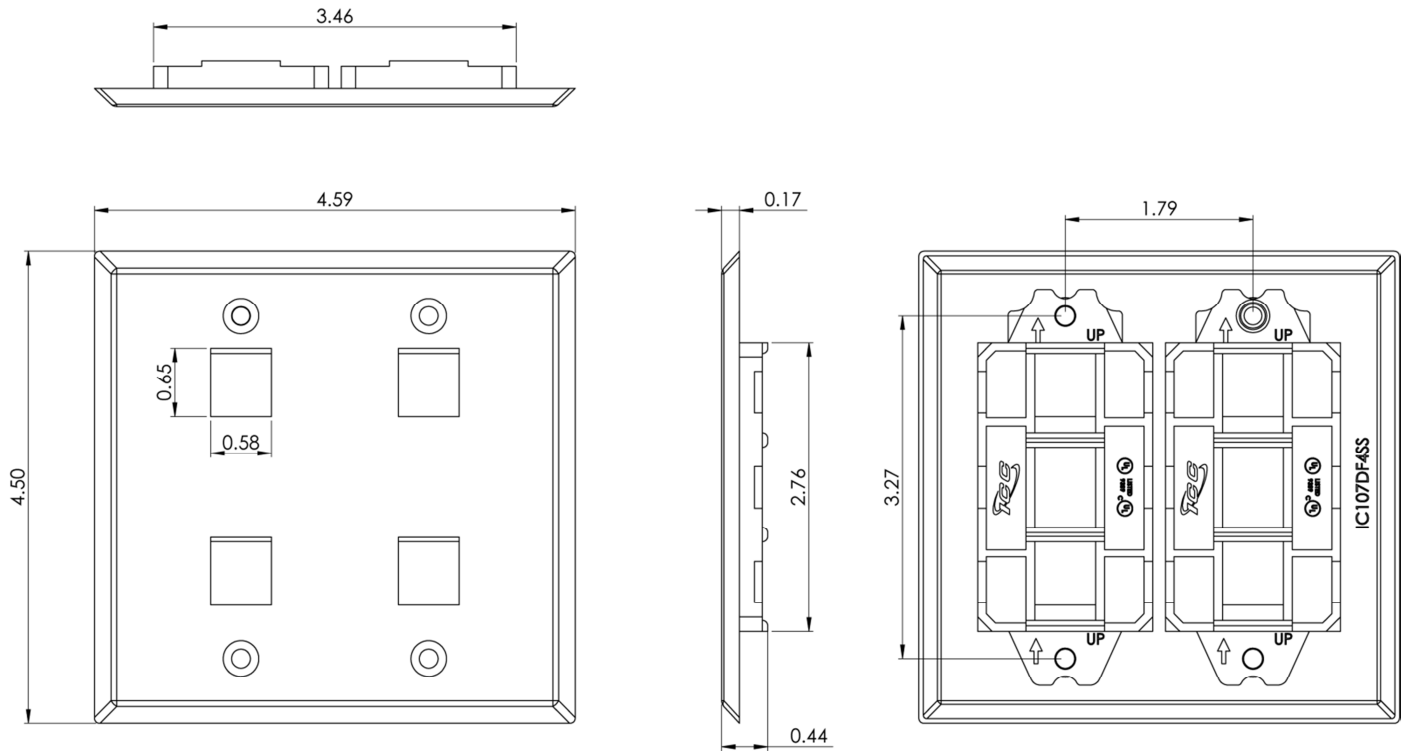

NOTE: UNLESS OTHERWISE SPECIFIED

1. Material:

- A. Faceplate: 22 Gauge, AISI 304 Stainless Steel
- B. Retaining Bracket: ABS, UL 94V-0

2. Surface Finish: #4B

