

# CAT6 UNSHIELDED KEYSTONE JACK (V-MAX Series)



## SKU: 352 SERIES

Height	Width	Depth	Weight (single jack)	Weight (25 Pack)
0.78 in	0.67 in	1.22 in	0.04 lb	0.5 lb

Specifications	
<b>RJ45 Jack</b>	
Housing Material	ABS+PC UL 94V-0
Contact Bracket	PBT+Glass Fiber, UL 94V-0
<b>RJ45 Jack Contact</b>	
Material	Phospor Bronze with Nickel plating
Finish	50 micro-inch Gold plating on Plug contact area
<b>IDC</b>	
Housing	PC UL 94V-0 with Black color
Terminal	Phospor Bronze with Tin plated
Cap	ABS+PC UL 94V-0
PCB	FR4, UL 94V-0
<b>Performance</b>	
Color Code	T568A & T568B wiring
Insertion Force	20N max. (IEC 606037-4)
Retention Strength	17LB (7.7kg) between jack and plug
Operating Temp	-10°C to 60°C max (ISO/IEC 11801, ANSI/TIA 568 C.2)
<b>Operating Life (mating cycles)</b>	
Jack	Minimum 750 cycles min. (ISO/IEC 11801, IEC 60603-7-4)
IDC	Suitable for 23 and 24AWG solid wire
<b>Colors available</b>	
Black, Blue, Gray, Green, Ivory, Yellow, Red, White, Orange, Purple	

## DESCRIPTION

Category 6 V-Max Keystone Jack  
Unshielded - TAA-Compliant  
Lifetime Warranty

## FEATURES

- Color Coded for T568A and T568B standards
- Meets and Exceeds ANSI/TIA-568.2-D, ANSI/TIA 1096-A
- Supports PoE 802.3af, 802.3at, 802.3bt
- Fits most standard keystone wall plates and patch panels
- Narrow connector allows high port density in small areas
- Compatible with standard 110 punch down tool
- Use the V-Max I-Punch Tool for faster termination
- Available in various colors for easy Identification
- UL Listed, RoHS Compliant, TAA Compliant
- 25 pack (single package)

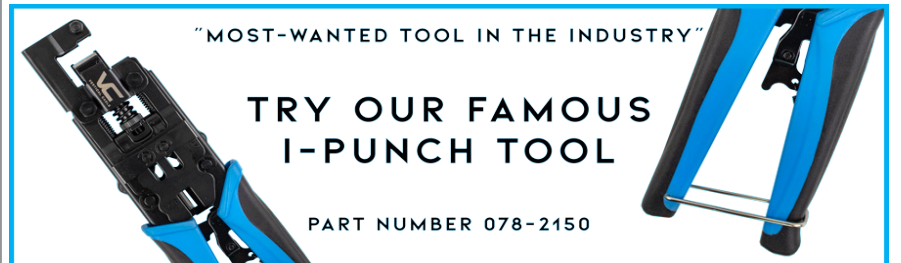
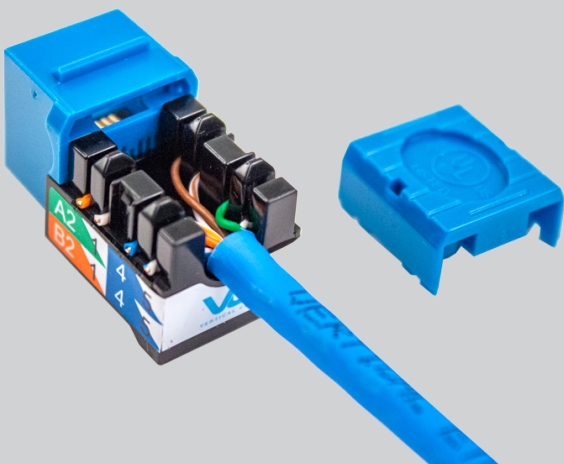

**VERTICAL CABLE**

800.749.2447 Florida  
951.696.7772 California  
845.391.8318 New York



[www.verticalcable.com](http://www.verticalcable.com)

Rev. 07/2020

Specs subject to change without notice.  
It is the sole responsibility of the user to have the most current specs.

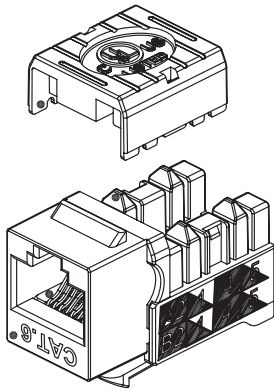

SCALE 1/1

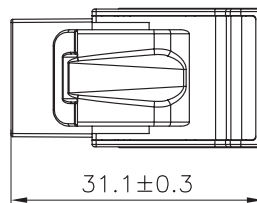
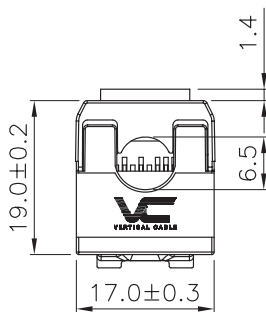
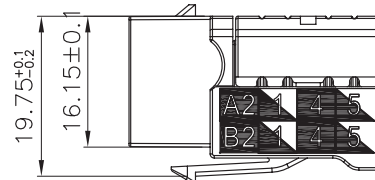
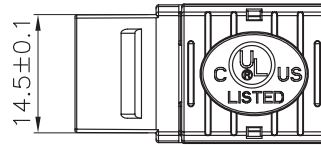
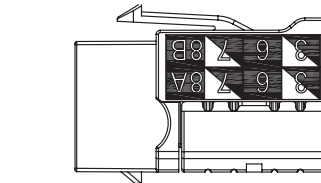
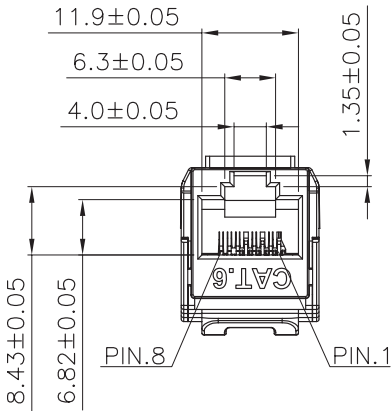
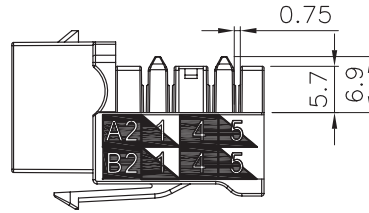
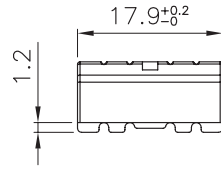

# VERTICAL CABLE

800.749.2447 Florida  
 951.696.7772 California  
 845.391.8318 New York



[www.verticalcable.com](http://www.verticalcable.com)

Rev. 07/2020

Specs subject to change without notice.  
 It is the sole responsibility of the user to have the most current specs.