

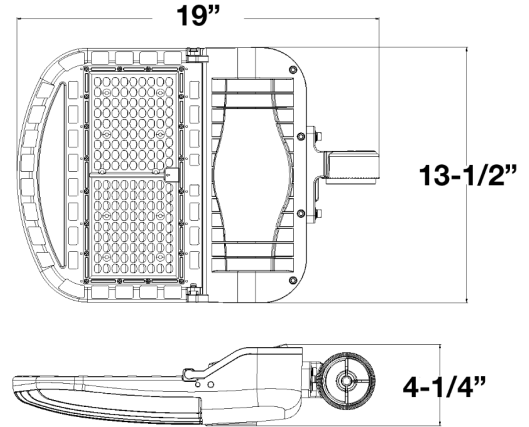

Area Light Gen 3

80W



Features:

- Bronze Diecast Aluminum Housing Heat Resistant Directed Optics
- Frosted Polycarbonate Lens
- Excellent Heat Dissipation
- Maximum Life Expectancy 50,000+ hours
- Seoul 3030 LEDs

Note: Fixture does not include mount - Pole Arm, Slipfitter, Trunnion, Yoke, and Universal Mounts sold separately

Part#	Wattage	Volts	Housing Color	Light Pattern	Lumens	CCT	CRI	Dimming	Lumens/Watt	DLC Product ID# Area Light	DLC Product ID# Flood Light
74079A	80	120-277	Bronze	Type III	10544	5000	75.1	0-10V/PWM/VR	131.8	S-JYZD08	S-RGDWTO
74046A	80	120-277	White	Type III	10544	5000	75.1	0-10V/PWM/VR	131.8	S-L0D8T9	S-U71PQH
74047A	80	120-277	Bronze	Type III	10497	4000	75.1	0-10V/PWM/VR	131.3		PLETGJMFPKA7
74080A	80	120-277	Bronze	Type IV	10592	5000	75.1	0-10V/PWM/VR	132.2	PLLQXITM79MN	
74045A	80	120-277	Bronze	Type V	10491	5000	75.1	0-10V/PWM/VR	131.0		PLZIM4WMSHG1



Area Light Gen 3

80W

Photometrics:

TYPE III:

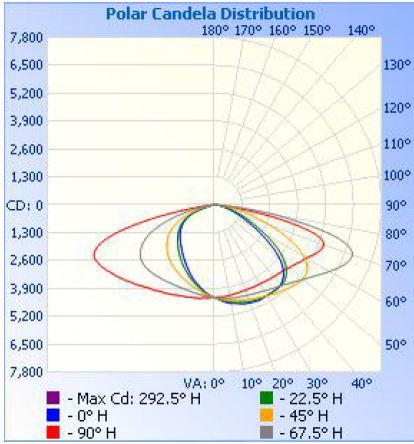

Illuminance at a Distance

	Center Beam fc	Beam Width
17.0ft	8.29 fc	39.8 ft 107.2 ft
34.0ft	2.07 fc	79.6 ft 214.3 ft
51.0ft	0.92 fc	119.3 ft 321.5 ft
68.0ft	0.52 fc	159.1 ft 428.6 ft
85.0ft	0.33 fc	198.9 ft 535.8 ft
102.0ft	0.23 fc	238.7 ft 642.9 ft

Vert. Spread: 99.0°
Horiz. Spread: 144.8°

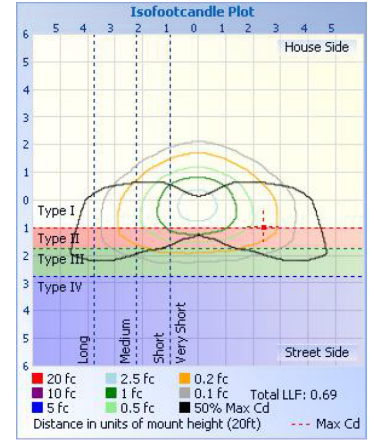

TYPE IV:

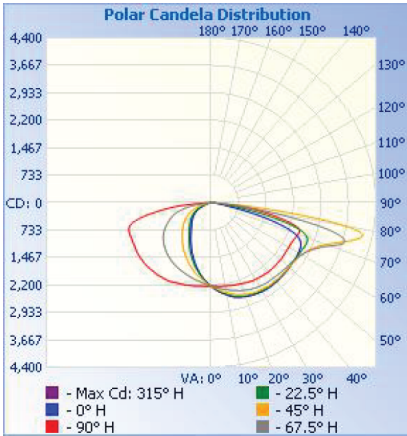

Illuminance at a Distance

	Center Beam fc	Beam Width
17.0ft	7.71 fc	33.9 ft 17.2 ft
34.0ft	1.93 fc	67.8 ft 34.3 ft
51.0ft	0.86 fc	101.7 ft 51.5 ft
68.0ft	0.48 fc	135.6 ft 68.6 ft
85.0ft	0.31 fc	169.5 ft 85.8 ft
102.0ft	0.21 fc	203.4 ft 103.0 ft

Vert. Spread: 89.8°
Horiz. Spread: 53.6°

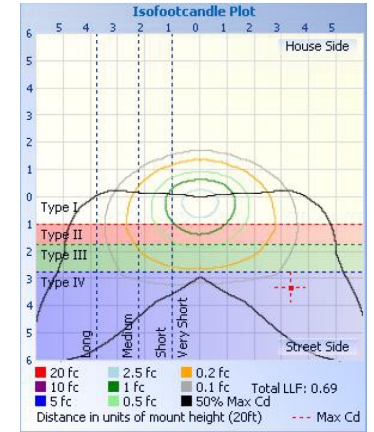

TYPE V:

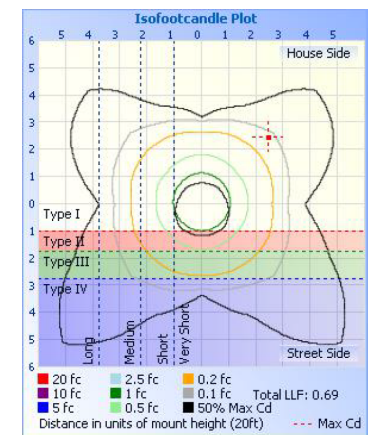
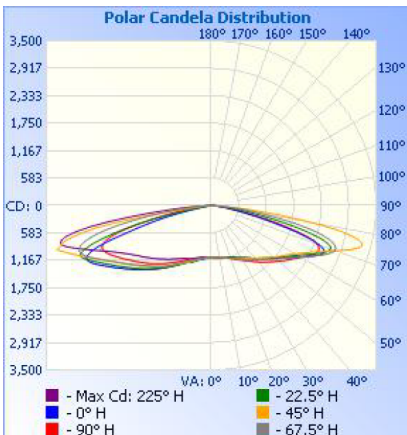



Area Light Gen 3

80W

Additional Technical Specifications:

Voltage	L70	Current	PF	THD	R9	DUV	Chromati city (x,y)	Chromati city (u,v)	Driver Output (Volts)	Driver Output (Amps)	BUG Rating	Surge Protection
120-277	>50k hrs	0.6691-0.3003	0.998-0.945	4.55%-9.98%	0	0.00196	x=0.3904 y=0.3870	u=0.2275 v=0.5075	43V	1.65A	G2	10kV

Component Specification:

LED: Seoul 3030

Operating Temperature:

Minimum Starting -40°F - 122°F

Construction:

Housing: Aluminum Alloy, Powder Coated

IP Rating: IP65 suitable for wet locations

Lens Material: Polycarbonate - Heat, UV and Fire Resistant

Mounting:

2 Pc Mount Design for simple 1 person installation

Photo Control:

Twist lock receptacle and shorting included.

Photocell sold separately.

Listings:

UL Listed: E474299

Carton Qty: 1

Weight: 10.4 lbs.

EPA Rating: 0.8ft²

Warranty:

Morris Products carries a 5 year warranty from date of purchase against defects in materials and workmanship (assuming normal and proper usage).

Accessories:

Pole Arm Mount:

Slipfitter Mount:

Yoke Mount:

Trunnion Mount

Universal Mount:

Motion Sensor with cover:

BRONZE:

Cat# 74032A

Cat# 74034A

Cat# 74036A

Cat# 74038A

Cat# 74043A

Cat# 74072A

WHITE:

Cat# 74033A

Cat# 74035A

Cat# 74037A

Cat# 74039A

Cat# 74044A

Cat# N/A