

Smart choice for power™

xantrex™

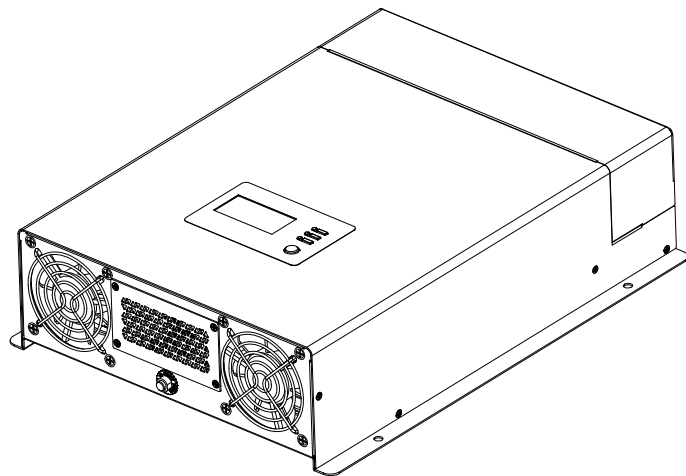

Freedom X Series Inverter

Owner's Guide

Product Part Numbers

817-1000

817-2000

Copyright © 2017 Schneider Electric. All Rights Reserved. All trademarks are owned by Schneider Electric Industries SAS or its affiliated companies.

Exclusion for Documentation

UNLESS SPECIFICALLY AGREED TO IN WRITING, SELLER

(A) MAKES NO WARRANTY AS TO THE ACCURACY, SUFFICIENCY OR SUITABILITY OF ANY TECHNICAL OR OTHER INFORMATION PROVIDED IN ITS MANUALS OR OTHER DOCUMENTATION;

(B) ASSUMES NO RESPONSIBILITY OR LIABILITY FOR LOSSES, DAMAGES, COSTS OR EXPENSES, WHETHER SPECIAL, DIRECT, INDIRECT, CONSEQUENTIAL OR INCIDENTAL, WHICH MIGHT ARISE OUT OF THE USE OF SUCH INFORMATION. THE USE OF ANY SUCH INFORMATION WILL BE ENTIRELY AT THE USER'S RISK; AND

(C) REMINDS YOU THAT IF THIS MANUAL IS IN ANY LANGUAGE OTHER THAN ENGLISH, ALTHOUGH STEPS HAVE BEEN TAKEN TO MAINTAIN THE ACCURACY OF THE TRANSLATION, THE ACCURACY CANNOT BE GUARANTEED. APPROVED CONTENT IS CONTAINED WITH THE ENGLISH LANGUAGE VERSION WHICH IS POSTED AT [HTTP://WWW.XANTREX.COM](http://www.xantrex.com).

Document Part Number

975-0787-01-01

Date and Revision

May 2017 Rev A

Product Part Number

817-1000 (Freedom X 1000 120VAC)

817-2000 (Freedom X 2000 120VAC)

Contact Information

Telephone: +1 800 670 0707
+1 408 987 6030

Email: customerservice@xantrex.com

Web: <http://www.xantrex.com>

Information About Your System

As soon as you open your product, record the following information and be sure to keep your proof of purchase.

Serial Number _____

Product Number _____

Purchased From _____

Purchase Date _____

To view, download, or print the latest revision, visit the website shown under Contact Information.

About This Guide

Purpose

The purpose of this Owner's Guide is to provide explanations and procedures for operating, maintaining, and troubleshooting a Freedom X Series Inverter for Recreational, Fleet Vehicle, or Marine installations.

Scope

The Guide provides safety and operating guidelines as well as information on installing and configuring the Inverter. It also provides information about troubleshooting the unit. It does not provide details about particular brands of batteries. You need to consult individual battery manufacturers for this information.

Audience

The Guide is intended for users and operators as well as installers of the Freedom X Series Inverter.

Abbreviation or Acronym

A	Amps
AC	Alternating Current
DC	Direct Current
in-lbf	inch-pounds or pound-force (a unit of torque)
kW	Kilowatts (1000 watts)
LBCO	Low Battery Cutout (or Cutoff)
LED	Light Emitting Diode
N-m	Newton-meters (a unit of torque)

PV	Photovoltaic (Solar)
V	Volts
VAC	Volts AC
VDC	Volts DC
W	Watts

Related Information

You can find more information about Xantrex products and services at <http://www.xantrex.com>.

NOTE: The Installation section starting on page 9 is intended for qualified personnel. Qualified personnel have training, knowledge, and experience in:

- Installing electrical equipment (up to 1000 volts).
- Applying all applicable installation codes.
- Analyzing and reducing the hazards involved in performing electrical work.
- Selecting and using Personal Protective Equipment (PPE).

Important Safety Instructions

IMPORTANT: READ AND SAVE THIS OWNER'S GUIDE FOR FUTURE REFERENCE.

This guide contains important safety instructions for the Freedom X Series Inverter that must be followed during operation and troubleshooting. **Read and keep this Owner's Guide for future reference.**

Read these instructions carefully and look at the equipment to become familiar with the device before trying to install, operate, service or maintain it. The following special messages may appear throughout this bulletin or on the equipment to warn of potential hazards or to call attention to information that clarifies or simplifies a procedure.



The addition of either symbol to a "Danger" or "Warning" safety label indicates that an electrical hazard exists which will result in personal injury if the instructions are not followed.



This is the safety alert symbol. It is used to alert you to potential personal injury hazards. Obey all safety messages that follow this symbol to avoid possible injury or death.

DANGER

DANGER indicates an imminently hazardous situation, which, if not avoided, will result in death or serious injury.

WARNING

WARNING indicates a potentially hazardous situation, which, if not avoided, can result in death or serious injury.

CAUTION

CAUTION indicates a potentially hazardous situation, which, if not avoided, can result in moderate or minor injury.

NOTICE

NOTICE indicates a potentially hazardous situation, which, if not avoided, can result in equipment damage.

Important: These notes describe things which are important for you to know, however, they are not as serious as a caution or warning.

Safety Information

1. **Before using the Inverter, read all instructions and cautionary markings on the unit, the batteries, and all appropriate sections of this manual.**
2. Use of accessories not recommended or sold by the manufacturer may result in a risk of fire, electric shock, or injury to persons.
3. The inverter is designed to be connected to your AC and DC electrical systems. The manufacturer recommends that all wiring be done by a certified technician or electrician to ensure adherence to the local and national electrical codes applicable in your jurisdiction.
4. To avoid a risk of fire and electric shock, make sure that existing wiring is in good condition and that wire is not undersized. Do not operate the inverter with damaged or substandard wiring.
5. Do not operate the inverter if it has been damaged in any way.
6. This unit does not have any user-serviceable parts. Do not disassemble the inverter except where noted for connecting wiring and cabling. See your warranty for instructions on obtaining service. Attempting to service the unit yourself may result in a risk of electrical shock or fire. Internal capacitors remain charged after all power is disconnected.
7. To reduce the risk of electrical shock, disconnect both AC and DC power from the inverter before attempting any maintenance or cleaning or working on any components connected to the inverter. Turning off the Inverter using the Power button on the front panel will not reduce an electrical shock hazard.
8. The inverter must be provided with an equipment-grounding conductor connected to the AC input ground.
9. Do not expose this unit to rain, snow, or liquids of any type. This product is designed for indoor use only. Damp environments will significantly shorten the life of this product and corrosion caused by dampness will not be covered by the product warranty.
10. To reduce the chance of short-circuits, always use insulated tools when installing or working with this equipment.
11. Remove personal metal items such as rings, bracelets, necklaces, and watches when working with electrical equipment.

DANGER

ELECTRICAL SHOCK AND FIRE HAZARD

Installation must be done by qualified personnel to ensure compliance with all applicable installation and electrical codes and regulations. Instructions for installing the Freedom X Series Inverter are provided here for use by qualified personnel only.

Failure to follow these instructions will result in death or serious injury.

 **DANGER**

HAZARD OF ELECTRIC SHOCK, EXPLOSION, OR ARC FLASH

- Apply appropriate personal protective equipment (PPE) and follow safe electrical work practices. See NFPA 70E or CSA Z462.
- This equipment must only be installed and serviced by qualified electrical personnel.
- Turn off all power supplying this equipment before working on or inside equipment.
- Always use a properly rated voltage sensing device to confirm power is off.
- Replace all devices, doors, and covers before turning on power to this equipment.

Failure to follow these instructions will result in death or serious injury.

 **WARNING**

FIRE AND EXPLOSION HAZARD

- Unit's components may produce arcs or sparks.
- Do not install near batteries, in machinery space, or in an area in which ignition-protected equipment is required.

Failure to follow these instructions can result in death or serious injury.

Areas include any space containing gasoline-powered machinery, fuel tanks, as well as joints, fittings, or other connections between components of the fuel system.

⚠ CAUTION

ELECTRICAL SHOCK AND FIRE HAZARD

- Do not open. No serviceable parts inside. Provided with integral protection against overloads. Bonding between conduit connections is not automatic and must be provided as part of the installation.
- Read manual before installing or using.
- Do not cover or obstruct ventilation openings.
- Do not mount in zero-clearance compartment – overheating may result.
- Do not expose to rain or spray. This inverter is designed for marine applications only when additional drip protection is installed in certain orientations. See “Approved Mounting Orientations” on the Installation Guide for more information.
- Install GFCIs only as specified in this manual. Other types may fail to operate.
- Do not connect AC OUT to any other source of power. Damage to unit may occur.
- For AC IN and AC OUT, use wires suitable for at least 75°C.

Failure to follow these instructions can result in minor or moderate injury.

NOTES:

1. Follow these instructions and those published by the battery manufacturer and the manufacturer of any equipment you intend to use in the vicinity of the battery. Review cautionary markings on these products and on the engine.

2. Freedom X inverter products are designed for deep cycle lead-acid batteries. See warning below when connecting to lithium ion batteries.
3. Do not use transformerless battery chargers in conjunction with the inverter due to overheating.

⚠ WARNING

LITHIUM_ION BATTERY TYPE HAZARD

Make sure to use a lithium ion battery pack that includes a Battery Management System (BMS) with built-in safety protocols. Follow the instructions published by the battery manufacturer.

Failure to follow these instructions can result in property damage, death or serious injury.

⚠ CAUTION

PHYSICAL INJURY HAZARD

This Freedom X Series Inverter is not intended for use by persons (including children) with reduced physical, sensory, or mental capabilities or lack of experience and knowledge, unless they have been given supervision or instruction concerning use of the appliance by a person responsible for their safety. Children should be supervised to ensure that they do not play with the appliance.

Failure to follow these instructions can result in minor or moderate injury.

Precautions When Working With Batteries

Important: Battery work and maintenance must be done by qualified personnel knowledgeable about batteries to ensure compliance with battery handling and maintenance safety precautions.

WARNING

BURN FROM HIGH SHORT-CIRCUIT CURRENT, FIRE AND EXPLOSION FROM VENTED GASES HAZARDS

- Always wear proper, non-absorbent gloves, complete eye protection, and clothing protection. Avoid touching your eyes and wiping your forehead while working near batteries. See note #4.
- Remove all personal metal items, like rings, bracelets, and watches when working with batteries. See notes #5 and #6 below.
- Never smoke or allow a spark or flame near the engine or batteries.

Failure to follow these instructions can result in death or serious injury.

NOTES:

1. Mount and place the Freedom X Series Inverter unit away from batteries in a well ventilated compartment.
2. Always have someone within range of your voice or close enough to come to your aid when you work near a lead-acid battery.
3. Always have plenty of fresh water and soap nearby in case battery acid contacts skin, clothing, or eyes.
4. If battery acid contacts skin or clothing, wash immediately with soap and water. If acid enters your eye, immediately flood it with running cold water for at least twenty minutes and have someone within range of your voice or close enough to get medical attention immediately.

5. Use extra caution to reduce the risk of dropping a metal tool on the battery. It could spark or short circuit the battery or other electrical parts and could cause an explosion. Use tools with insulated handles only.
6. Batteries can produce a short circuit current high enough to weld a ring or metal bracelet or the like to the battery terminal, causing a severe burn.
7. When removing a battery, always remove the negative terminal from the battery first for systems with grounded negative. If it is grounded positive, remove the positive terminal first. Make sure all loads connected to the battery and all accessories are off so you don't cause an arc.

Precautions When Placing the Inverter

WARNING

FIRE HAZARD

Do not install the inverter or any part of its supplied wiring in engine compartments.

Failure to follow these instructions can result in death or serious injury.

CAUTION

BURN HAZARD

Avoid touching the external surfaces - heatsink may be hot.

Failure to follow these instructions can result in minor or moderate injury.

NOTICE

RISK OF DAMAGE TO THE INVERTER

- Never allow battery acid to drip on the inverter when reading gravity, or filling battery.
- Never place the Freedom X Series Inverter unit directly above batteries; gases from a battery will corrode and damage the inverter.
- Do not place a battery on top of the inverter.

Failure to follow these instructions can damage the unit and/or equipment.

Regulatory

The Freedom X Series Inverter is certified to appropriate US and Canadian standards. For more information see “Regulatory Approvals” on page 67.

The Freedom X Series Inverter is intended to be used for mobile or commercial applications. This Inverter is designed for marine applications only when additional drip protection is installed in certain orientations. See the section on Specifications for information.

FCC Information to the User

This equipment has been tested and found to comply with the limits for a Class B digital device, pursuant to part 15 of the FCC Rules. These limits are designed to provide reasonable protection against harmful interference in a residential installation. This equipment generates, uses, and can radiate radio frequency energy and, if not installed and used in accordance with the instructions, may cause harmful interference to radio communications.

However, there is no guarantee that interference will not occur in a particular installation. If this equipment does cause harmful interference to radio or television reception, which can be determined by turning the equipment off and on, the user is encouraged to try to correct the interference by one or more of the following measures:

- Reorient or relocate the receiving antenna.
- Increase the separation between the equipment and receiver.
- Connect the equipment into an outlet on a circuit different from that to which the receiver is connected.
- Consult the dealer or an experienced radio/TV technician for help.

 CAUTION
Unauthorized changes or modifications to the equipment could void the user's authority to operate the equipment.

Contents

Important Safety Instructions	iii
Introduction	1
Features	4
Safety Instructions	9
Installation Tools and Materials	10
Basic Installation Procedures	11
Marine Installation	35
Inverter Operation	39
Viewing Information During Battery Mode	42
Viewing Information During Grid Mode	43
Adjusting Feature Settings in Configuration Mode	44
Operating in Battery Mode	49
Operating During Transition Between Grid Mode and Battery Mode	52
Troubleshooting	57
Warning Messages	58
Troubleshooting Reference	60
Inverter Applications	64
Specifications	65

Introduction

The Freedom X Series Inverter (Freedom X) is designed with integrated inverting functions and power management features suitable for marine, recreational, and commercial vehicle installations.

Please read this chapter to familiarize yourself with the main performance and protection features of the Freedom X.

Materials List

The Freedom X base package includes the following items:

- one Freedom X unit
- one Owner's Guide and extra safety labels
- one pre-installed ground lug (not shown)
- one set of plastic bushings for large DC cables^a (not shown)

NOTE: If any of the items are missing, contact Xantrex or any authorized Xantrex dealer for replacement. See "Contact Information" on page i.

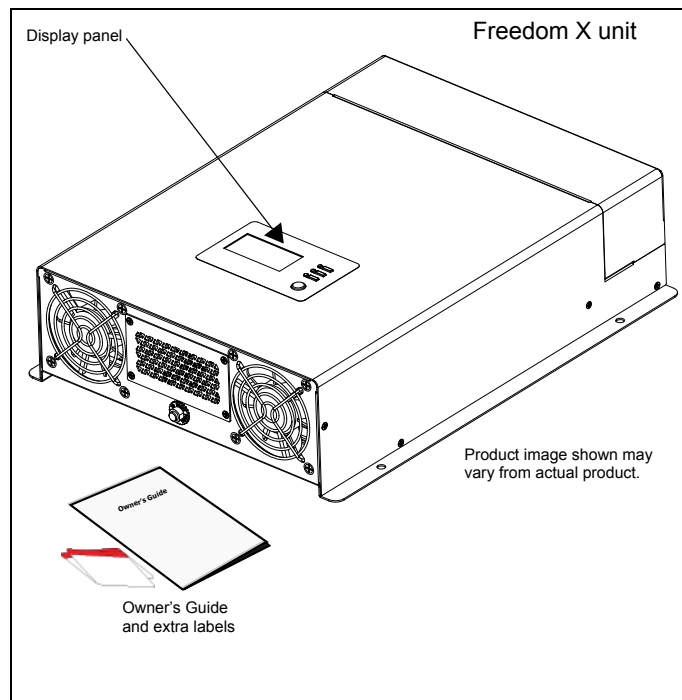

Figure 1 What's In The Box

^a. Available only to X 2000 model.

Key Features

Power for Most Appliances The Freedom X inverter provides up to 1000 watts (Freedom X 1000) or 2000 watts (Freedom X 2000) of continuous utility grade, sine wave power derived from a battery bank. It is designed to handle loads such as microwave ovens, TVs, DVD/Blu-ray players, and power tools. In addition, the Freedom X's high-surge capability lets you handle many hard-to-start loads, including full size residential refrigerators.

The built-in transfer switch automatically transfers between inverter power and shore power from recreational facilities such as boat docks or campsites to ensure power is always available.

Back-up Capability If incoming shore power is interrupted by external events like brownouts, the Freedom X automatically becomes an independent power source^a that supplies utility grade AC power to your loads.

Comprehensive Protection The Freedom X's built-in protection features safeguard your batteries (from unnecessary drain) such as the low battery voltage alarm and shutdown and protect equipment such as a configurable AC transfer speed.

- **Selectable Low Battery Shutdown:** The low battery shutdown for the inverter can be manually selected by the user from 10.5 to 12.8 VDC.

- **Low Voltage Shutdown Delay Timer:** Configurable from 1 to 300 seconds to reduce an unnecessary shutdown of inverter operation such as during cranking or other brief but heavy discharge of battery.
- **Inverter Power Save:** The Freedom X can be programmed to automatically turn off after 1 to 25 hours of continued operation of loads that are under 50 watts. It is designed, with LBCO (low battery cut off), to prevent the battery from deep discharge.

Configurable AC Transfer Speed The Freedom X allows two speed settings for the AC transfer from Grid Mode to Battery Mode and vice versa which avoids nuisance resetting of appliances. The normal transfer rate is for common appliances and the faster transfer rate is designed for more sensitive digital equipment like a desktop computer.

Overload Alarm and Shutdown During Battery Mode (also called Inverter Mode), the Freedom X automatically alerts you if the loads that are connected and drawing power from the unit are close to approaching the maximum operating limit. If so, the Freedom X automatically shuts down when the maximum operating limit is exceeded. See page 60 for precautions.

a. Assuming the inverter is connected to a battery source with an adequate charge at the time of the power interruption.

Over temperature Alarm and Shutdown During Battery Mode, the Freedom X automatically alerts you if it is overheating and approaching the over-temperature shutdown limit. The Freedom X automatically shuts down when the limit is exceeded. See page 60 for precautions.

Ignition Control The Freedom X provides two user-selectable options for ignition control:

- **Ignition Auto-on:** The Freedom X can automatically turn the inverter on and off in tandem with the vehicle's ignition circuit or a manually operated remote switch.
- **Ignition Lockout:** The Freedom X features the ability to inhibit the inverter from operating in the absence of a voltage signal from a vehicle's ignition circuit. This is particularly useful if the inverter is required to operate only when a vehicle's engine is running.

Configurable AC Output Frequency and Voltage The Freedom X is factory set to 60 Hz AC output frequency and 120 VAC. It can be configured to 50 Hz for use in regions outside the USA and Canada. The AC voltage setting can also be configured to either of three settings: 120, 110, or 108 volts.

Features

AC and DC Panel

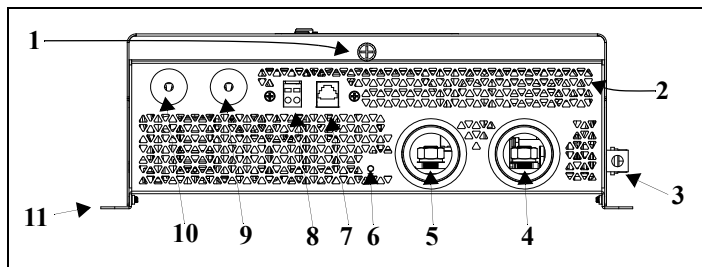

Feature	Description
1	Captive nut panel screw holds the AC compartment cover in place.
2	Ventilation grille (openings) must not be obstructed.
3	Grounding stud with attached nut provides a ground path for the Freedom X chassis to the DC system ground.
4	DC output opening for routing (-) negative DC cable.
5	DC output opening for routing (+) positive DC cable.
6	LED indicator for reverse DC polarity.

Feature	Description
7	Remote port allows you to connect an accessory remote control device.
8	ACC input terminal for connecting ignition control wiring. Ignition Control Switch (ACC) for connecting [ON (I)] and disconnecting [OFF (O)] the ignition signal.
9	AC output knockout can be removed for routing AC output wiring.
10	AC input knockout can be removed for routing AC input wiring.
11	Mounting flanges on both sides allow you to mount the inverter permanently on deck or on a wall.

GFCI Panel

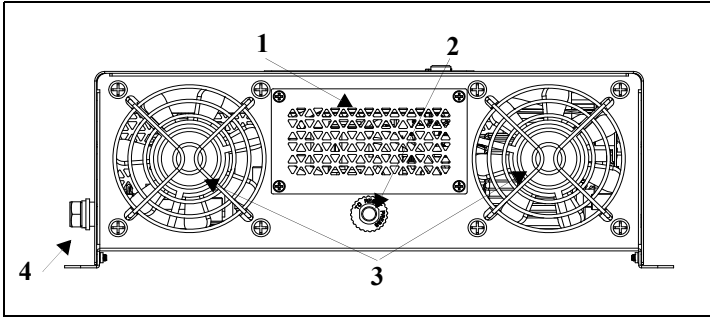

Feature	Description
1	GFCI cover is removed when installing a GFCI outlet. Location of GFCI receptacles.
2	20 A supplementary protector with reset button provides overload protection for the Freedom X GFCI Device (PN: 808-9817). Press to recover from an overload condition. In a hard wired installation, the supplementary protector does not protect output wiring.
3	Ventilation grille (openings) must not be obstructed for the proper operation of the cooling fan and inverter. When the inverter is mounted, the ventilation grille must not point up or down. Cooling fans turn on when the internal temperature reaches a set point temperature.
4	Grounding lug provides a ground path for the Freedom X chassis to the DC system ground.

Display Panel

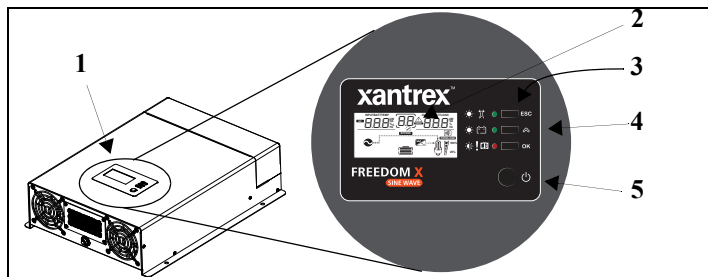

Feature	Description
1	Display panel displays status information on the screen. It is comprised of a display screen, LEDs, function and power buttons.
2	Multi-function LCD screen shows status information and error codes.
3	Status LEDs indicate the mode of operation.
4	Three function buttons change status information displayed on the screen. Also, changes inverter settings.
5	Power button is pressed for turning on the unit. The inverter turns on for the loads.
IMPORTANT: See “Freedom X Display Panel” on page 39 for detailed information on the panel’s buttons.	

Side Panel

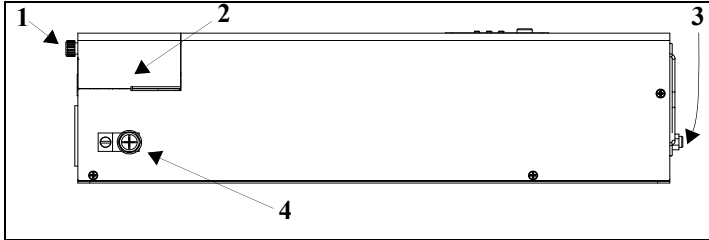

Feature	Description
1	Captive nut panel screw holds the wiring compartment cover in place.
2	Wiring compartment cover protects the wiring compartment from debris and keeps the cables secure. Using the captive nut panel screw, the cover can be opened and lifted out during wiring.
3	20 A supplementary protector provides overload protection for the GFCI receptacles. In a hard wired installation, the supplementary protector does not protect output wiring.
4	Grounding lug provides a ground path for the Freedom X chassis to the DC system ground.

Safety Instructions

Before You Begin the Installation

Before beginning your installation:

- Read this entire Installation section so you can plan the installation from beginning to end.
- Assemble all the tools and materials you require for the installation.
- Review the Important Safety Instructions on page iii.
- Be aware of all safety and electrical codes which must be met.

WARNING

ELECTRICAL SHOCK AND FIRE HAZARD

- All wiring should be done by qualified personnel to ensure compliance with all applicable installation codes and regulations.
- Disconnect all AC and DC power sources.
- Disable and secure all AC and DC disconnect devices and automatic generator starting devices.

Failure to follow these instructions can result in death or serious injury.

Installation Codes

Governing installation codes vary depending on the specific location and application of the installation. Some examples include the following:

- The U.S. National Electrical Code (NEC)
- The Canadian Electrical Code (CEC)
- The U.S. Code of Federal Regulations (CFRs)
- Canadian Standards Association (CSA) and the RV Industry Association (RVIA) for installations in RVs
- The American Boat and Yacht Council (ABYC) for Marine installations in the U.S.

It is the installer's responsibility to ensure that all applicable installation requirements are met.

This section for use by qualified personnel only.

Installation Tools and Materials

You will need the following to install the Freedom X:

- Wire stripper
- Mounting (#2) screws or bolts
- #2 Phillips screwdriver
- 3mm slot long neck screwdriver for spring clamp AC terminals
- Wrench for DC terminals ($\frac{1}{2}$ " or 13mm socket wrench)
- AC cable (that is, two-conductor-plus-ground cable), sized appropriately for load and application
- $\frac{1}{2}$ " Strain relief clamps (for the AC knockouts)
- Wire nuts or crimp connectors for AC wire and appropriate tools
- DC cable, sized appropriately for load and application
- Lugs for DC cables to fit $\frac{5}{16}$ " DC stud terminals as well as appropriate tools (like a crimping tool)
- AC and DC disconnects and over-current protective devices

Basic Installation Procedures

This section provides sample installation information as a guide for your installation. For your convenience, the overall procedure is divided into these main steps:

- ❑ Step 1: Designing the Installation on page 12
- ❑ Step 2: Choosing a Location for the Unit on page 17
- ❑ Step 3: Mounting the Unit on page 18
- ❑ Step 4: Connecting the AC Input Wires on page 20
- ❑ Step 5: Connecting AC Output to an Existing AC Circuit on page 24
- ❑ Step 6: Connecting the DC Cables on page 26
- ❑ Step 7: Connecting to a Remote Panel on page 32
- ❑ Step 8: Testing Your Installation on page 33

This section for use by qualified personnel only.

Step 1: Designing the Installation

Most Freedom X installations share common components, and some of these are briefly described in Figure 1.

Figure 1 shows some components and their relationship to each other in a typical recreational vehicle or fleet vehicle installation. Also, see “Marine Installation” on page 35.

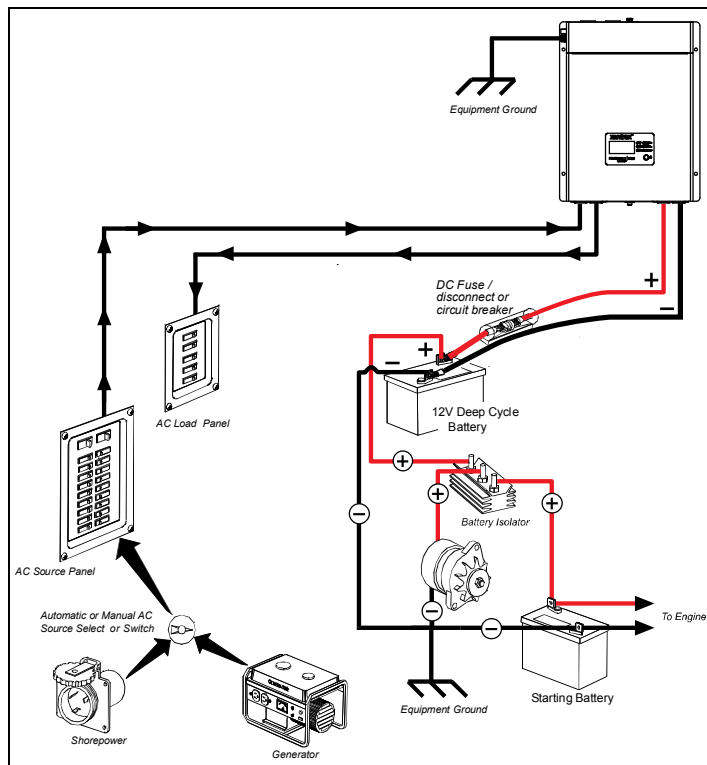

Figure 1 Typical Recreational Vehicle and Fleet Vehicle Installation

AC Shore Power

A source of 120 volts AC 60Hz sine wave alternating current provides energy to pass power through to AC loads. This source is usually the utility grid (power company) or an AC generator. An automatic or manual AC source selector switch can be used to switch between the multiple sources of shore power to the Freedom X system.

The AC source feeding the Freedom X must have the neutral conductor bonded to ground. When the inverter passes shore power through, it will lift its internal bonding relay on the output and will rely on the input being bonded in order to ensure that the power delivered to a sub panel is properly bonded. See “AC Output Neutral Bonding” on page 15 for more information on bonding relay operation.

Important: Throughout this manual, the term “shore power” refers to AC input power from a utility grid, generator, or other AC source.

AC Disconnect and Over-Current Protection Device

Most safety requirements and electrical codes require the Freedom X’s AC and DC inputs and outputs to be provided with over-current protection (such as circuit breakers or fuses) and disconnect devices.

AC Input: The circuit breaker or fuse (connected through hard wiring) that is used to supply the Freedom X must be rated at no more than 30A and must be approved for use on 120 volts AC branch circuits. The wire used between the breaker and the Freedom

X input must be sized adequately to carry current up to the rating of the input breaker and in accordance with the electrical codes or regulations applicable to your installation.

AC Output: The circuit breaker or fuse must be rated at no more than the rating of the input breaker in the installation and must be approved for use on 120 volts AC branch circuits. The wire used between the Freedom X and the AC output breaker must be of adequate size to match the AC input circuit breaker’s rating. The wiring from each AC output breaker to each of the loads must be adequately sized to carry the current rating of the individual AC output breaker.

Disconnect Devices: Each system requires a method of disconnecting the AC circuits. If the over-current protection devices are circuit breakers, they will also serve as the disconnects. If fuses are used, separate AC disconnect switches will be needed ahead of the fuses. These will have to be a branch circuit rated for 120 volts AC and have an appropriate current rating.

This section for use by qualified personnel only.

AC Distribution Panels

Most systems incorporate distribution centers both ahead of the Freedom X (the AC source panel) and between the Freedom X and the loads (the AC load panel). An AC source panel includes a main circuit breaker, which serves as over-current protection and as a disconnect for the AC shore power supply line. Additional circuit breakers serve individual circuits, one of which serves the Freedom X. The AC load panel can incorporate an AC output circuit breaker and breakers for individual load circuits.

NOTICE

RISK OF DAMAGE TO THE INVERTER

Do not connect the Freedom X to a 120/240V, 3-pole, 4-wire circuit.

Failure to follow these instructions can damage the unit and/or equipment.

AC Cabling

AC cabling includes all the wires and connectors between the AC source and the Freedom X, as well as all cabling between the Freedom X and the AC output panels, circuit breakers, and loads. The type and size of the wiring varies with the installation and load. For example, in high vibration environments, such as marine or RV applications, wire nuts may not be acceptable, so crimp splices would be required. In other applications, flexible multiple-strand wire may be required. Installation codes usually specify solid or stranded, overall size of the conductors, and type and temperature rating of the insulation around the wire.

AC breakers and fuses must be sized to adequately protect the wiring that is installed on the input and output AC circuits of the Freedom X. All breakers and wiring must be sized and connected in accordance with the electrical codes or regulations applicable to your installation. Table 1 gives some examples of wiring sizes based on the U.S. National Electrical Code and the Canadian Electrical Code. These examples are based on using a two-conductor-plus-ground cable rated at 75 °C, and assuming an ambient temperature of up to 30 °C. Ensure that your breakers and fuses have suitable temperature ratings for your wiring. Other codes and regulations may also be applicable to your installation.

Table 1 Required AC Wire Size vs Breaker Rating

Breaker Size (amps)	10A	15A	20A	30A
Minimum Wire Size	14AWG	14AWG	12AWG	10AWG

AC Output Neutral Bonding

The neutral conductor of the Freedom X's AC output circuit (that is, AC Output Neutral) is automatically connected to the safety ground during inverter operation. When AC utility power is present this connection is not present, so that the utility neutral (that is, AC Input Neutral) is only connected to utility ground at your source. This conforms to the National Electrical Code (NEC), which requires that separately derived AC sources (such as inverters and generators) have their neutral conductors tied to ground in the same way that the neutral conductor from the utility is tied to ground in only one place. Check the regulations for your specific application to ensure that the installation will comply with the necessary requirements. In other words, the AC Input Neutral and Output Neutral must be isolated from each other.

AC Grounding

As per UL458 SA29.5, for all permanently connected marine inverters: The Freedom X should be connected to a grounded, metal, permanent wiring system. Also, make sure that an AC ground wire is connected to the AC ground terminal on the unit. Do not just connect the line and neutral wires.

All connections to the unit should comply with all local codes and ordinances.

DC Cabling

This includes all the cables and connectors between the batteries, the DC disconnect and over-current protection device, and the Freedom X. Most mobile installations require multi-strand insulated cables for flexibility and durability in high vibration environments and require disconnects and over-current devices. Electrical wiring sizes in North America are indicated by AWG notation. In other parts of the world, the metric system is used. Under the AWG standard, a larger gauge number indicates a smaller wire diameter. Wire size is usually marked on the larger sized cables. Table 2 specifies the minimum recommended DC cable size and maximum fuse size for the Freedom X. **The DC cables must be copper and must be rated 75 °C minimum.** The cables should be terminated with lugs that fit the DC stud terminals snugly ($\frac{3}{16}$ " hole size).

Table 2 Recommended Cable and Fuse Sizes

Inverter	Cable Length: Battery to Inverter (one way)	Minimum Cable Size	Maximum battery Fuse Size
Freedom X 1000 120VAC	Less than 5 feet (1.5 meters)	No. 2 AWG	150 A DC
Freedom X 2000 120VAC	Less than 5 feet (1.5 meters)	No. 2/0 AWG	250 A DC

NOTE: It is not recommended using a cable longer than 5 feet (1.5 meters) in each direction. North American cable sizes above are based on the US National Electrical Code Table 310.17 - 75 °C cables, assuming an ambient temperature of 30 °C cables.

This section for use by qualified personnel only.

Important: Using the correct cable size is critical to achieving the rated performance of the Freedom X unit. When starting a heavy load the Freedom X can draw current surges from the battery of up to 400A. If the DC wiring is too small the voltage drop from this surge will result in a voltage at the Freedom X terminals that is too low for the Freedom X to operate correctly. The Freedom X may appear to operate correctly with smaller cables until a heavy load such as a microwave or refrigerator attempts to start - then the unit may work correctly sometimes and not work correctly other times.

DC Disconnects and Over-Current Devices

The DC circuit from the battery to the Freedom X must be equipped with a disconnect and over-current device. This usually consists of a circuit breaker, a “fused-disconnect”, or a separate fuse and DC disconnect. Do not confuse AC circuit breakers with DC circuit breakers. They are not interchangeable. The rating of the fuse or breaker must be matched to the size of cables used in accordance with the applicable installation codes. The breaker or disconnect and fuse should be located as close as possible to the battery, in the positive cable. Applicable codes may limit how far the protection can be from the battery.

Batteries

The Freedom X uses 12-volt battery banks. Every Freedom X system is recommended to have a deep-cycle battery or group of batteries with a total capacity of 100 Ah or more which provides the DC current that the Freedom X converts to AC.

Ground Fault Circuit Interrupters (GFCIs)

A GFCI is a device that de-energizes a circuit when a current to ground exceeds a specified value that is less than that required to blow the circuit breaker. GFCIs are intended to protect people from electric shocks and are usually required in wet or damp locations.

Installations in marine and recreational vehicles require GFCI protection of branch circuits connected to the AC output of the Freedom X.

The Freedom X GFCI Device (PN: 808-9817) is available to use with the Freedom X inverter unit.

Step 2: Choosing a Location for the Unit

WARNING

FIRE AND EXPLOSION HAZARDS

- Do not install the Freedom X in compartments containing batteries or flammable materials, or in locations that require ignition-protected equipment. This includes any space containing gasoline-powered machinery, fuel tanks, or joints, fittings, or other connections between components of the fuel system. This equipment contains components that tend to produce arcs or sparks.
- Do not cover or obstruct the ventilation openings. Do not install the Freedom X in a zero-clearance compartment. Overheating may result.

Failure to follow these instructions can result in death or serious injury.

The Freedom X should only be installed in locations that meet the following requirements:

- Dry.** Do not allow water or other fluids to drip or splash on the Freedom X. **Do not mount the Freedom X in an area subject to splashing water or bilge water.**
- Cool.** Normal air temperature should be between -4 °F and 104 °F (-20 °C and 40 °C)—the cooler the better.
- Ventilated.** Allow at least 5 inches of clearance at the DC end of the Freedom X for air flow, 1 inch on each side, and 2 inches at the AC end. The more clearance for ventilation around the

unit, the better the performance. Do not allow the ventilation openings on the ends of the unit to become obstructed.

- Safe.** Do not install the Freedom X in the same compartment as batteries or in any compartment capable of storing flammable liquids like gasoline.
- Close to the battery compartment and the AC source and load panels.** Avoid excessive cable lengths (which reduce input and output power due to wire resistance). Use the recommended cable lengths and sizes, especially between the battery banks and the Freedom X.
- Protected from battery acid and gases.** Never allow battery acid to drip on the Freedom X or its wiring when reading specific gravity or filling the battery. Also do not mount the unit where it will be exposed to gases produced by the batteries. These gases are very corrosive, and prolonged exposure will damage the Freedom X.

This section for use by qualified personnel only.

Step 3: Mounting the Unit

To mount the Freedom X:

1. Remove the Freedom X from its shipping container, verify that all components are present, and record relevant product information on “Information About Your System” in the Owner’s Guide.
2. Select an appropriate mounting location and orientation. (See Figure 2 below.) To meet regulatory requirements, for use in on-land applications, the Freedom X must be mounted in one of the following orientations:
 - Under a horizontal surface (see A)
 - In a horizontal position on a vertical surface (see B)

NOTE: For marine installations, only this orientation is allowed, due to the probability of moisture finding access into the enclosure.

- On a horizontal surface (see C)

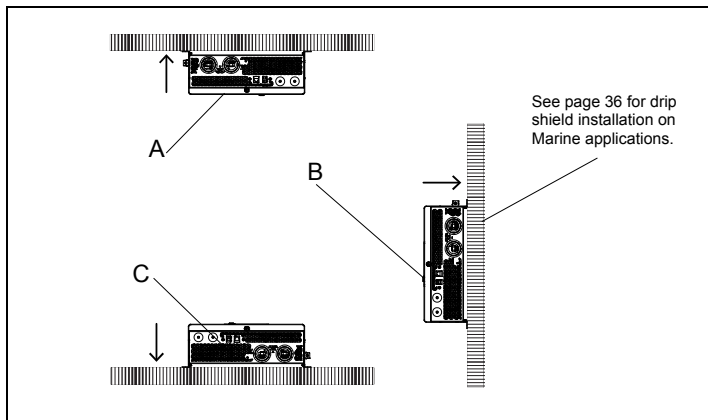

Figure 2 Approved Mounting Orientations

3. Mark the desired number of mounting holes on the wall by placing the unit on the wall.
4. Pilot-drill the mounting holes.
5. Fasten the Freedom X to the mounting surface. If you are mounting the unit on a wall or bulkhead, use #12 or #14 pan-head wood or sheet metal screws to secure it to the framing behind the wall or bulkhead. Alternatively, use nut inserts and ¼"-20 machine screws.

Connecting the Equipment Ground

⚠ WARNING

FIRE HAZARD

Never operate the Freedom X without properly connecting the equipment ground. A fire hazard could result from improper grounding.

Failure to follow these instructions can result in death or serious injury.

The Freedom X has a ground lug on the side of the unit as shown in Figure 3. Follow the guidelines in “Grounding Locations” to connect the inverter’s chassis to the ground.

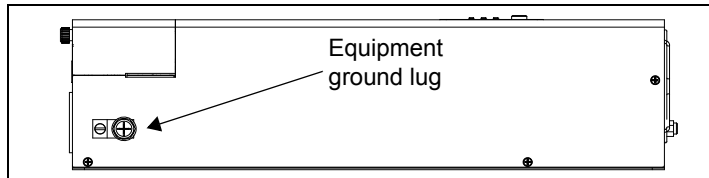

Figure 3 DC Panel Connections

Grounding Locations

You must connect the equipment ground lug to a grounding point—usually the vehicle’s chassis or DC negative bus ground—using recommended copper wire (if insulated then green insulation with or without one or more yellow stripes) or larger.

For recommended equipment ground cable size, see below.

Table 3 Recommended Equipment Ground Cable size

Application	Minimum equipment ground cable size (Stranded cable is recommended)
Recreational Vehicle ^a	No. 8 AWG
Marine ^b	No. 3 AWG (Freedom X 1000) No. 1/0 AWG (Freedom X 2000)

NOTE: There are no restrictions on length for the equipment ground cable.

a. Based on US National Electrical Code NFPA70, Article 551, par. 551-20c.

b. Based on ABYC E-11 11.18.

In general, the equipment ground cable size must not be smaller than one AWG size than the supply cable.

This section for use by qualified personnel only.

Step 4: Connecting the AC Input Wires

⚠ WARNING

FIRE, SHOCK, AND ENERGY HAZARDS

Make sure wiring is disconnected from all electrical sources before handling. All wiring must be done in accordance with local and national electrical wiring codes. Do not connect the output terminals of the Freedom X to any incoming AC source.

Failure to follow these instructions can result in death or serious injury.

General AC Wiring Considerations

AC Wiring Connectors Where applicable, connect AC wires with crimp-on splice connectors. The amount of insulation you strip off individual wires will be specified by the connector manufacturer and is different for different types of connectors.

AC and DC Wiring Separation Do not mix AC and DC wiring in the same conduit or panel. Where DC and AC wires must cross, make sure they do so at 90° to one another. Consult applicable codes for details about DC and AC wiring in close proximity to each other.

AC wiring includes all the wires and connectors between the AC source and the Freedom X and all wiring between the inverter, the AC panels, and circuit breakers. The type and size of the wiring varies with the installation and load. For some RV applications, flexible multiple-strand wire is required.

AC wiring must be sized appropriately to carry full load current on the input and output AC circuits in accordance with the electrical codes or regulations applicable to your installation. Table 4 is based on the U.S. National Electrical Code and the Canadian Electrical Code, assuming two-conductor-plus-ground cable, using 75 °C wiring, at an ambient temperature of 30 °C. Other codes and regulations may be applicable to your installation.

Table 4 Required AC wire size vs. required breaker rating

	Required Breaker Size (amps)	Required Wire Size
Freedom X (both models)	30 A maximum 20 A maximum through a GFCI	10 AWG

The AC input terminal is located inside the unit through the front panel’s knockout hole and is labeled properly as **AC IN** or **AC INPUT**. The unit comes with spring clamp-type terminals where individual wires can be attached securely.

NOTICE
EQUIPMENT DAMAGE Make sure the wires are connected properly. The AC wiring terminal blocks are split into input and output sections. Failure to follow these instructions can damage the unit and/or equipment.

When making the AC input and AC output connections, observe the correct color code for the appropriate AC wire, as described below in Table 5.

Table 5 Color codes for typical AC wiring

Color	AC Wire
Black/Red	Line
White/blue	Neutral

Table 5 Color codes for typical AC wiring

Color	AC Wire
Green/yellow or bare copper	Ground (Earth)

NOTICE
REVERSE POLARITY DAMAGE Make sure the wires are connected properly. Improper connections (connecting a line conductor to a neutral conductor, for example) will cause the Freedom X to malfunction and may permanently damage the inverter. Damage caused by a reverse polarity connection is not covered by your warranty. Failure to follow these instructions can damage the unit and/or equipment.

Wiring Knockouts When installing wires to AC terminals, always remove the appropriate wiring knockouts (there are two on the AC panel) and install the proper strain-relief clamps or bushings.

This section for use by qualified personnel only.

AC Input Connections

1. Ensure AC and DC power sources are turned off.
2. Install the required circuit breaker in the AC distribution panel supplying AC power to the unit.
3. Remove the AC compartment cover by loosening the captive nut panel screw and lifting the cover up and out.

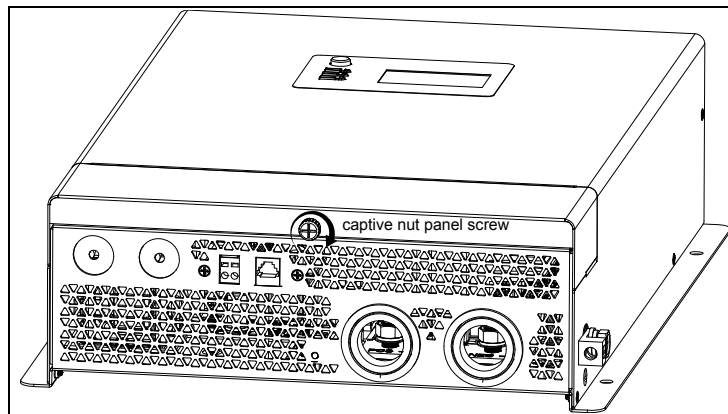

4. Strip a single AC input wire, as appropriate.
5. Remove the knockout and install a 1/2" strain relief clamp.
6. Route the wires through the strain relief clamp (not shown in the figure).

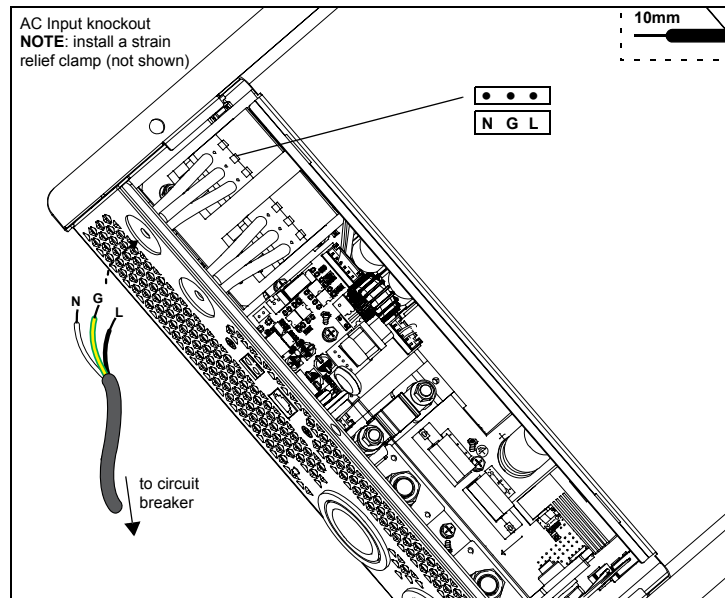

7. Locate the Neutral, Ground and Line terminals on the AC input terminal labeled as **N**, **G**, and **L** respectively.

8. Using a 3mm slot long neck screwdriver, open the spring clamp by inserting the tool in the clamp slot and gently pulling the screwdriver handle forward, for Line terminal.
9. Insert Line AC wire into Line (**L**) terminal slot on the unit.
10. Release the spring clamp to secure the wire.
11. Repeat previous steps 8 through 10 for Ground (**G**) and Neutral (**N**) connections.
12. Tighten the strain relief clamp to secure the wires.
13. Replace the AC compartment cover onto the unit, if you are not connecting other wires such as for the AC Output. Otherwise, keep the AC compartment open and proceed to the next step.
14. Connect the other end of the wires to the circuit breaker in the AC distribution panel supplying AC power to the unit.

This section for use by qualified personnel only.

Step 5: Connecting AC Output to an Existing AC Circuit

⚠ WARNING

FIRE, SHOCK, AND ENERGY HAZARDS

Make sure wiring is disconnected from all electrical sources before handling. All wiring must be done in accordance with local and national electrical wiring codes.

Failure to follow these instructions can result in death or serious injury.

A manufacturer-tested and approved GFCI must be connected to the Freedom X AC output, and GFCI protection must be provided on every receptacle connected to the AC hard wired installation. Other types may fail to operate properly when connected to the Freedom X. See “Ground Fault Circuit Interrupters (GFCIs)” on page 16.

NOTICE

EQUIPMENT DAMAGE

Do not connect any AC source (such as a generator or utility power) to the AC output wiring of the Freedom X.

The Freedom X will not operate if its output is connected to AC voltage from another source, and potentially hazardous or damaging conditions may occur. These conditions can occur even if the inverter is off.

Failure to follow these instructions can damage the unit and/or equipment.

Do not connect the Freedom X to an AC branch circuit that has high-power consumption loads.

The Freedom X will not operate electric heaters, air conditioners, stoves, and other electrical appliances that consume more than its rated watts.

AC Output Connections

To make a permanent connection to existing AC wiring:

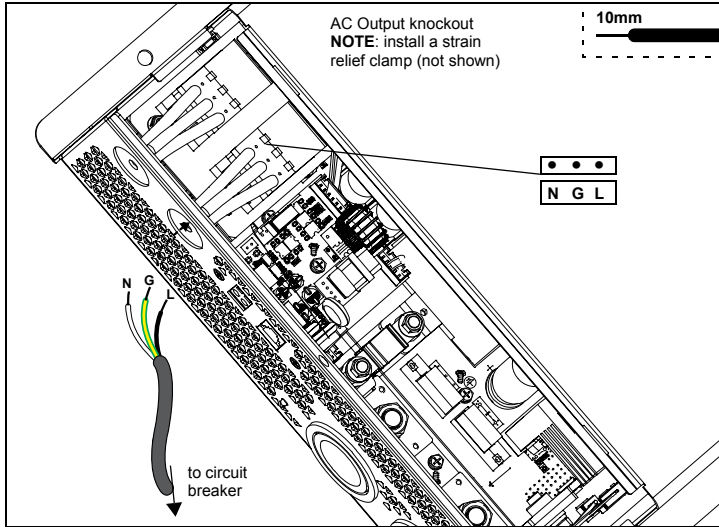

1. Ensure AC and DC power sources are turned off, if not already done from “Step 4: Connecting the AC Input Wires” on page 20.
2. Install the required circuit breaker in the inverter distribution panel receiving AC power from the inverter.
3. Remove the AC compartment cover, if not already done from “Step 4: Connecting the AC Input Wires” on page 20.
4. Strip a single AC output wire, as appropriate.
5. Remove the knockout and install a ½" strain relief clamp.
6. Route the wires through the strain relief clamp (not shown in the figure).
7. Locate the Neutral, Ground and Line terminals on the AC OUT terminal labeled as **N**, **G**, and **L** respectively.
8. Using a 3mm slot long neck screwdriver, open the spring clamp by inserting the tool in the clamp slot and gently pulling the screwdriver handle forward, for Ground terminal.
9. Insert Line AC wire into Line (**L**) terminal slot on the unit.
10. Release the spring clamp to secure the wire.
11. Repeat Step 8 through Step 10 for Ground (**G**) and Neutral (**N**) connections.
12. Tighten the strain relief clamp to secure the wires.
13. Replace the AC compartment cover, if you are finished with connecting all the AC wires in the unit.
14. Connect the other end of the wires to a circuit breaker in the inverter distribution panel.

This section for use by qualified personnel only.

Step 6: Connecting the DC Cables

NOTICE

REVERSE POLARITY DAMAGE

Check cable polarity at both the battery and the Freedom X before making the final DC connection. Positive must be connected to positive; negative must be connected to negative.

Reversing the positive and negative battery cables will damage the Freedom X and void your warranty.

Failure to follow these instructions can damage the unit and/or equipment.

WARNING

FIRE HAZARD

Use only copper wire rated 75 °C minimum. Make sure all DC connections are tight to a torque of 71–80 in-lbf (8–9Nm). Loose connections will overheat.

Failure to follow these instructions can result in death or serious injury.

Follow the procedure given below to connect the battery leads to the terminals on the DC end. The cables should be as short as possible and large enough to handle the required current, in accordance with the electrical codes or regulations applicable to your installation. Table 2 on page 15 specifies the minimum DC cable size and maximum fuse size for the Freedom X.

If at all possible, minimize routing your DC cables through an electrical distribution panel, battery isolator, or other device that will cause additional voltage drops which can degrade the inverter's ability to operate the loads.

Figure 4 shows the DC end for your reference. The reverse polarity LED will light up when the DC cables were reversed during installation.

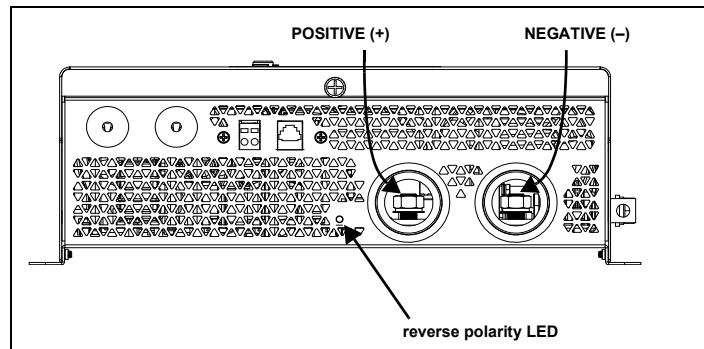

Figure 4 DC End

To make the DC connections

Refer to Figure 5.

1. Make sure the inverter is off and no AC or DC is connected to the unit.
2. Remove the DC compartment cover by loosening the captive nut panel screw.
3. Loosen the DC terminal nuts from the terminal bolts and set them aside for later.
4. Strip $\frac{1}{2}$ " (13 mm) to $\frac{3}{4}$ " (19 mm) insulation from one end of each cable. The amount stripped off will depend on the terminals chosen.
5. Attach the connectors that will secure the cables to the battery, to the disconnect/battery selector switch, and the fuse block. The connectors you use must create a permanent, low-resistance connection. It is recommended to use approved and certified cable lugs. Use the tool recommended by the terminal manufacturer. Make sure no stray wires protrude from the lug or terminal.
NOTE: You may find it more convenient to have the cable lugs attached by the company that sells you the cable and/or connectors.
6. Strip $\frac{1}{2}$ " (13 mm) to $\frac{3}{4}$ " (19 mm) of insulation from each cable end that will be connected to the inverter cable. The amount stripped off will depend on the terminals chosen.
7. Attach the cable lug that will join the cable to the inverter DC terminal. Cover the lug stem with heat shrink insulation (see Figure 5) to ensure that the lug does not touch the enclosure.
8. Install a fuse and fuse holder in the cable that will be used for the positive side of the DC circuit. The fuse must:
 - be as close to the battery positive terminal as possible
 - be rated for DC circuits
 - have an Ampere Interrupting Capacity (AIC) that exceeds the short-circuit current available from the battery (that is, Class T fuse)
9. To prevent sparking when making the connection, ensure the disconnect/battery selector switch is off.
10. Route the positive cable through the left side strain relief clamp and attach the cable lug on the positive cable to the positive DC terminal on the inverter.
11. Fasten the DC terminal nut (set aside earlier) to the terminal bolt. Tighten the nut to a torque of 71–80 in-lbf (8–9 N-m). Do not overtighten. Make the connection snug enough so the cable lug does not move around on the DC terminal. Center it through the DC knockout hole and do not let it touch the edge. See Figure 5, "DC Cable Connections" on page 28.

This section for use by qualified personnel only.

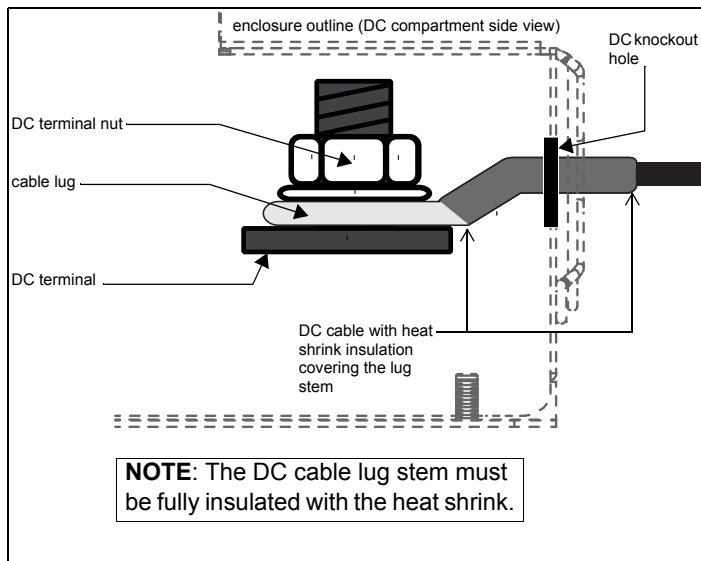

Figure 5 DC Cable Connections

NOTICE

EQUIPMENT DAMAGE

Tighten the nuts on terminals properly. Loose connections cause excessive voltage drop and may cause overheated wires and melted insulation. Do not over-tighten the nut on the DC input terminals. Damage to the DC input terminals may result. The maximum torque setting is **80 in-lbf (9 N-m)**. **Failure to follow these instructions can damage the unit and/or equipment.**

NOTICE

REVERSE POLARITY DAMAGE

Check cable polarity at both the battery and the Freedom X before making the final DC connection. Positive must be connected to positive; negative must be connected to negative. Reversing the positive and negative battery cables will blow a fuse in the Freedom X and void your warranty. **Failure to follow these instructions can damage the unit and/or equipment.**

12. Before proceeding, double check that the cable you have just installed connects the positive DC terminal of the inverter to the disconnect/battery selector switch, fuse holder, and that the other end of the fuse holder is connected to the positive terminal of the battery.

⚠ WARNING**FIRE HAZARD**

Do not complete the next step if flammable fumes are present. Explosion or fire may result if the disconnect/battery selector switch is not in the off position. Thoroughly ventilate the battery compartment before making this connection.

Failure to follow these instructions can result in death or serious injury.

13. Route the negative cable through the right side strain relief clamp and connect the cable from the negative post of the battery to the negative DC terminal of the inverter.
14. Fasten the DC terminal nut (set aside earlier) to the terminal bolt. Tighten the nut to a torque of 71–80 in-lbf (8–9 N-m). Do not overtighten. Make the connection snug enough so the cable lug does not move around on the DC terminal. Center it through the DC knockout hole and do not let it touch the edge.
15. Replace the DC compartment cover.

DC Grounding**To connect the DC ground:**

The equipment grounding lug on the DC end of the Freedom X is used to connect the chassis of the Freedom X to your system's DC negative connection or grounding bus point as required by electrical regulations. Use copper wire that is either bare or provided with green insulation. Do not use the DC Ground Lug for your AC grounding. See the AC wiring instructions in this section.

Follow the guidelines below that correspond to the specific type of installation. These guidelines assume you are using the DC supply cable and fuse sizes recommended in this manual. If you are using different sizes, refer to the applicable installation code for DC grounding details.

Recreational Vehicle Use 8AWG copper wire and connect it between the Chassis Ground lug and the vehicle's DC grounding point (usually the vehicle chassis or a dedicated DC ground bus).

Marine Use copper wire that is bare or has insulation rated minimum 105 °C, and connect it between the Chassis Ground lug and the boat's DC grounding bus or engine negative bus. For the Freedom X 1000, use a wire of gauge 3AWG minimum. For the Freedom X 2000, use a wire of gauge 1/0AWG minimum.

This section for use by qualified personnel only.

Connecting to ACC Signal

The Freedom X can be wired to inhibit inverter operation in the absence of a vehicle's (or vessel's) ignition control signal. This feature can avoid unnecessary battery drain that would otherwise occur if the inverter was operated without a charging source such as the vehicle alternator.

To enable ignition control:

1. Ensure that AC and DC power are both OFF.
2. Ensure the vehicle's ignition is turned to OFF position. It is highly recommended to remove battery power by disconnecting the vehicle's battery cables. Refer to the vehicle's user manual for proper instructions on how to disconnect the battery cables.
3. Locate the vehicle's ignition control wire from the vehicle's ignition circuit. This wire must be fused appropriately at no more than 5 amps. Refer to the vehicle's user manual for guidance.
4. Locate the ACC input (ignition signal input) terminal. See Figure 6.

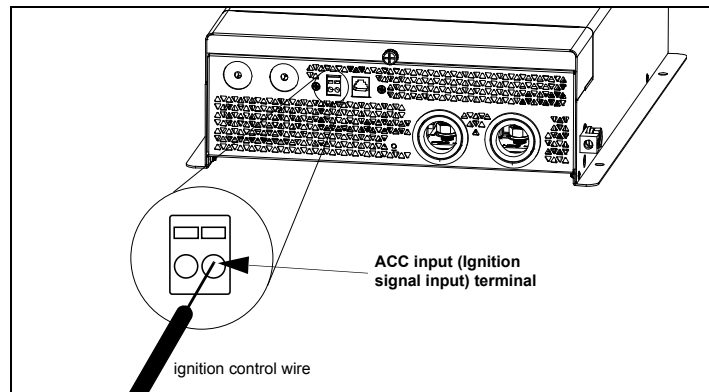

Figure 6 Ignition Signal (ACC) Input Terminal

5. Using a 3mm slot long neck screwdriver, push into the rectangular slot to release the spring clamp.
6. Insert the ignition control wire into the round ACC input terminal slot.
7. Pull the screwdriver out to engage the spring clamp and secure the wire to the terminal.

Description of Ignition Control Features

For information about the features and instructions on changing the ignition control features, see “Inverter Operation” on page 39.

Ignition Auto-on (AEO)	This setting allows the inverter to operate (Battery mode) automatically when an ignition control wire is connected to the ACC input and a valid ignition signal is constantly detected. The inverter works in tandem with the vehicle’s ignition circuit.
Ignition Lock-out (LOI)	This setting allows the inverter to operate (Battery mode) when an ignition control wire is connected to the ACC input terminal and a valid ignition signal is constantly detected. When enabled, you have to manually press the Power button on the display panel to operate the inverter.
Off (OFF)	To completely disable the ignition control features do the following: 1. Set Ignition Control to Off (OFF) using the Select buttons on the Display panel.

This section for use by qualified personnel only.

Step 7: Connecting to a Remote Panel

To connect the remote panel:

- ◆ Plug the Freedom X Remote panel (PN: 808-0817) to the RJ12 Remote port on the unit.

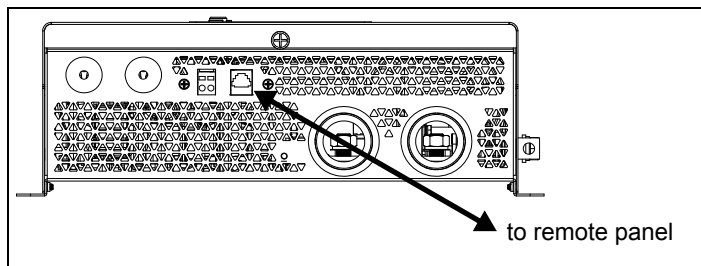

NOTE:

When the remote panel is connected, turn the inverter's power button to the OFF position. This allows the remote panel to control the inverter's power status.

Step 8: Testing Your Installation

WARNING

ELECTRICAL SHOCK HAZARD

Pressing the Power button to turn OFF the Freedom X inverter function on display panel does not disconnect DC or AC input power to the Freedom X. If shore power is present at AC input terminals, it will pass through to the AC output.

Failure to follow these instructions can result in death or serious injury.

There are two tests to be performed. The first test verifies that the Freedom X is inverting DC battery power and delivering AC power to its output.

The second test is intended for installations where AC input and output is hard wired to the Freedom X. This test verifies that the Freedom X transfers from inverter power to shore power when shore power is present.

NOTE: Shore power (pass-through) refers to the AC input power from a utility grid, generator or external AC source.

When you are ready to test your installation and operate the Freedom X, close the DC fuse and Disconnect or the DC circuit breaker to supply DC power to the Freedom X.

Testing in Battery Mode

To test the Freedom X in invert mode:

1. For hard wired installations, ensure shore power is not present.
2. Press the Power button to turn the inverter on.
The green LED indicating Battery mode (Inverter mode) turns on and the LCD screen displays the **BATT. MODE** icon.
3. Plug a test load, such as a lamp within the power rating of the inverter into the Freedom X GFCI or an AC outlet hard wired to the Freedom X.
4. Turn the lamp on to verify that it operates.

If the lamp operates, your installation is successful. If your installation has AC input and output hard wired to the Freedom X, proceed to “Testing in Grid Mode”.

If the status LED on the display panel glows red, see the Troubleshooting chapter.

This section for use by qualified personnel only.

Testing in Grid Mode

To test the Freedom X in shore power mode:

- ◆ With the test load from the previous test still connected and operating, connect the shore power source.

The Freedom X transfers the test load to shore power. The green LED indicating grid mode turns on and the LCD screen displays the **AC MODE** icon.

If the test load operates, your installation is successful.

NOTE: If the Power button on the Freedom X is turned ON, the Freedom X will automatically supply the appliances with inverter power if the shore power source fails or becomes disconnected.

If the Power button on the Freedom X is turned ON and shore power voltage is too low (less than 90 volts AC), the unit will transfer to inverter power to continue running your appliances.

NOTE: Whether or not the Power button is turned ON, shore power will pass through the Freedom X to the output when shore power is within normal operating range.

NOTE: In the event of low or no battery voltage, shore power will pass through the Freedom X to the output even when shore power is outside the normal operating range.

Marine Installation

Figure 7 illustrates a typical marine installation with the following components:

1. AC power supplied from a shore power connector
2. An AC source panel that includes a max 30A (or a 15A if using a GFCI) circuit breaker that supplies the Freedom X
3. An AC load panel with branch circuit breakers that supply only loads that run off the Freedom X
4. Engine negative bus / DC ground bus
5. DC power supplied by a battery bank and protected by a DC fuse in the positive cable
6. Battery isolator
7. DC alternator
8. Starting battery
9. Drip shield (see next page)

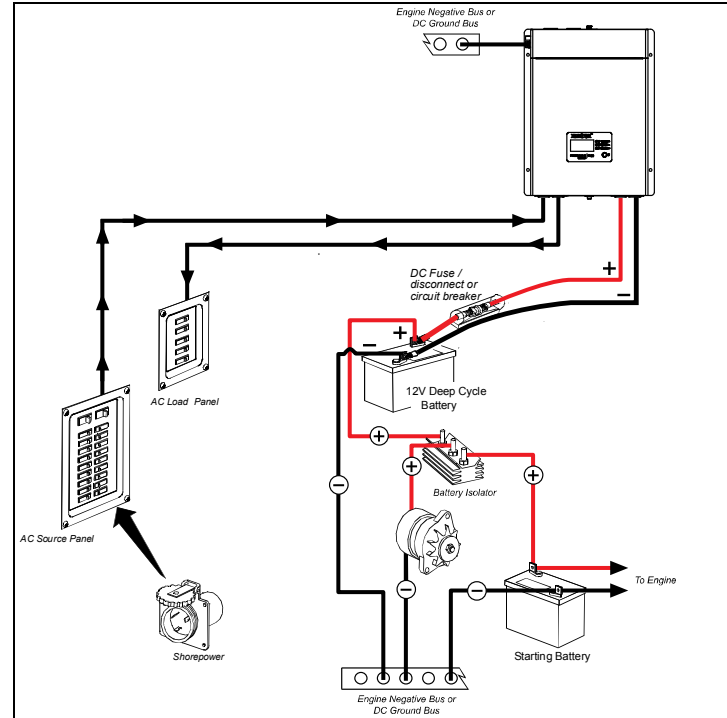

Figure 7 Typical Marine Installation

This section for use by qualified personnel only.

Drip Shield Installation

The drip shields help to protect the unit from dripping or splashing liquids, which will cause a shock hazard when moisture comes in contact with electrical circuits in the unit. The drip shields are especially useful in marine installations where water from condensation, rain, or sea may come into contact with the Freedom X.

⚠ WARNING

ELECTRICAL SHOCK HAZARD

Place this unit in normally dry areas only. Operating the unit under wet conditions may expose you to a shock hazard. Installing drip shields may not entirely protect you from this hazard. Do not operate the unit when it is wet.

Failure to follow these instructions can result in death or serious injury.

You may purchase the drip shield set by contacting customer support. When ordering, mention part number 808-1050.

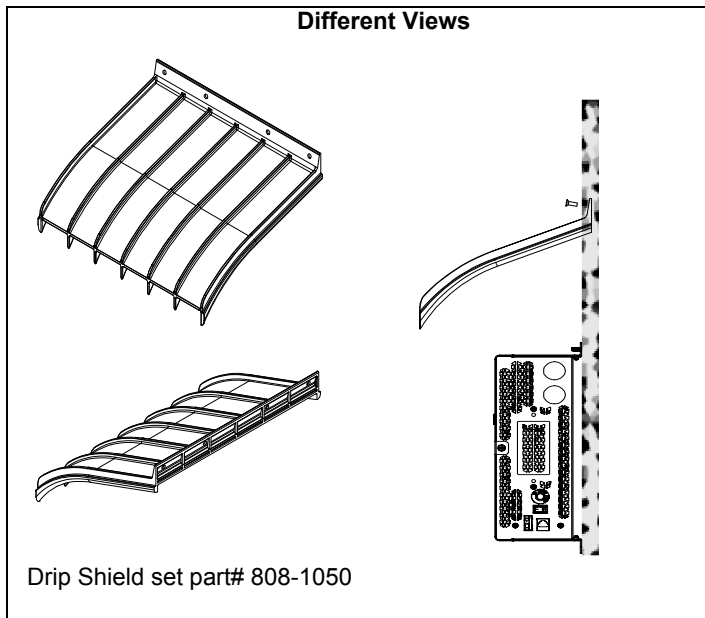

Figure 8 Drip Shields

To install the drip shields:

1. Gather the four screws needed to fasten a single drip shield to a wall.
2. Locate an appropriate setting for the drip shields above the Freedom X making sure you cover the entire width of the unit. You can overlay the shields as shown in Figure 9 below.
3. Fasten the screws through the holes in the drip shield into the wall. See Figure 8.

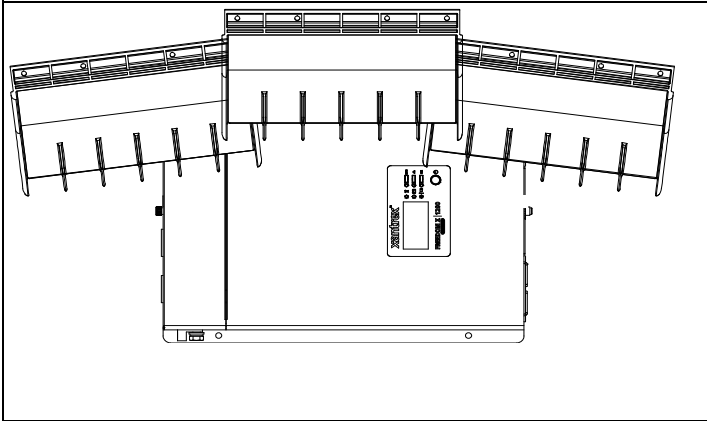

Figure 9 Typical Drip Shield Placement on a Freedom X 1000

Inverter Operation

Freedom X Display Panel

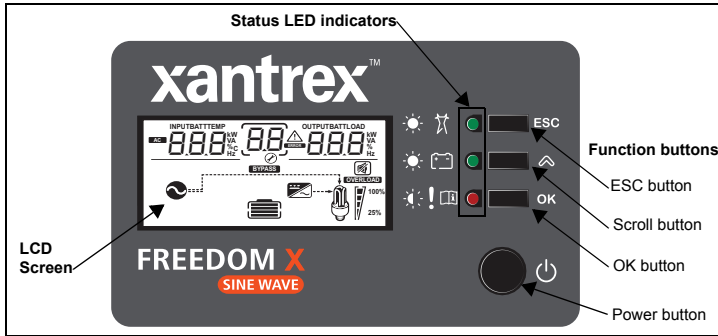



Figure 10 Display Panel

Status LED Indicators

Indicator	Definition
 <i>solid green</i>	Indicates grid mode in which shore power is available and passing through to the loads.
 <i>solid green</i>	Indicates Battery mode (Inverter mode) in which the inverter is running and supplying power to the loads from the battery.
 <i>solid red</i>	Indicates error or fault mode and is accompanied by an error code displayed on the LCD screen. For a list of error codes, see “Warning Messages” on page 58.
 <i>flashing red</i>	Indicates a Warning condition and is accompanied by an error code and a sounding alarm. For a list of error codes, see “Warning Messages” on page 58.

Function Buttons

Button	Definition
ESC	return to default screen or exit setting mode
	next screen or next selection
OK	to enter the setting mode or to confirm the setting
	turns the inverter on or off

LCD Screen

The LCD Screen changes depending on the operating mode of the inverter.

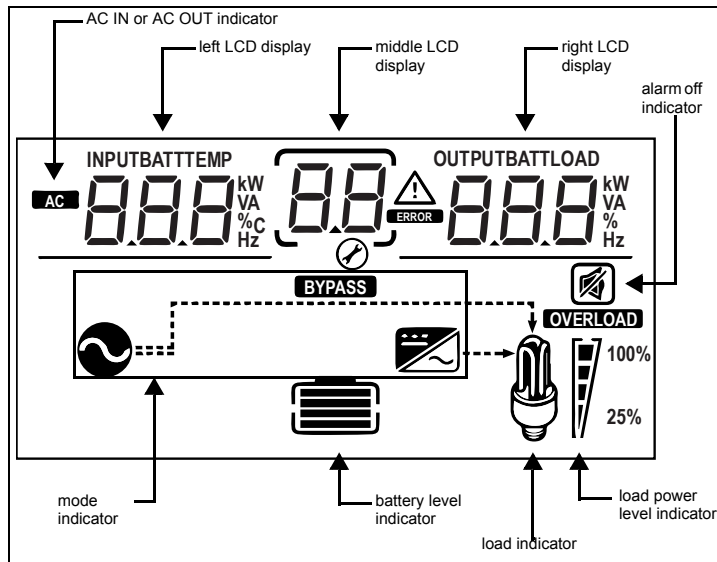







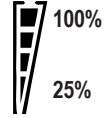





Figure 11 Parts of the LCD Screen

LCD Screen Icons

Icon	Definition
	AC input and output indicator.
	The wrench icon underneath a number is displayed during configuration mode.
	An error event with its corresponding number is displayed here.
	A warning event with its corresponding number is displayed here.
	The battery icon indicates remaining battery power. One bar = 1-25%, two bars = 25-50%, three bars = 50-75%, and four bars = 75-100%.
	Shows an overload condition.
	The load icon is displayed if there is voltage available at the AC output.

Icon	Definition
	The bar represents load consumption levels. 100% is an indication of full capacity and 25% indicates low consumption. All the bars disappear at < 20 watts, and AC load indicates zero watt power.
	Shows up in grid mode when AC shore power is present. If the power is being qualified, then this icon will flash.
	Shows that the unit is in grid mode and is bypassing shore power directly to the loads.
	This icon shows when there is power conversion from DC to AC - inverting.
	The alarm buzzer is muted.

Viewing Information During Battery Mode

The LCD screen displays information related to battery mode operation.

- ◆ Press the Scroll  button to move from screen to screen.

Info and Setting LCD Screen

Screen 1 of 4 -
Battery Voltage/
Load Wattage

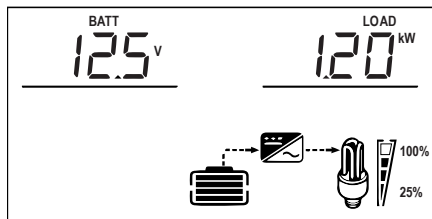

This is the home screen.

battery voltage = 12.5V, AC load = 1.2kW

Screen 2 of 4 -
AC Output
Voltage/Frequency

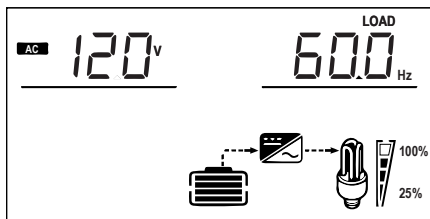

output voltage = 120V, output frequency=60Hz

Info and Setting LCD Screen

Screen 3 of 4 -
AC Input Voltage/
Frequency

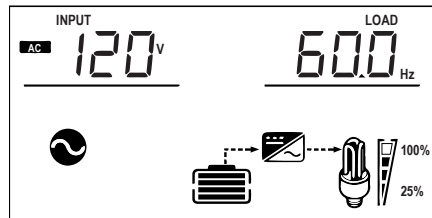

Screen shows up when utility AC is connected.

input voltage = 120V, input frequency = 60Hz

Screen 4 of 4 -
Firmware version

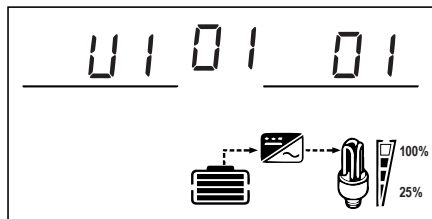

Firmware version = U1 1.01

Viewing Information During Grid Mode

The LCD screen displays information related to AC bypass or charger operation.

1. Press the Scroll  button to move from screen to screen.
2. Press **ESC** to return to the home screen.

NOTE: After one minute of inactivity in the other screens, the LCD will go back to the home screen.

Info and Setting LCD Screen

Screen 1 of 3 -
AC input current/
AC load current

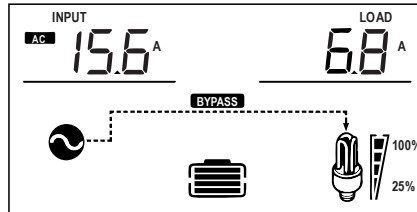

input current = 15.6A, load current = 6.8A

Info and Setting LCD Screen

Screen 2 of 3 -
AC input voltage/
AC input
frequency

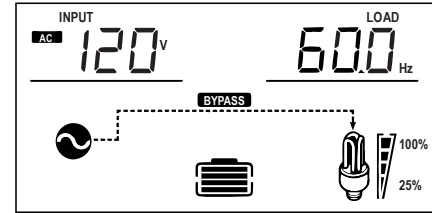

input voltage = 120V, input frequency = 60Hz

Screen 3 of 3 -
Firmware version

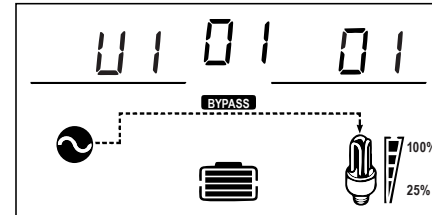

Firmware version = U1 1.01

Adjusting Feature Settings in Configuration Mode

The **OK**, Scroll , and **ESC** buttons can be used to cycle through the various feature settings:

1. Press and hold the **OK** button for three seconds to enter the feature settings mode.
2. Press the Scroll  button to move through the different feature settings.

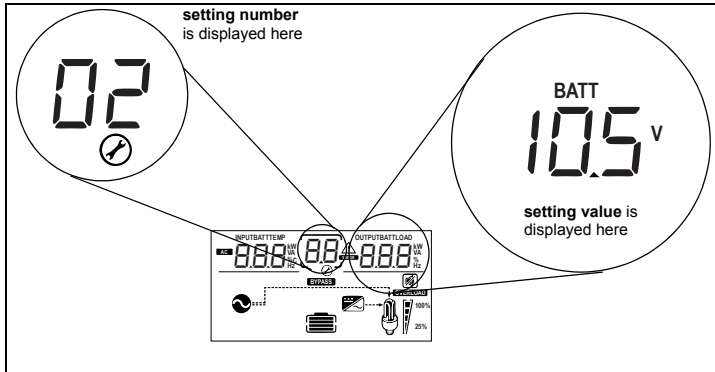

Settings



Setting Name	Setting Number	Default Value	Range of Values	Description
Inverter Ignition Control	01	OFF	OFF, L0t, Ato	See “Description of Ignition Control Features” on page 31.
LBCO Voltage	02	10.5	10.1 to 12.8	The voltage setting value can be adjusted by 0.1 increments. The low battery warning is triggered at LBCO voltage + 0.5 volts. The low battery warning goes away at LBCO voltage + 1.0 volts.
LBCO Shutdown Delay Timer	03	300	1 to 300	When the range is from 1 to 20, the timer setting value can be adjusted by 1-second increments. When the range is from 20 to 300, the timer setting value can be adjusted by 10-second increments.
LBCO Recovery Voltage	04	13.1	12.0 to 16.0	The range is from LBCO voltage + 0.5 to 16, adjusted by 0.1 increments. Selecting a higher value than the battery’s actual fully-charged voltage level will not activate the auto-recovery feature. You may manually reset the inverter when the low battery cut off event occurs.
Power Save Time	05	25	OFF, 1 to 25	The range is from 1 to 25, adjusted by 1-hour increments. The next setting after 25 is OFF.
Power Save (Load Sensing) Mode	06	d1 5	EnA (enable), d1 5 (disable)	When enabled, the inverter’s “no load” loss can be reduced further when total load is less than 25 watts.
Output Frequency	07	60	60, 50	After changing the output frequency setting, turn the unit off and then on again, in order for the change to take effect.
Output Voltage	08	120	120, 110, 108	

Adjusting Feature Settings in Configuration Mode

Setting Name	Setting Number	Default Value	Range of Values	Description
Inverter Output Power Limit (Freedom X 1000)	09	1.0	100 to 1.0	The wattage setting value can be adjusted by 100-watt increments. Use with Inverter Output Power Limit Timer especially when pairing with a lithium ion battery.
Inverter Output Power Limit (Freedom X 2000)	09	2.0	100 to 2.0	
Inverter Output Power Limit Timer	10	300	1 to 300, OFF	When the range is from 1 to 20, the timer setting value can be adjusted by 1-second increments. When the range is from 20 to 300, the timer setting value can be adjusted by 10-second increments. Use with Inverter Output Power especially when pairing with a lithium ion battery. The timer is automatically disabled if the maximum Inverter Output Power limit is selected.
Transfer Mode	11	AFL	AFL (appliance), UPS (UPS)	Selecting AFL - appliance sets the transfer time from line to battery to 20 ms. Selecting UPS (uninterruptible power supply) sets the transfer time from line to battery to 10 ms. NOTE: Do not connect motor loads when in UPS transfer mode. See “Inverter Applications” on page 64.
Utility AC Under Voltage Level	12	90	85 to 110	
Inverter Shutdown Recovery	13	ARL	ARD (auto-restart), ARL (manual restart)	The inverter shuts down when there is an over temperature, overload, and short circuit condition. Selecting ARD (auto-restart) will allow the inverter to recover automatically from a shutdown up to three times maximum. Selecting ARL (manual restart) allows the user to restart the inverter by performing a manual reset, that is, by acknowledging the restart via the display panel.





Setting Name	Setting Number	Default Value	Range of Values	Description
Audible Alarm	14	b0n	b0n (Audible), b0F (Mute)	The alarm beeps once every five seconds.
Battery Type	20	FLd	FLd (Flooded), AGM (AGM), GEL (Gel), USE (Custom)	
Battery Temperature	21	HDt	CLd (Cold), wrn (Warm), HDt (Hot)	Selecting Cold from Warm will increase charger voltage by 0.4V. Selecting Cold from Hot will increase charger voltage by 0.8V.
Reset all settings to their default values	99	dEF	ndF (as is), dEF (default)	

To change the default value to a different value:

1. Press and hold the **OK** button for three seconds to enter the feature settings mode.
2. Press the Scroll  button to move through the different feature settings.
3. Press the **OK** button to select a setting number and change its value.
4. Press the Scroll  button to change the value until you reach the desired value.
5. Press the **OK** button to confirm the change.
6. Repeat the previous steps to set other feature settings.
7. Press the **ESC** button to exit the feature settings mode.

Operating in Battery Mode

The Freedom X is in Battery Mode (also called Inverter Mode) when all the following conditions exist:

- inverter power button is ON  (down position) or ignition auto-on is activated
- shore power is not presently available   
- battery has sufficient power

Inverter operation means that DC battery power is presently being converted to utility grade AC power, powering equipment and appliances connected to the AC output terminal of the unit.

The green status LED lights up to indicate the Freedom X is using the battery to power the equipment and appliances.

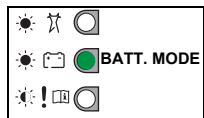

Turning Inverter Operation ON and OFF

There are two ways to operate the Freedom X's inverter.

- Press the Power button to a down position (it is Off in the up position).
- When the inverter's Ignition Control feature is set to Auto-on (A&D)^a, a +12VDC signal is present^b.

WARNING

ELECTRICAL SHOCK HAZARD

Turning the Power button off does not disconnect DC battery power from the Freedom X. You must disconnect both AC and DC power before working on any circuits connected to the unit.

Failure to follow these instructions can result in death or serious injury.

To prevent unnecessary battery discharge, press the Power button to turn it off when you are not using the Freedom X.

a. See "Adjusting Feature Settings in Configuration Mode" on page 44.

b. When the vehicle's ignition switch is On or the vehicle's engine is running.

Power Save Timer

The Power Save Timer is an adjustable countdown timer from 1 to 25 hours (25 hours is the default) that automatically shuts down inverter operation to reduce battery discharge and preserve battery life. During continuous inverter operation, the countdown is initiated when power from the AC load drops to less than approximately 50 watts and remains below this level. After reaching the end of the countdown timer the inverter automatically shuts down.

To change the countdown timer, see “To change the default value to a different value:” on page 48.

Power Save Mode: By enabling the power save mode, the inverter can automatically go to load sense mode by sending short pulses to further reduce the battery discharge. Power save mode ends when a load greater than 25 W is connected.

Checking Battery Status

During inverter operation (in battery mode), you can check the battery status by observing the battery capacity indicator on the LCD screen. The battery voltage appears in the left side of LCD screen.

The normal operating battery voltage range is between 11 and 15 volts.

Checking Output Power

When the inverter is in operation (in battery mode), you can check how much power (displayed in kW) the Freedom X is supplying to the connected loads by observing the load capacity indicator on the LCD screen. The battery discharge amperage appears in the right side of the LCD screen.

Operating Several Loads at Once

If you are going to operate several loads from the Freedom X, turn them on one at a time after you have turned the inverter on.

Turning loads on separately helps to ensure that the inverter does not have to deliver the starting current for all the loads at once, and will help prevent an overload shutdown.

Turning the Audible Alarm ON or OFF

The Freedom X's audible alarm can be muted. See “Adjusting Feature Settings in Configuration Mode” on page 44.

Any warnings such as error or fault conditions or imminent shutdown are both displayed on the LCD screen and sounded on the alarm speakers. See “To manually reset the alarm:” below.

Audible alarm for warning: The unit beeps once when a warning condition is detected.

Audible alarm for error: The unit beeps once every five seconds for one minute.

To mute the alarm:

◆ Press any one of the three function buttons.

The alarm is automatically muted after one minute. But the error code continues to be displayed until the error is cleared.

To manually reset the alarm:

1. Press the Power button to turn it Off (from a down position to up) and press again to turn it On to reset an active alarm and clear the error or error.
2. If the Inverter Ignition Control is set to auto-on, toggle the ignition signal to clear the alarm and error.
3. Toggle the AC input power to force the transition between grid mode and battery mode. This action clears the alarm and error.

Operating During Transition Between Grid Mode and Battery Mode

The Freedom X's advanced power management is capable of transitioning power from an AC source to DC source within a fraction of a second and vice-versa.

The Freedom X automatically detects when shore power is present and when it becomes unavailable or drops to less than 90 volts AC.

The transfer time can be set to two settings. For details see "Adjusting Feature Settings in Configuration Mode" on page 44.

NOTICE

EQUIPMENT DAMAGE

When the transfer mode is set to *UPS*, connect only sensitive digital equipment that requires fast AC transfer times.

Appliances with motors, compressors, and heating elements do not require a transfer mode of *UPS*. Set *RPL* for these devices to avoid damaging the transfer relay.

Failure to follow these instructions may cause equipment damage.

Transitioning from Grid Mode to Battery Mode

When the unit is operating in grid mode and shore power is lost, the Freedom X has less than 20 milliseconds (default) to switch to operating in battery mode (if the Power button is pressed in the On position) and starts drawing power from the battery.

The operating mode indicator will change to Battery Mode and the green Status LED for Battery Mode will light up.

However, if the Power button is in the Off position, this transition does not happen and the display panel turns off.

Transitioning from Battery Mode to Grid Mode

When the unit is operating in Battery Mode and shore power becomes available, the Freedom X begins a 20-second countdown to verify the stability of the shore power. If shore power remains stable for a 20-second countdown, at the end of the countdown, the Freedom X will switch to shore power mode within 20 milliseconds and start drawing power from the AC source.

The operating mode indicator will change to grid mode and the green Status LED for grid mode will light up.

Operating Limits

Power Output

The Freedom X can deliver up to 1000 watts (Freedom X 1000) and 2000 watts (Freedom X 2000) of continuous utility grade sine wave AC power. The wattage rating applies to resistive loads such as incandescent lights.

Input Voltage

The allowable Freedom X input battery voltage ranges are shown in the following table:

Operating Condition	Battery Voltage	Comment
Full Operating Range	LBCO – 18.0 volts	Assuming the battery is full, the inverter will operate until battery voltage goes past below LBCO ^a and LBCO Shutdown delay timer ^b .
Low Voltage Alarm	< LBCO+0.5 volts	A low battery warning shows error code <i>E05</i> on the LCD screen.
Low Voltage Shutdown	< LBCO	The buzzer sounds a single one-second low battery alarm beep and the LCD screen shows error code <i>E01</i> . After LBCO Shutdown delay timer runs out, the unit shuts down inverter output. The buzzer stops beeping and the LCD screen shows error code <i>E01</i> .

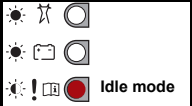
Operating Condition	Battery Voltage	Comment
Instant Low Voltage Shutdown	< 10.2 volts	After two seconds below the limit, the unit shuts down inverter output completely. LCD screen turns off completely.
High Voltage Shutdown	18.0 volts	The display shows error code <i>E02</i> alternating with the battery voltage. The red status LED turns on. 

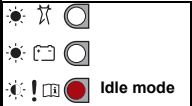

NOTE: Although the Freedom X incorporates over-voltage protection, it can still be damaged if input voltage exceeds 18.0 volts.

a. To set LBCO, see “Adjusting Feature Settings in Configuration Mode” on page 44.
b. To set LBCO Shutdown Delay Timer, see “Adjusting Feature Settings in Configuration Mode” on page 44.

Overload Conditions

There are two kinds of overload conditions:

- an overload warning
- an overload shutdown

Overload Warning When the Freedom X's AC load is approximately 100 W below the overload shutdown limit of rated watts, the audible alarm beeps once and the LCD screen shows a error code `E05`.

Overload Shutdown When the Freedom X's AC load increases to near ~1100 W (Freedom X 1000) and ~2100 W (Freedom X 2000), the audible alarm beeps every five seconds for one minute and the LCD screen shows a error code `E03`. The Status LED turns solid RED.

High Surge Loads

Some induction motors used in freezers, pumps, and other motor-operated equipment require high surge currents to start. The Freedom X may not be able to start some of these motors even though their rated steady state current draw is within the inverter's limits. The unit will shut down and indicate an overload shutdown.

Over-temperature Conditions

During inverter operation, when the Freedom X's internal temperature starts to approach its preset shutdown limit, the display will show error code `E07`. If the over-temperature condition persists, the display will show error code `E04`. The Status LED turns solid RED and the inverter will shut down to prevent damage to the inverter and protect the battery from being over-discharged.

Routine Maintenance

Freedom X Unit

Minimal maintenance is required to keep your Freedom X operating properly. Periodically you should:

- Clean the exterior of the unit with a damp cloth to prevent the accumulation of dust and dirt.
- Ensure that the DC cables are secure and fasteners are tight.
- Make sure the ventilation openings are not clogged.

Troubleshooting

WARNING

ELECTRICAL SHOCK HAZARD

Do not disassemble the Freedom X. It does not contain any user-serviceable parts. Attempting to service the unit yourself could result in an electrical shock or burn.

Failure to follow these instructions can result in death or serious injury.

IMPORTANT: To obtain service go to “Contact Information” on page i.

This section will help you narrow down the source of any problem you encounter. Before contacting customer service, please work through the steps listed below:

1. Check for any error codes displayed on the LCD screen. If a message is displayed, record it before doing anything further.
2. As soon as possible, record the conditions at the time the problem occurred so you can provide details when you contact customer service for help. Include the following information:
 - What loads the Freedom X was running or attempting to run
 - What the battery condition was at the time (voltage, etc.) if known
 - Recent sequence of events
3. If your Freedom X is not displaying an error code, check the following to make sure the present state of the installation allows proper operation:
 - Is the inverter located in a clean, dry, adequately ventilated place?
 - Are the battery cables adequately sized as recommended in the Installation guide?
 - Is the battery in good condition?
 - Are all DC connections tight?
 - Are the AC input and output connections and wiring in good condition?
 - Are the configuration settings correct for your particular installation?
 - Are all disconnects and AC breakers closed and operable?
 - Have any of the fuses blown in the installation?
4. Contact customer support for further assistance. Please be prepared to describe details of your system installation and to provide the model and serial number of the unit.

Warning Messages

Warning messages in the form of audible alarms and error codes that appear on the LCD screen to alert you to an impending system change. Warnings do not affect operation.

With the exception of the error codes displayed on the screen, only the audible alarm can be turned ON or OFF. Follow the steps in “Turning the Audible Alarm ON or OFF” on page 51 to change the alarm settings.

The error codes are listed in Table 6 below. The text in the **Error Code** column appears on the LCD screen of the display panel.

Table 6 Error Codes Displayed on the LCD Screen

Error Code	Condition	Mode	Action
E01	Low battery voltage shutdown is imminent depending on the setting, see “Operating Limits” on page 53.	Battery mode (inverting)	<ul style="list-style-type: none">• Check battery status and recharge if necessary.• Check for proper DC cable sizing.• Check for loose connections and tighten if necessary.
E02	High battery voltage shutdown > 18.0 volts DC	Battery mode (inverting)	<ul style="list-style-type: none">• Check for external charging sources, such as a PV charger and an over voltage alternator. Disconnect, if necessary.
E03	AC output overload shutdown	Battery mode (inverting)	<ul style="list-style-type: none">• Reduce the loads connected to the AC outlet of the unit.• Check appliances that have high-surge ratings and disconnect if necessary.
E04	Over-temperature shutdown	Battery mode (inverting)	<ul style="list-style-type: none">• Reduce the loads connected to the AC outlet of the unit.• Check that the ventilation grille is not blocked.• Check for ambient temperature and move the unit to a cooler location whenever possible.

Table 6 Error Codes Displayed on the LCD Screen

Error Code	Condition	Mode	Action
<i>E05</i>	Low battery voltage detected depending on setting, see “Operating Limits” on page 53.	Battery mode (inverting)	<ul style="list-style-type: none"> • Check battery status and recharge if necessary. • Check for proper DC cable sizing. • Check for loose connections and tighten if necessary.
<i>E06</i>	AC output overload warning	Battery mode (inverting)	<ul style="list-style-type: none"> • Reduce the loads connected to the AC outlet of the unit.
<i>E07</i>	Over-temperature alarm and fan lock alarm	Battery mode (inverting)	<ul style="list-style-type: none"> • Reduce the loads connected to the AC outlet of the unit. • Check that the ventilation grille is not blocked. • Check for ambient temperature and move the unit to a cooler location whenever possible. • Check the fan for any obstruction and remove it.
<i>E08</i>	Fan lock error	Battery and grid modes	<ul style="list-style-type: none"> • If there is no issue with the fan, disconnect the unit from its DC and AC power sources, then reconnect, and then restart the unit. Perform “Step 8: Testing Your Installation” on page 33. • If error detection persists, contact customer service.
<i>E 10 to E 19</i>	Internal hardware error	Battery and grid modes	<ul style="list-style-type: none"> • If error detection persists, contact customer service.

For error code *E01*: after the LBCO shutdown delay, the unit will immediately stop inverting

For error codes *E02* to *E04*: the unit will stop inverting

Troubleshooting Reference

WARNING

ELECTRICAL SHOCK HAZARD

Do not disassemble the Freedom X. It does not contain any user-serviceable parts. Attempting to service the unit yourself could result in an electrical shock or burn.

Failure to follow these instructions can result in death or serious injury.

NOTICE

INVERTER DAMAGE

Avoid continually overloading the inverter and subjecting it to over temperature conditions. Although provided with integral protection against overloads continual overloading can damage the circuitry.

Failure to follow these instructions can damage the inverter.

Table 7 Troubleshooting Reference

Problem	Possible Cause	Solution
Alarm does not sound when an error is encountered.	Alarm is turned OFF.	See “Turning the Audible Alarm ON or OFF” on page 51 and follow instructions to turn the alarm buzzer on again.

Table 7 Troubleshooting Reference

Problem	Possible Cause	Solution
No output voltage. The status LED is red.	AC shore power is not available or out of operating range and the inverter has shut down with the LCD screen showing one of the following error codes:	
	<ul style="list-style-type: none"> • Low input voltage (error code E01) 	<ul style="list-style-type: none"> • Check the DC connections and the cable. • Recharge the battery.
	<ul style="list-style-type: none"> • High input voltage (error code E02) 	<ul style="list-style-type: none"> • Verify the unit is connected to a 12V battery. • Check the voltage regulation of the external charging system (if any).
	<ul style="list-style-type: none"> • Unit overload or AC output short circuit (error code E03) 	<ul style="list-style-type: none"> • Reduce the load. Make sure the load does not exceed the output rating.
	<ul style="list-style-type: none"> • Thermal shutdown (error code E04) 	<ul style="list-style-type: none"> • Allow the unit to cool off. • Reduce the load if continuous operation is required. • Improve ventilation. Make sure the inverter's ventilation openings are not blocked.

Table 7 Troubleshooting Reference

Problem	Possible Cause	Solution
No output voltage is shown in the LCD screen but the green status LED for Battery mode is illuminated.	<p>GFCI (when installed) has tripped or supplementary breaker has tripped.</p> <p>Circuit breaker on the AC load panel or AC output disconnect has tripped.</p> <p>Battery voltage is too low (depending on setting, see “Operating Limits” on page 53) to start inverting. LCD screen may show DC voltage as 000.</p>	<p>Check load and reset the GFCI or supplementary breaker.</p> <p>Reset the circuit breaker or check the AC output disconnect circuits.</p> <p>Check DC connections and cable. Recharge battery.</p>
No output voltage is shown in the LCD screen and neither of the green status LEDs (for Grid mode and Battery mode) is illuminated.	<p>AC shore power is not available or out of operating range and the inverter is OFF.</p> <p>AC shore power is not available and the inverter is OFF due to a shutdown for more than 30 seconds.</p>	<ul style="list-style-type: none"> • Check AC shore power. • Turn the inverter ON. <ul style="list-style-type: none"> • Check AC shore power and battery voltage. • Turn the inverter ON and look at the LCD screen for any error code. • See Table 6, “Error Codes Displayed on the LCD Screen” on page 58.
No output voltage. The status LED is not lighting up.	Ignition lock (ACC) signal is not present.	If the ignition control feature is in use, ensure the vehicle’s ignition is On and the ignition control switch on the front of the Freedom X 1000 unit is On (I).

Table 7 Troubleshooting Reference

Problem	Possible Cause	Solution
The fan turns on and off during AC shore power mode.	<ul style="list-style-type: none">• The battery is discharged.• AC pass-through current is high.	Do not be alarmed, the unit is performing normally.
The fan turns on and off during inverter mode.	The inverter is running continuously at high power.	Do not be alarmed, the unit is performing normally. The fan is activated automatically.

Inverter Applications

The Freedom X performs differently depending on the AC loads connected to it. If you are having problems with any of your loads, read this section.

Resistive Loads

These are the loads that the inverter finds the simplest and most efficient to drive. Voltage and current are in phase (that is, in step with one another). Resistive loads usually generate heat in order to accomplish their tasks. Toasters, coffee pots, and incandescent lights are typical resistive loads. It is usually impractical to run larger resistive loads—such as electric stoves and water heaters—from an inverter due to their high current requirements. Even though the inverter can most likely accommodate the load, the size of battery bank required would be impractical if the load is to be run for long periods.

Motor Loads

Induction motors (that is, motors without brushes) require two to six times their running current on start up. The most demanding are those that start under load, for example, compressors and pumps. Of the capacitor start motors (typical in drill presses, band saws, etc.), the largest you can expect to run is ½ hp (the transfer relays are rated at 2 hp). Universal motors are generally easier to start. Since motor characteristics vary, only testing will determine whether a specific load can be started and how long it can be run.

If a motor fails to start within a few seconds or loses power after running for a time, it should be turned off. When the inverter attempts to start a load that is greater than it can handle, it will turn itself off after a few seconds.

Long Transfer Times The Freedom X may take a long time (~ 0.1–0.2 seconds) to transfer to Battery Mode when shore power is cut off while powering a motor load. Motor loads typically “freewheel” when power is removed (for example, a grinder) and causes a longer transfer time. The longer transition from shore power to inverter power may cause connected computers or other sensitive equipment to operate incorrectly. To avoid this effect, do not connect motor loads together with sensitive equipment to the inverter for power.

Specifications

NOTE: Specifications are subject to change without prior notice.

Physical Specifications	Freedom X 1000	Freedom X 2000
L × W × H	14.2" (360mm) × 10.6" (270mm) × 3.7" (95mm)	15.4" (390mm) × 10.8" (275mm) × 4.0" (102mm)
Net Weight	13.4 lbs (6.1 kg)	16.0 lbs (7.3 kg)

Environmental Specifications	Freedom X 1000	Freedom X 2000
Ambient Temperature: Operating Temperature Range Storage Temperature Range	-4 –140 °F (-20 –60 °C), with output derated above 104 °F (40 °C) -40 –158 °F (-40 –70 °C)	-4 –140 °F (-20 –60 °C), with output derated above 104 °F (40 °C) -40 –158 °F (-40 –70 °C)
Humidity: Operation/Storage	5–95% RH, non-condensing	5–95% RH, non-condensing

System Specifications	Freedom X 1000	Freedom X 2000
Transfer relay rating	30A surge, 24A continuous	30A surge, 24A continuous
Transfer time (shore to inverter)	<20 milliseconds ^a	<20 milliseconds ^a
Transfer time (inverter to shore)	<20 milliseconds with a 20-second delay	<20 milliseconds with a 20-second delay
Transfer voltage (shore to inverter)	<85 V and >140 V	<85 V and >140 V
Transfer voltage (inverter to shore)	<135 V and >90 V	<135 V and >90 V
Cooling	Fan, activated by any of the following: •High internal temperature •High AC output power	Fan, activated by any of the following: •High internal temperature •High AC output power

a. To change the AC Transfer time (mode), see “Adjusting Feature Settings in Configuration Mode” on page 44.

DC Input (For Inverting)	Freedom X 1000	Freedom X 2000
Operating voltage range	LBCO voltage ^a –18.0 VDC	LBCO voltage ^a –18.0 VDC
Maximum non-operating voltage	24 VDC	24 VDC
Nominal voltage	12.0 VDC	12.0 VDC
Nominal current at full load	100 ADC	192 ADC

AC Output (For Inverting)	Freedom X 1000	Freedom X 2000
Output voltage options	120, 110, 108 VAC	120, 110, 108 VAC
Continuous power	1000 W ^b @ 40 °C	2000 W ^b @ 40 °C
Continuous current	8.4 A	16.7 A
Surge power	2000 W	4000 W
Frequency	60 (or 50) Hz ^c	60 (or 50) Hz ^c
Wave shape	True Sine Wave	True Sine Wave
Peak efficiency	91%	91%
Full load efficiency	≥ 87%	≥ 87.5%

a. To set LBCO, see “Adjusting Feature Settings in Configuration Mode” on page 45.

b. Power derates to 85% when output voltage is set to 110/108 VAC.

c. To set the AC Frequency, see “Adjusting Feature Settings in Configuration Mode” on page 44.

Regulatory Approvals	Freedom X 1000	Freedom X 2000
EMC and Safety	ITS listed and c(ETL)us marked complies with CSA C22.2 No. 107.1, UL458 with marine supplement ^a ABYC E11, A20, A25, A31	
Electromagnetic compatibility	complies with FCC Part 15B, Class B emissions, and with Industry Canada ICES-003 Class B	

a. with accessory 808-1050 only

**Schneider Electric Solar
Inverters USA Inc.**

+1 800 670 0707

+1 408 987 6030

<http://www.xantrex.com>

975-0787-01-01

Printed in China