

SAKE WARMER UNIT

INSTRUCTION MANUAL

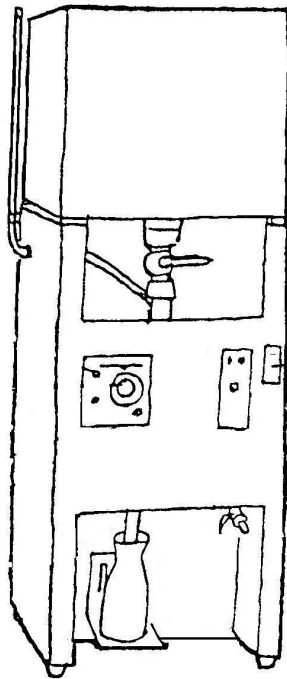

NEC-1

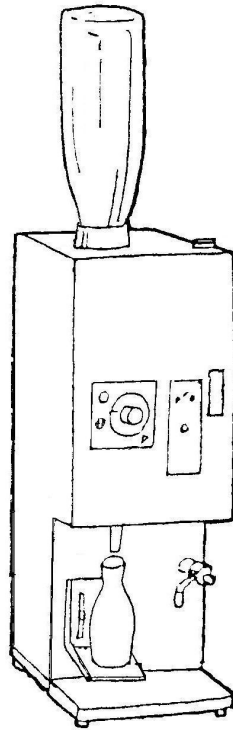

NE-1

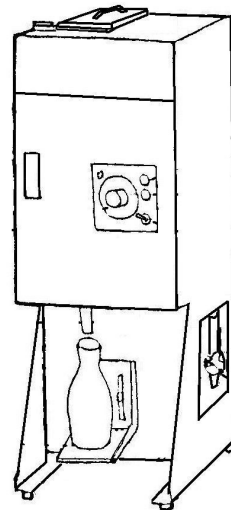

NST-1

Model: NEC-1

Model: NE-1

Model: NST-1

TAIKO ENTERPRISES CORP.

Manufacturer: SANSHIN CO.

Rev, B.5

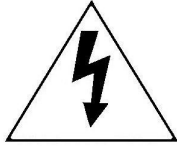

WARNING

**RISK OF FIRE OR ELECTRIC SHOCK
DO NOT OPEN**



WARNING: TO REDUCE THE RISK OF FIRE OR ELECTRIC SHOCK,

DO NOT REMOVE THIS COVER.

NO USER-SERVICEABLE PARTS INSIDE.

REPAIR SHOULD BE DONE BY AUTHORIZED SERVICE PERSONNEL ONLY.

SAKE WARMER UNIT

Thank you for purchasing this SAKE WARMER UNIT. SANSHIN is committed to customer satisfaction. This product is for the heating and dispensing of sake only. It is designed for indoor use.

Please read the instructions carefully and familiarize yourself before using this product.

Table of Contents

Safety Precautions	3
Accessories List & Control Panel	4
Models & Specifications	5~7
NEC-1 Cube Container Type Sake Warmer	5
NE-1 Bottle Holder Type Sake Warmer	6
NST-1 Tub Cup Type Sake Warmer	7
General Operation For All Models	8
Server Bottle Tray Adjustment	9
Clean the Sensor	10
Sake Warmer (model NEC-1) with Cube Container	10
Set Temperature Control	11
Set up Cube Container	12
Filling Server Bottle	12
Manual Switch for Dispensing	13
Finish Sake Warmer Unit	14
Cleaning Sake Warmer Unit & Nozzle	15
Sake Warmer (model NE-1) with Bottle Holder	16~17
Attaching Bottle holder and Strainer	16
Attaching Caper plug	16
Sake Warmer (model NST-1) with Tub Cup	18
Cleaning and rinse switch	19

Safety Precautions:

WARNINGS:

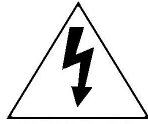

- The AC PLUG must be inserted directly into an outlet, **NEVER USE AN EXTENSION CABLE.**

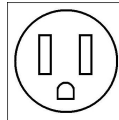

- Put the Sake Warmer Unit on a level, solid work surface. If the unit is unstable, attach an L-shaped support bracket to bottom side of the unit for attaching to the table.

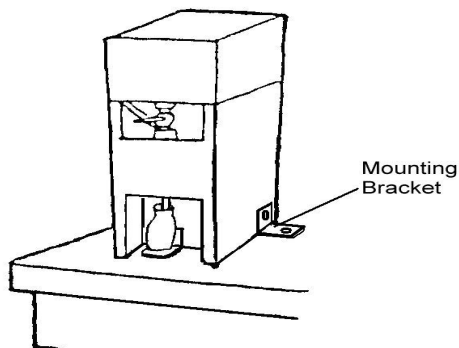

- Never use the Sake Warmer Unit near flammable materials or where flammable vapors are present.
- **Check the water level indicator before turning on this product. If the water level is too low, the Sake Warmer Unit may malfunction or the life of the unit will be shortened.**
- **Do not disassemble this unit as there are no serviceable parts inside. Please contact your local distributor for servicing.**

CAUTIONS:



- Do not operate this product if the unit has been damaged.
- This product is designed for warming sake (Japanese rice wine) only.
- To prevent injury during operation, avoid contact with the hot sake.

Accessories

Model :	Funnel	Caper	Hose	Mounting Bracket Screw	Instruction Manual
NEC1	1	0	1	2 (M) +4 (S)	1
NE1	1	2	1	2 (M) +4 (S)	1
NST1	1	0	1	2 (M) +4 (S)	1

Additional Accessories for NE-1

Bottle Holder

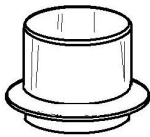

Strainer



NEC-1, NE-1 Control Panel

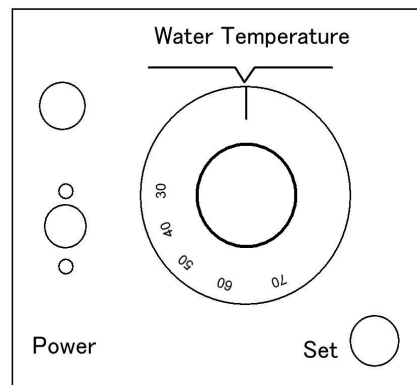

NST-1 Control Panel

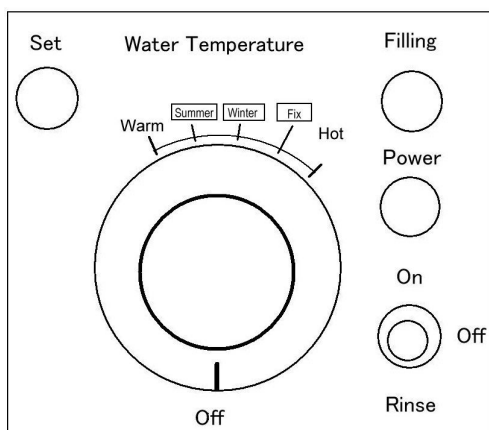

NEC1,NE1 sub panel

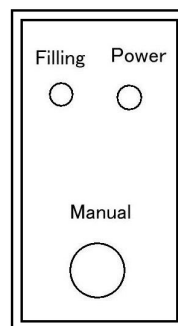

Water Level

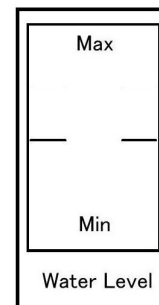

MODEL & SPECIFICATIONS:

NEC-1 CUBE CONTAINER TYPE SAKE WARMER

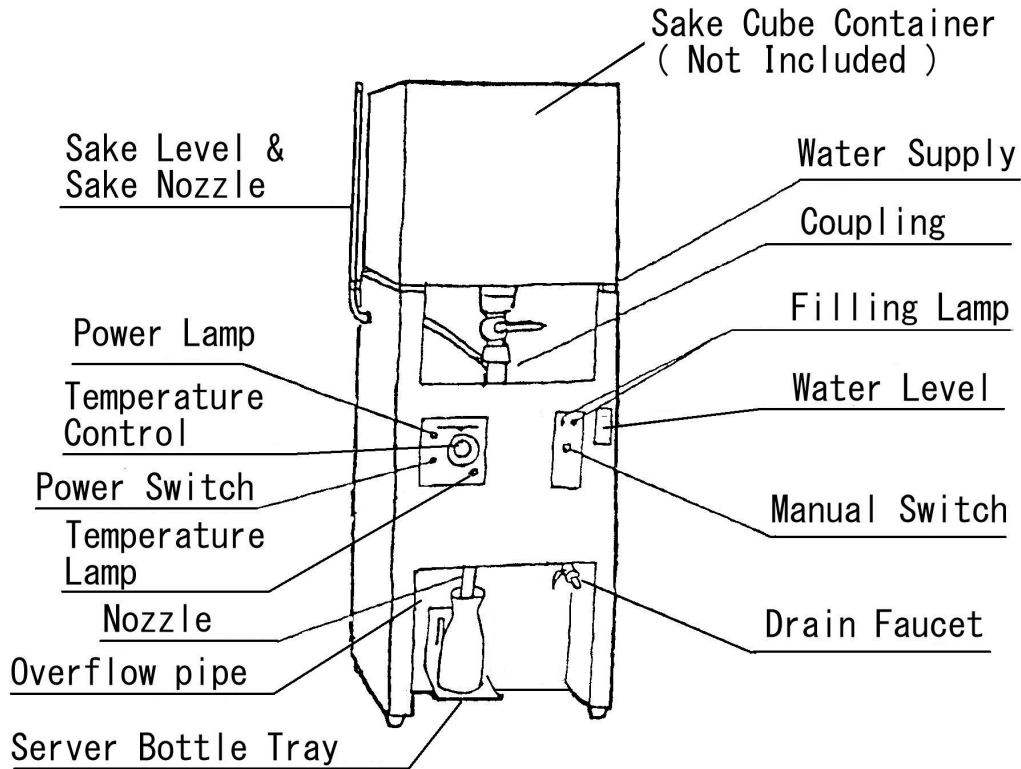

Specifications:

Power Consumption: 120V, 50Hz/60Hz, 1KW.

Sake Supply Type: Cube Container , 4.5L

Dimensions: W 9-7/8" x D 11-1/16" x H 23" (W280 x D280 x H675mm)

Weight: approx, 24.2 lb. (11kg)

Accessories: See Accessories list.

NE-1 BOTTLE HOLDER TYPE SAKE WARMER

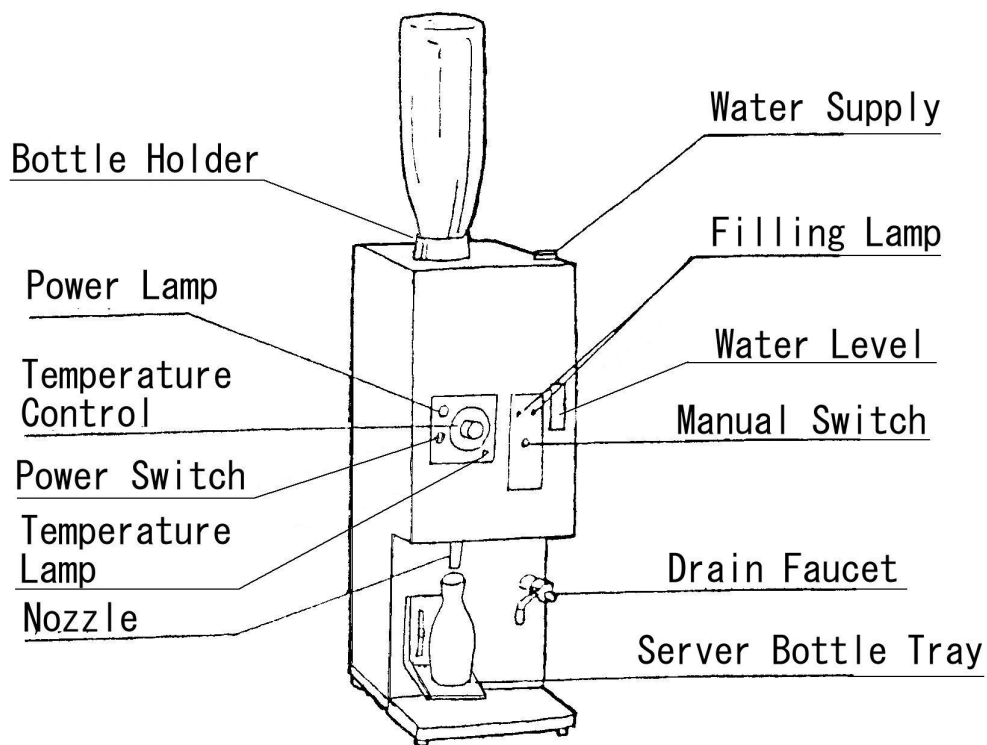

Specifications:

Power Consumption: 120V, 50Hz/60Hz, 1KW.

Sake Supply Type: Sake Bottle

Dimensions: W 7-15/16" x D 11-1/16" x H 23-15/16" (W200 x D280 x H680mm)

Weight: approx, 19.8 lb. (9kg)

Accessories: See Accessories list & additional accessories (bottle holder, strainer).

NST-1 TUB CUP TYPE SAKE WARMER

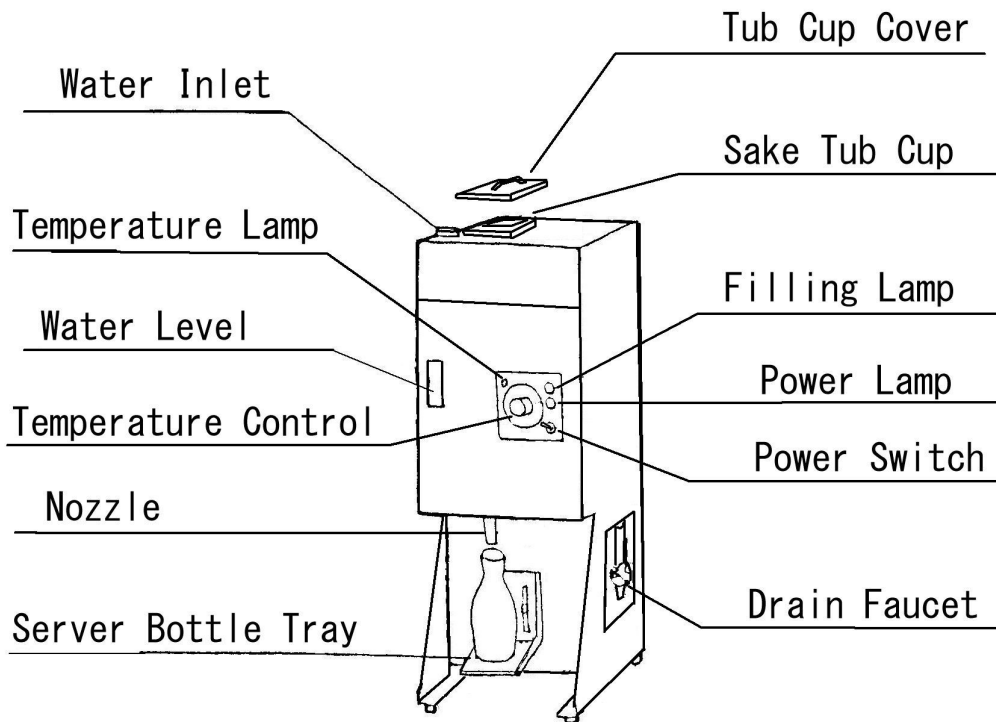

Specifications:

Power Consumption: 120V, 50Hz/60Hz, 500W.

Sake Supply Type: Tub Cup

Dimensions: W 6-5/16" x D 11-3/4" x H 20-1/4" (W190 x D320 x H550mm)

Weight: approx, 12.5 lb. (5.7kg)

Accessories: See Accessories list.

GENERAL OPERATION FOR ALL MODELS:

1. Placing Sake Warmer Unit.

- Place Sake warmer unit on a flat, level table.
- DO NOT use an extension cable. Plug this Unit directly into a wall outlet.

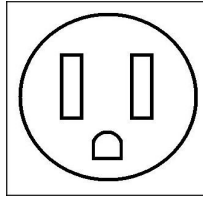
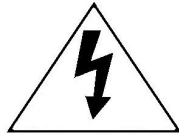

2. Water Supply for Sake warmer Unit.

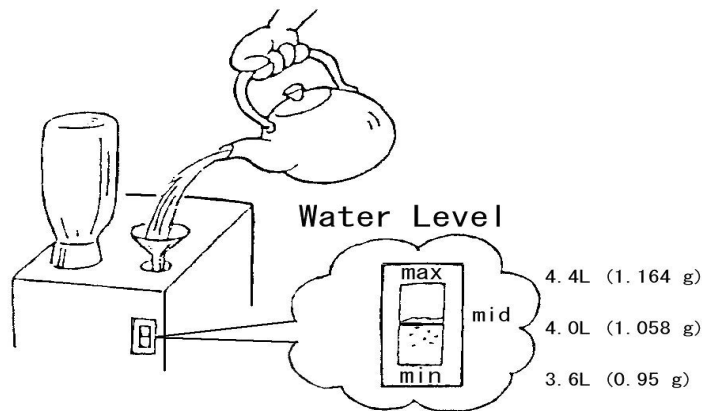

- Remove the water inlet plug at the top, right corner.
- Add enough water to the tank to reach the desired level.
- There is a water level indicator at the front of the unit below the water inlet. Verify the water level in the tank. Optimal water level is at the upper white line at the middle of the water level indicator (4.0L, or 1.058 gal).
- Water in the tank should be replaced with new water at least once a month.
- Attach the accessory tube to the drain faucet, prepare the drain basket, and open the drain faucet.

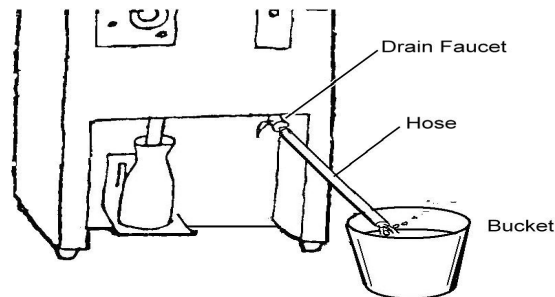

- Please pay special attention to the overflow water coming out from overflow exit tube, below the front corner. Avoid contact with the hot water.
- If the tank is empty, a protection circuit will turn power off automatically.
In order to reset the protection function, turn power off immediately. Put water in the tank at a suitable level and turn the power back on.
- Clean the nozzle once a day, wash it, wipe with a soft cotton.

3. Server Bottle Tray adjustment

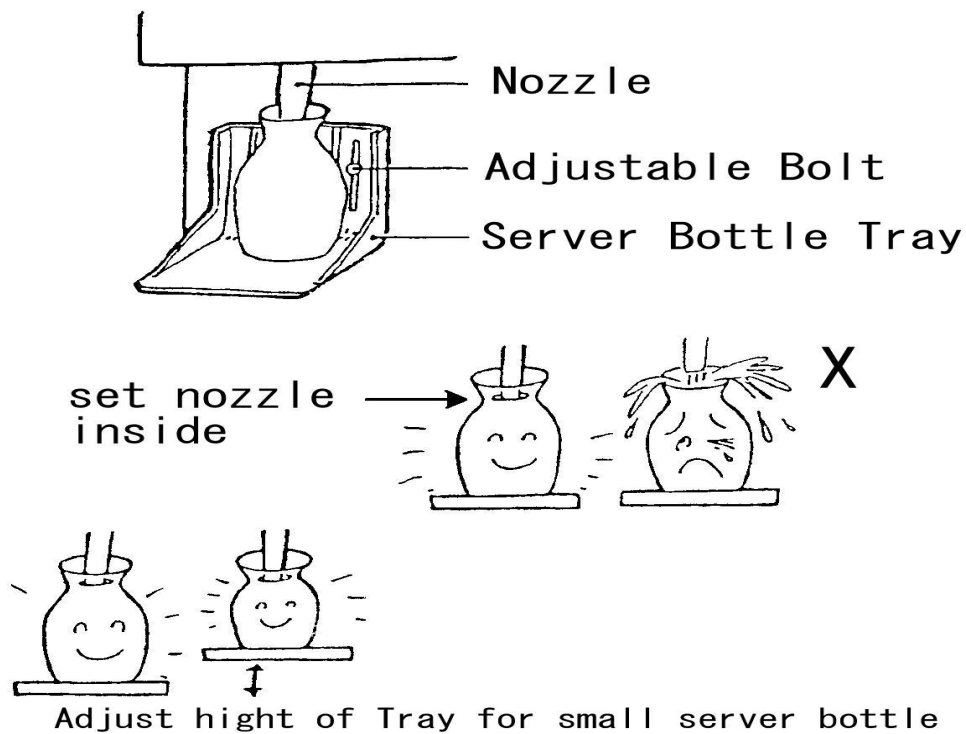

- The Sake Warmer Nozzle has a Sake Level Detection Sensor at the top of the nozzle.
- Place a Server bottle on the Server bottle Tray and adjust its height for the appropriate level of sake in the bottle.
- The Nozzle must be inside of server bottle.
- The Hot sake will stop filling when the hot sake reaches the sensor at the top of the nozzle.
- There are two different height adjusting holes. The lower holes for long server bottles and the higher holes for short server bottles.

4. Clean the Sensor

Clean the sensor at nozzle with tooth brush once a month.

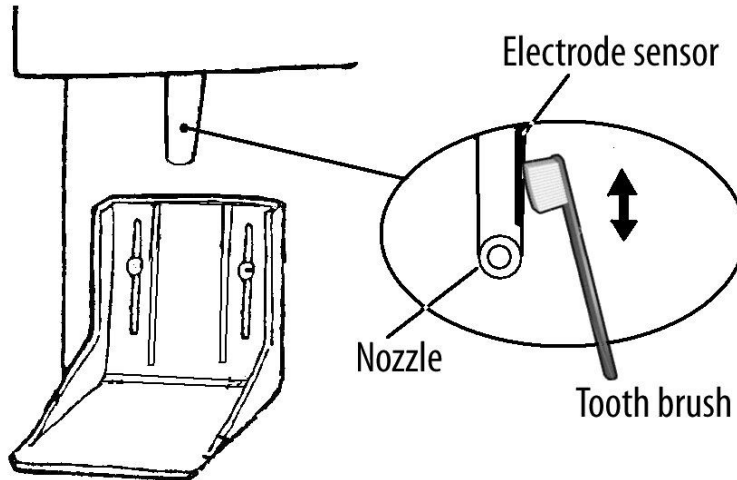

5. Sake Warmer (model NEC-1) with CUBE CONTAINER

- This sake warmer is designed for CUBE CONTAINER Type Sake.
- The Sake Level Indicator Tube is located at the top left side. Please set the Level Indicator Tube in the upper position at the metal clip.
- The end of the Indicator Tube is attached by a silicon fitting. You can use the tube's lower position to fill with cold sake. Squeeze the top silicon fitting to adjust for filling with cold sake.

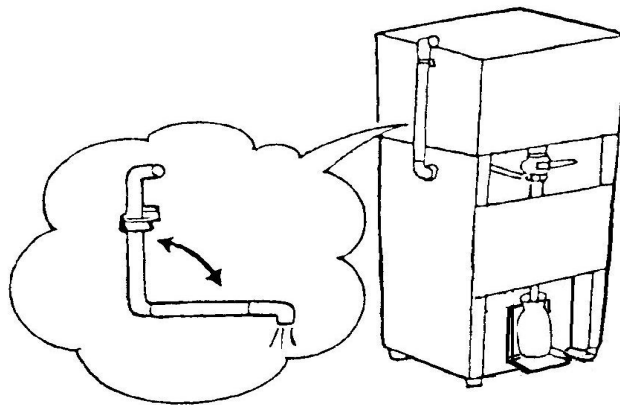

6. Normal Operations:

- Please make sure a power switch of the sake warmer is in the OFF position before applying AC power. AC plug must be plugged directly into the wall outlet.

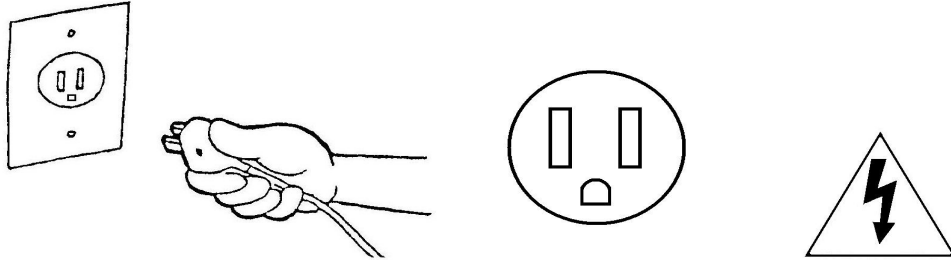

- DO NOT USE an extension cable.
- **Check the water level indicator before turning on this product.**
- The Green Power Indicator turns on when the Power Switch is in the On position.

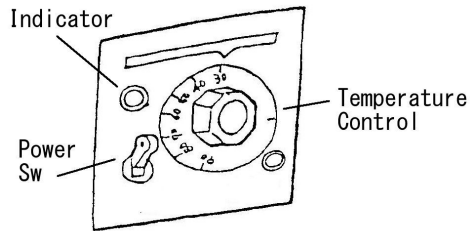

7. Set Temperature Control

- Set the temperature control knob at the desired position. When the water temperature reaches the adjusted level, the temperature indicator turns off (model NEC-1, NE-1 apply 30~70 degree C dial gauge, model NST-1 apply warm and hot dial gauge) See Page 4.

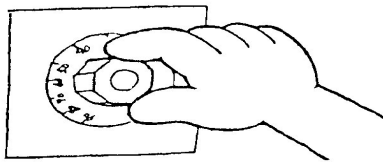

- If serving a lot of sake, the temperature level adjustment should be a bit higher in order to maintain the proper temperature.
- Turn the Water temperature control knob clockwise to increase the temperature and counter-clockwise reduce the temperature.
- The Temperature adjustment is affected by the ambient surroundings. It may need re-adjusting for different seasons.

8. Setup CUBE CONTAINER

- The CUBE CONTAINER has screw, bayonet mount. Before attaching the sake warmer Coupler, please note the lever on the side of coupler. Make sure this lever is in the CLOSE position.
- After connecting the CUBE CONTAINER with the Coupler, place the CUBE CONTAINER on top of the Sake Warmer Unit.

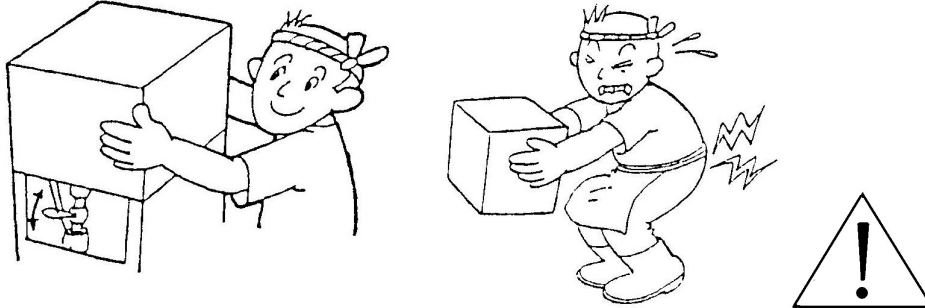

- Since the CUBE CONTAINER can weigh over 40 lbs. Take special precautions as with handling any heavy object. Improper lifting of the container can cause bodily injury.

9. Filling Server Bottle:

- There is a nozzle at lower front of the unit. To operate, the server bottle must be brought to this nozzle. This nozzle controls the filling of the bottle.

NOTE: When the nozzle position is straight, filling begins into server bottle.

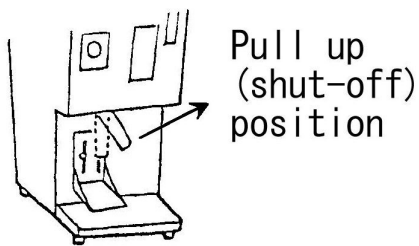

Coupling On (open) Position

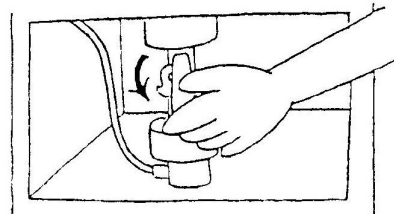

- Please make sure the Coupling lever is in the OPEN position.
- THE COUPLING LEVER ONLY OPENS WHEN THE NOZZLE IS IN A STRAIGHT POSITION. THIS AVOIDS A REVERSE FLOW OF SAKE FROM THE INDICATOR TUBE.

- Turn on the POWER switch and the Green Power Lamp turns on.
- Insert the nozzle into a server bottle. Push back the server bottle until the nozzle is in a straight position. Leave the server bottle on the tray while it fills (When nozzle is in a straight position, the server bottle begins filling with sake).

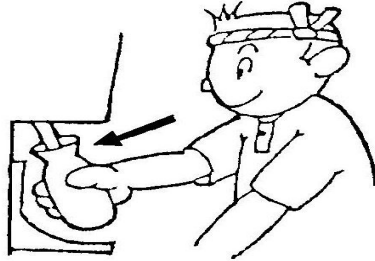

- While filling hot sake into the server bottle, the top left filling lamp turns on.
- When the filling lamp turns off, bring the server bottle forward until the nozzle is in the off position.

10. Manual switch for dispensing

- There is a switch below filling lamp. Press and hold this switch to fill hot sake manually.

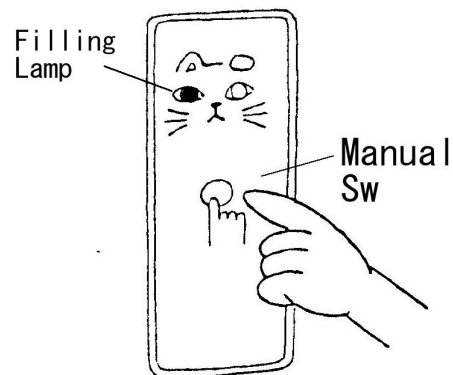

11. Finish Sake Warmer Unit:

- When finished serving sake, you must CLOSE the Coupling lever. There is no more sake in the warmer tube from CUBE CONTAINER.

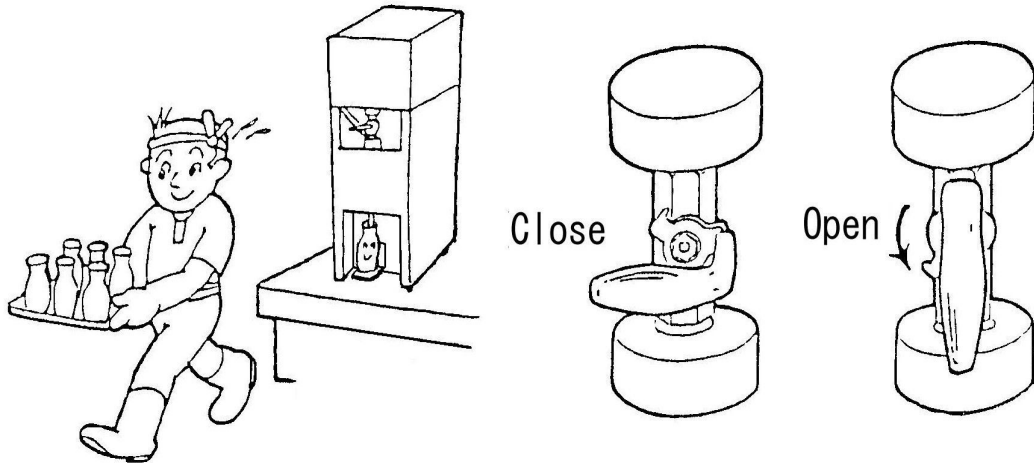

- After Closing the Coupling Lever, if sake remains in the warmer tube, it must be drained.
- After draining, turn the Power Switch Off.

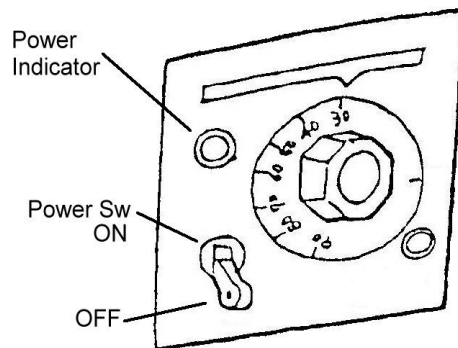

12. Cleaning Sake Warmer Unit:

- Use the Empty CUBE CONTAINER and remove its top. Put hot water into the container.

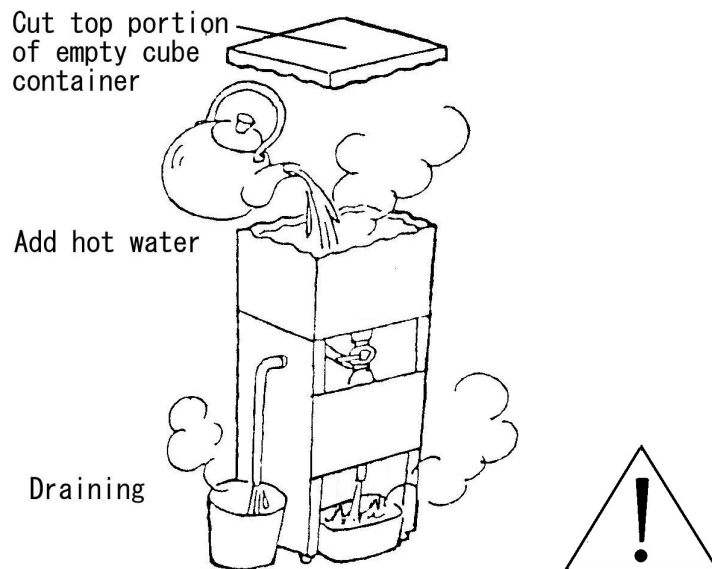

- The Sake Level Indicator Tube must be set to the lower position for Cleaning.
- Clean the nozzle once a day, wash it, wipe with a soft cotton.

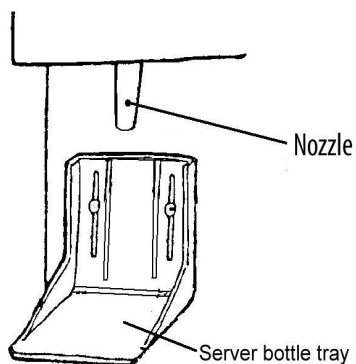

Sake Warmer (model NE-1) with Bottle Holder

Attaching Bottle Holder and Strainer

- Before using sake warmer, attaching bottle holder and placing strainer.

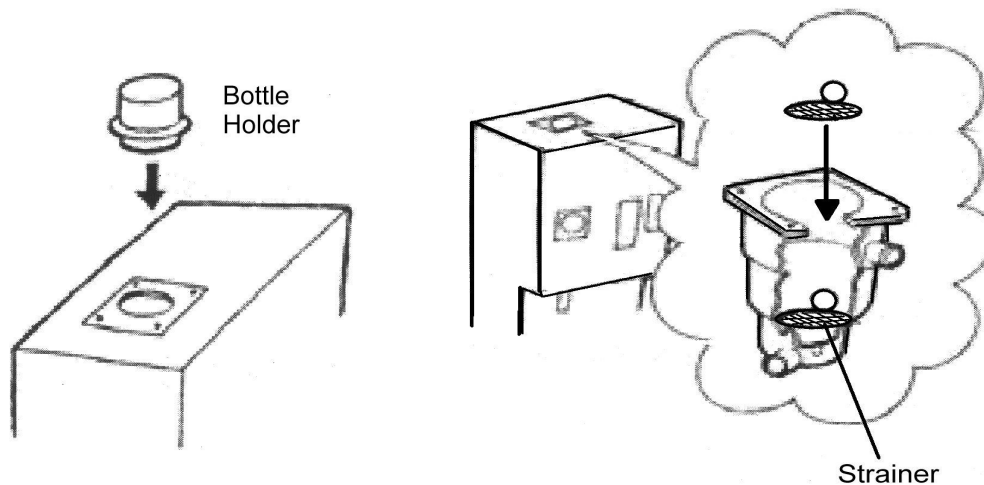

Setup Sake Bottle:

- Before attaching the **Caper Plug** on the Sake Bottle (Original sake bottle) mouth, make sure there is no foreign material inside. After attaching the caper plug, turn the Sake Bottle upside-down into the SAKE BOTTLE HOLDER.

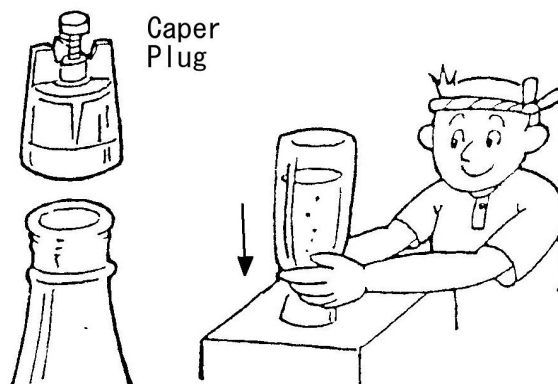

Normal Operations:

- **Check the water level indicator before turning on this product.**
Same as Sake Warmer (model NEC-1) with CUBE CONTAINER

Filling Server Bottle:

Same as Sake Warmer (model NEC-1) with CUBE CONTAINER

Finish Sake Warmer Unit:

- When finished serving sake, remove the sake bottle from the holder.
- The Caper Stop Plug will close the sake bottle mouth automatically.

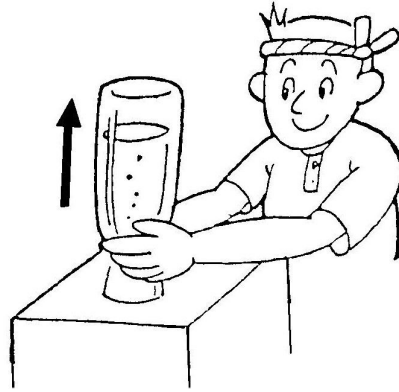

- After removing the sake bottle, if some sake remains in the warmer tube it must be drained.
- After draining, Turn the Power Switch Off.

Cleaning Sake Warmer Unit:

- After removing the sake bottle, Add hot water into the holder cup for cleaning the tube and nozzle.

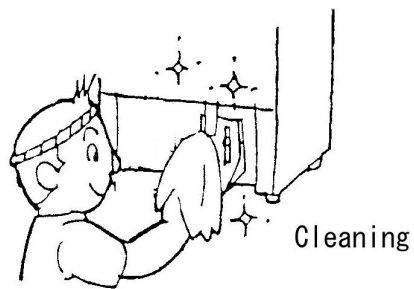
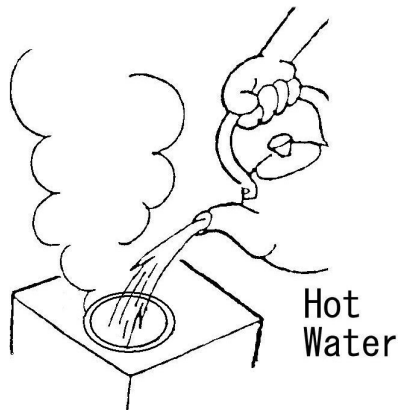

- **Clean Sake Warmer Unit:** wipe with a soft cotton cloth daily.

Sake Warmer (model NST-1) with TUB CUP

Set Up Sake into TUB CUP:

- Open Top Tub Cover and add enough sake to tub to reach the inside fill line.
- Close the Tub Cover.

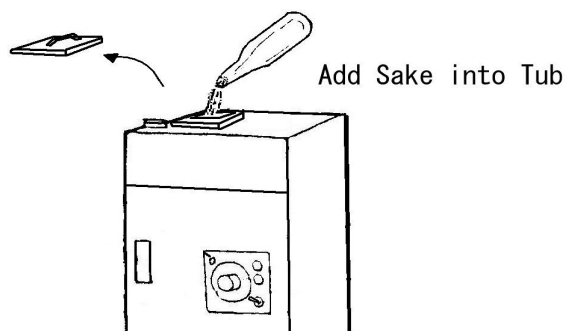

Normal Operations:

- **Check the water level indicator before turning on this product.**

Same as Sake Warmer (model NEC-1) with CUBE CONTAINER

Filling Server Bottle:

Same as Sake Warmer (model NEC-1) with CUBE CONTAINER

Finish Sake Warmer Unit:

- Make sure TUB CUP is empty.
- Some sake remains in the warmer tube and it must be drained.
- After draining, Turn the Power Switch Off.

Cleaning Sake Warmer Unit:

- After all sake is drained from the TUB CUP, Add hot water (around 160~175 degree F) in the TUB CUP for cleaning the tube and nozzle.

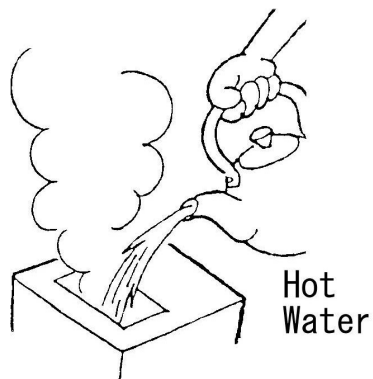

- This model has a Cleaning Switch. PUSH DOWN and HOLD the Power Switch to enter Cleaning mode (rinse).

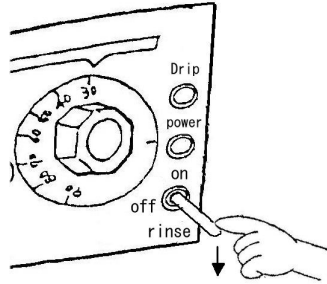

- Clean Sake Warmer Unit: wipe with a soft cotton cloth daily.

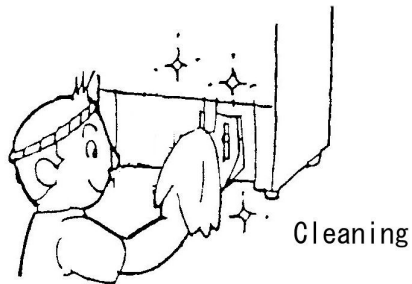

Manufacturer: SANSBIN CO

1-2-4 Nakamura-kita, Nerima, Tokyo 176-023 JAPAN

PH# 339700943

Distributor: TAIKO ENTERPRISES CORP

1467 W 178th street, Gardena CA 90248

PH# 310-715-1888

Electrical Rating: Single Phase, 120V, 50/60Hz, 1000W(NEC-1,NE-1), 500W(NST-1)

Heating Method: Indirect Heating via Hot Water bath.

Made in Japan

MODEL.NO: _____

SERIAL.NO: _____

PURCHASE DATE: _____