

### OCTA SERIES TUBES INSTALLATION INSTRUCTIONS

VEHICLE APPLICATION(S):

2019 →  
FORD RANGER  
CREW & SUPERCAB



LHS SHOWN, RH OPPOSITE

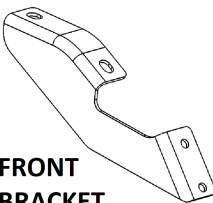
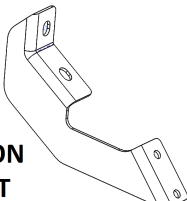
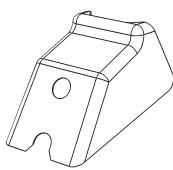
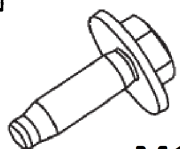
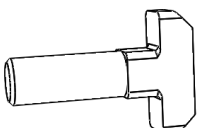
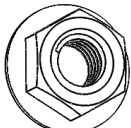

Components - Componentes - Composants

<p><b>A</b></p>  <p>FRONT BRACKET</p>	<p><b>B</b></p>  <p>COMMON BRACKET</p>	<p><b>C</b></p> 	<p><b>D</b></p>  <p>M10</p>
<p><b>E</b></p>  <p>M8</p>	<p><b>F</b></p>  <p>M8</p>		

TOOLS REQUIRED  
HERRAMIENTAS NECESARIAS  
OUTILS NÉCESSAIRES

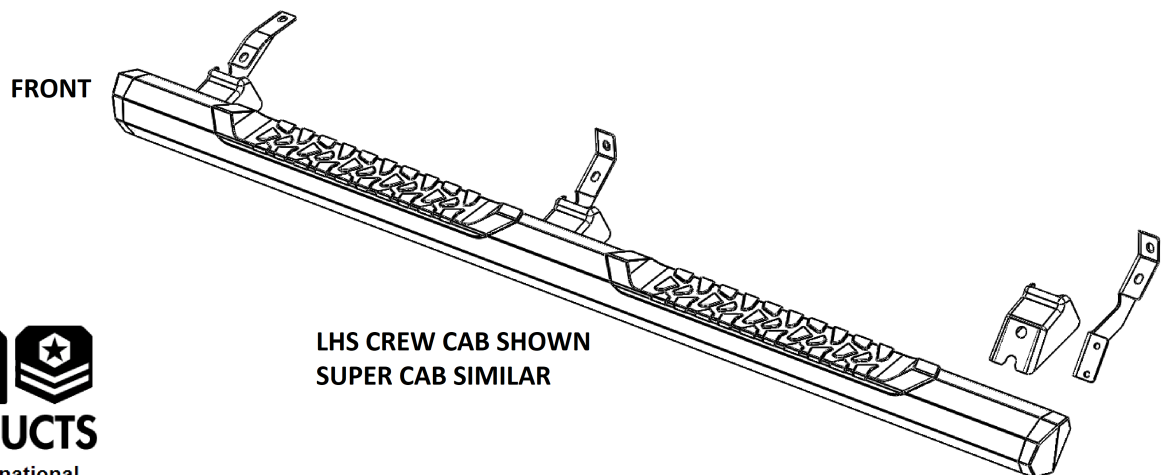
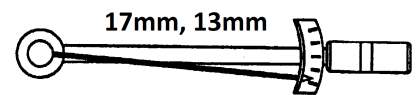
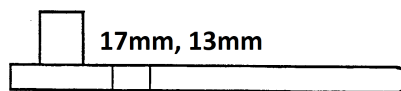

1

PART NO'S: 300097-300100

From underneath the truck, remove and discard plastic plugs at bracket mounting locations to expose threaded holes in inner rocker.

CREW CAB DRIVER SIDE SHOWN

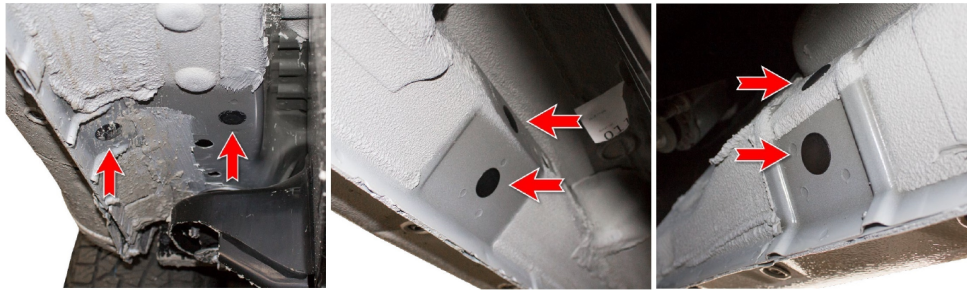

FRONT

MIDDLE

REAR

2

Using M10 SEMS bolts (Item D) attach front bracket (Item A) at front location, and attach common brackets (Item B) at middle and rear location.

Install ONLY FINGER TIGHT at this time.

3

On each bracket, set in place a bracket cover (Item C). It will be held in place in step 4.

Insert into each bracket hole a M8 T-bolt (Item E) and from below **just start** to thread on a M8 Flange nut (Item F). Leave very loose at this time.

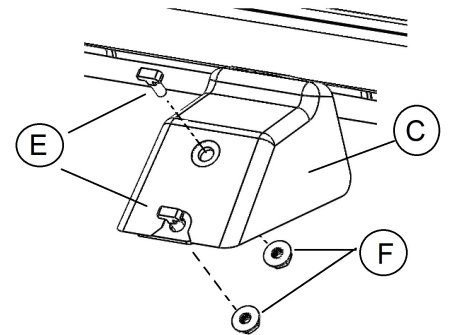

4

Set OCTA Series Tube in place, being sure to align slots over top of t-bolt fasteners.

Position board fore-aft along brackets for best appearance.

**PUSH UP AND TURN**, M8 nuts from below to engage the t-bolt across t-bolt slot. Finger tighten at all locations.

Double check engagement at each slot by lifting up on board. It should be secure.

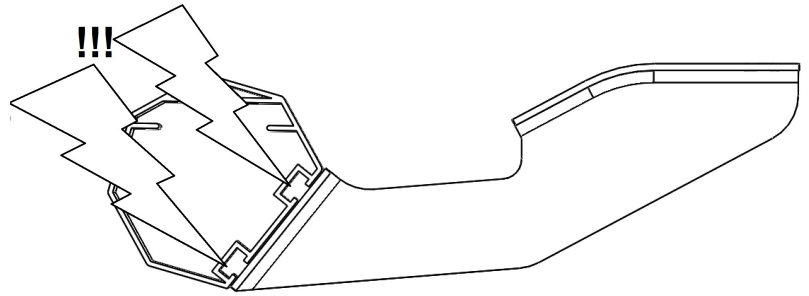

**CAUTION!! - Be sure to engage t-bolts into slots. Push UP and TURN to tighten. Verify t-bolts are engaged before torquing fasteners.**

