



PART No. HW363612SSHK

for more information visit

www.hammondmfg.com

Data subject to change without notice

Isometric drawing Not to Scale

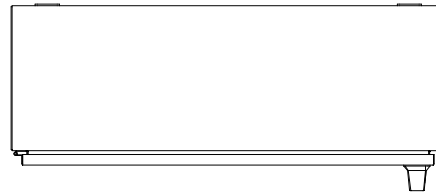

TOP VIEW

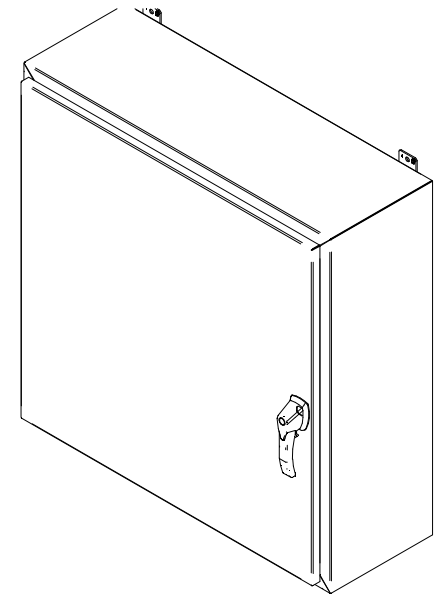

ISOMETRIC VIEW

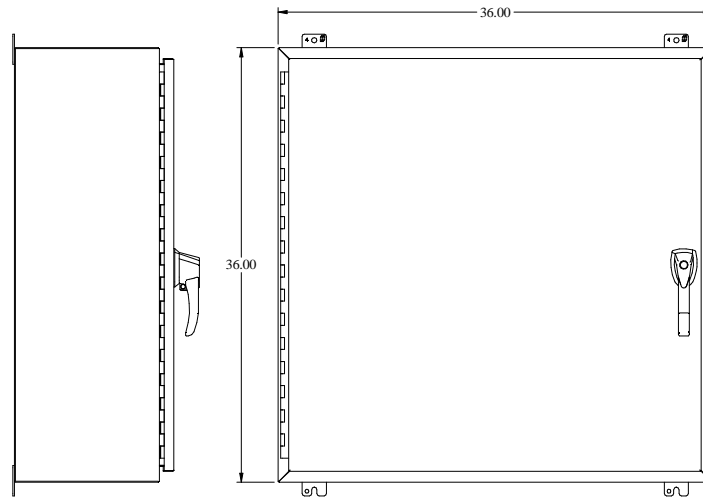

SIDE VIEW

FRONT VIEW

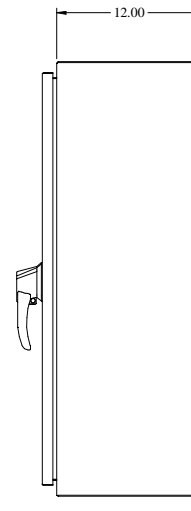

SIDE VIEW

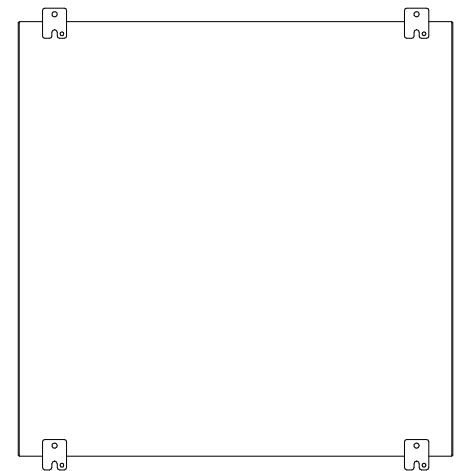

REAR VIEW



BOTTOM VIEW