

PART No. HW24308SSHK

for more information visit  
[www.hammondmfg.com](http://www.hammondmfg.com)

Data subject to change without notice

Isometric drawing Not to Scale



TOP VIEW

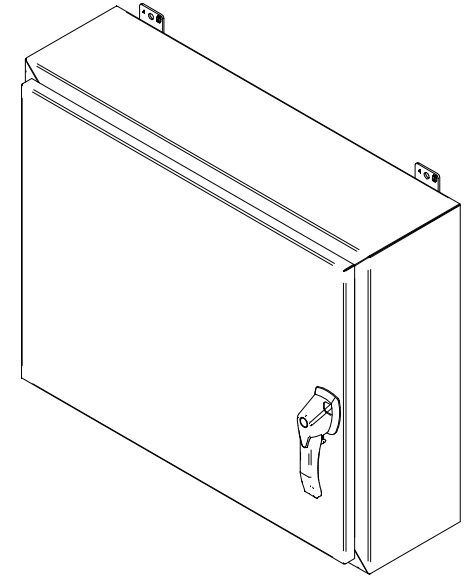

ISOMETRIC VIEW

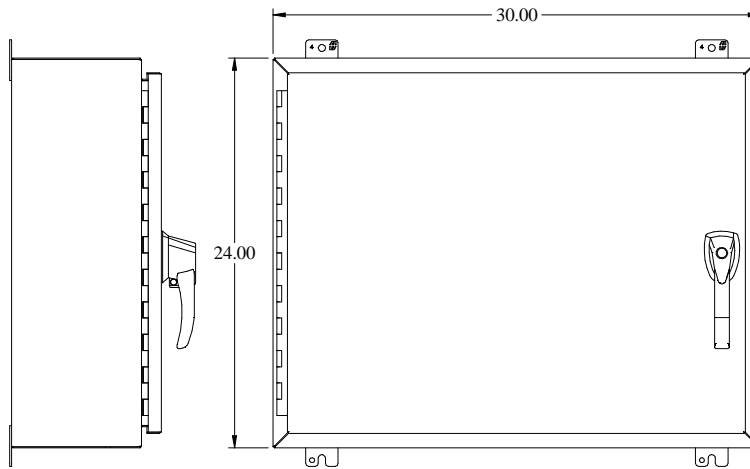

SIDE VIEW

FRONT VIEW

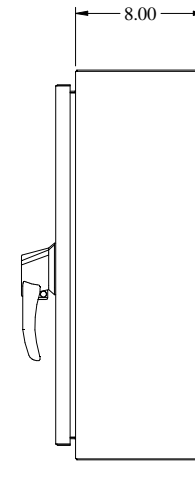

SIDE VIEW

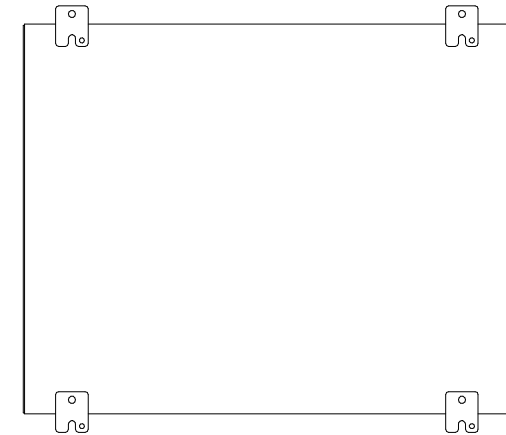

REAR VIEW

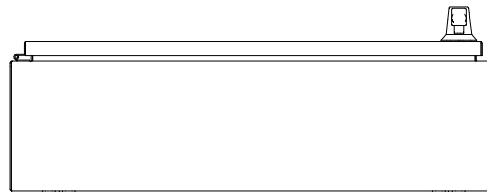

BOTTOM VIEW