

AR1084CHSSL



Sample image

Order symbol : AR1084CHSSL

EAN : 6418074066732

Product nr : 8561100

Description : PC Enclosure

Remarks : Hinged opaque cover w/S.S. Lockable latch

Including : Hinged cover. Base with 10-32 brass inserts, latched cover with formed in place PUR gasket, stainless hinge pin. Quick release latches. Enclosure mounting foot kit. Accessory 10-32 screws for panel mounting.

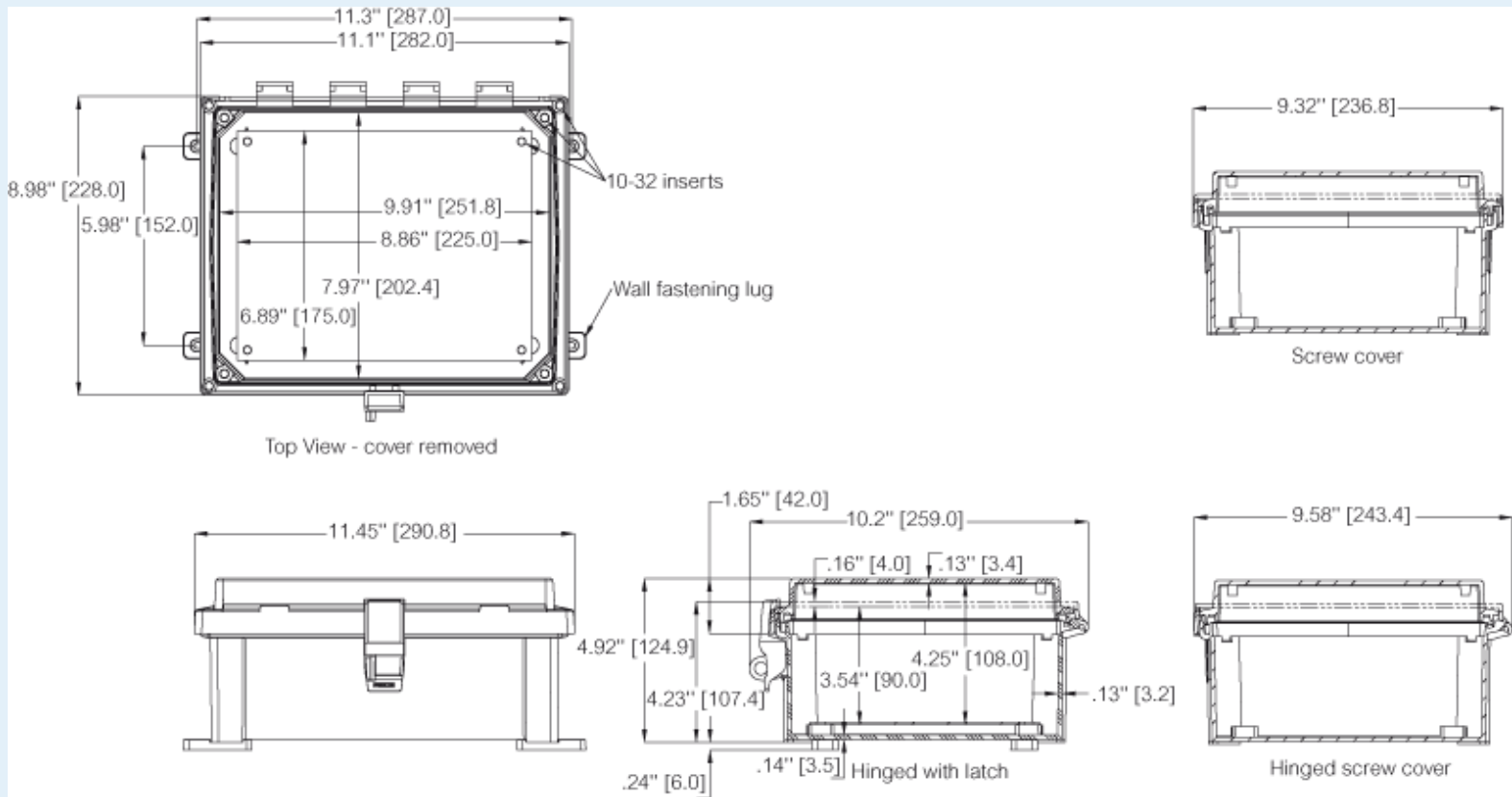

Dimensions : **Height** **Width** **Depth**

Accessories :

- ASPHK10 Swing Panel Kit w/o Panel
- ABP108 Painted Steel Back Panel

Materials :

Material :	Polycarbonate
Base colour :	RAL_7035
Cover colour :	RAL 7035 -light grey
Gasket material :	Polyurethane

ADFP108	Dead Front Panel w/ screws
ASP108	Aluminum Swing Panel
ASPK108	Swing Panel Kit incl. Panel
ALBP108	Aluminum Back Panel
AMFL8	8" Mounting Flange Set
APBP108	PVC Back Panel

Temperatures :

Temperature °C (short term) :	-40 ... 140
Temperature °C (continuous) :	-40 ... 80
Temperature °F (short term) :	-40 ... 250
Temperature °F (continuous) :	-40 ... 175

Ratings :

Ingress protection (EN 60529):	IP66; IP67;
Impact Resistance (EN 62262):	IK09;
electrical_insulation :	Totally insulated
Halogen free (DIN/VDE 0472, Part 815) :	Yes
UV resistance :	UL 508
Flammability Rating :	UL 508
Glow Wire Test (IEC 695-2-1) °C :	960C
NEMA Class	NEMA__4_4X_6_6P_12_13

Certificates :

ARCA_CertificateofCompliance