

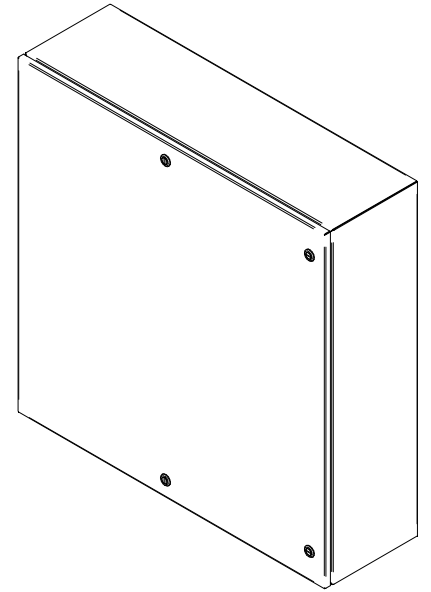

PART No. EN4SD363610SSR

for more information visit  
[www.hammondmfg.com](http://www.hammondmfg.com)  
Data subject to change without notice

Isometric drawing Not to Scale



ISOMETRIC VIEW

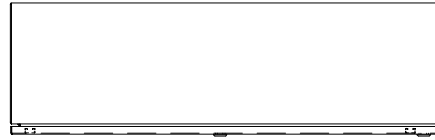

TOP VIEW

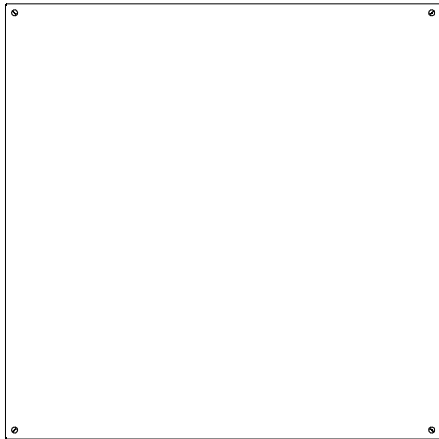

BACK VIEW

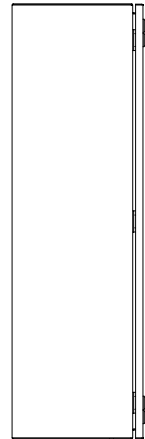

LEFT SIDE VIEW

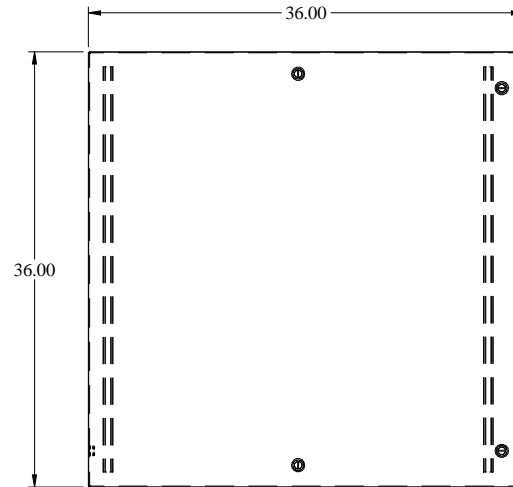

FRONT VIEW

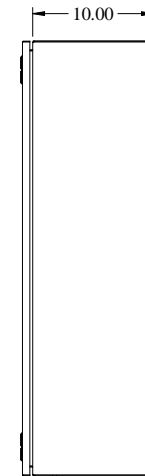

RIGHT SIDE VIEW

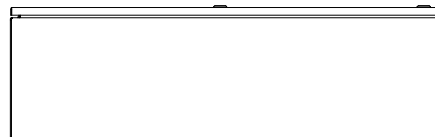

BOTTOM VIEW