

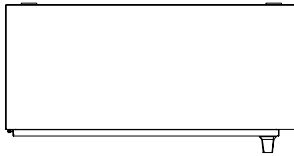

**PART No. 1447SJ16HK**  
 For more information visit  
[www.hammondmfg.com](http://www.hammondmfg.com)  
 Data subject to change without  
 notice™  
 ©M  
 Isometric drawing Not to Scale

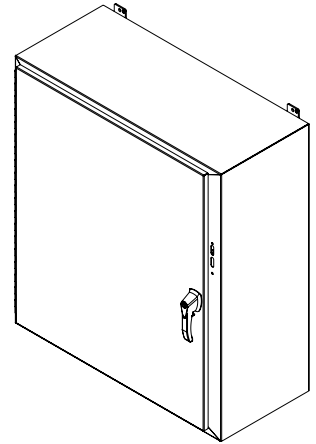

**TOP VIEW**



**ISOMETRIC VIEW**

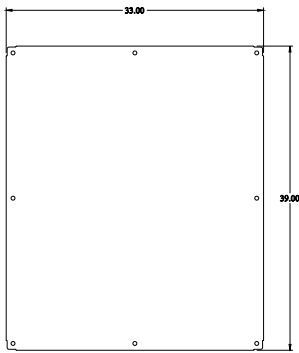

**INNER PANEL VIEW**

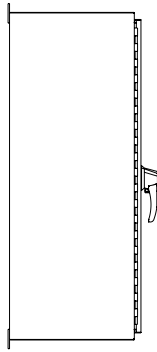

**LEFT SIDE VIEW**

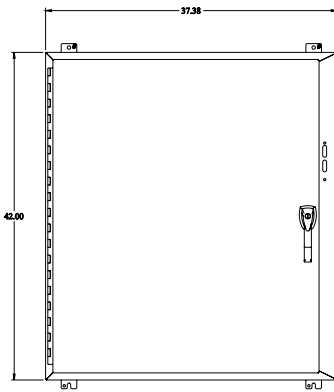

**FRONT VIEW**

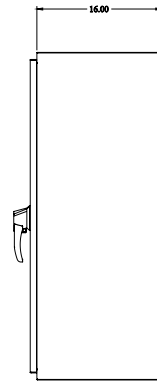

**RIGHT SIDE VIEW**

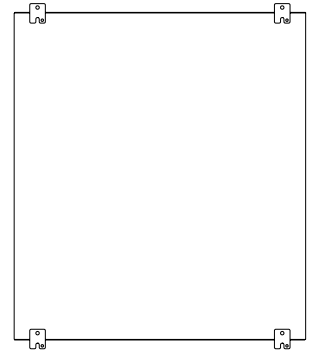

**REAR VIEW**

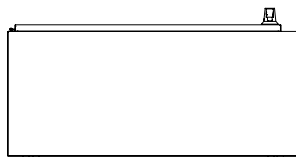

**BOTTOM VIEW**