

PART No. 1447SJ10HK
 for more information visit
www.hammondmfg.com
 Data subject to change without
 notice
 M
 Isometric drawing Not to Scale

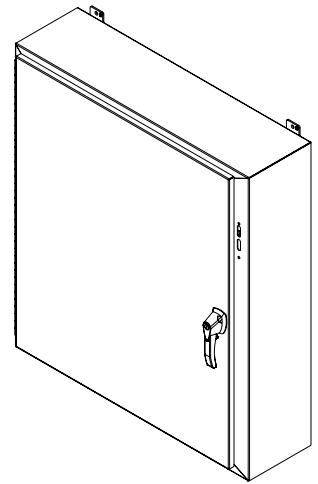

ISOMETRIC VIEW

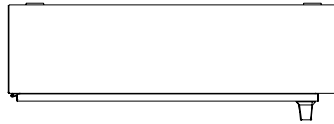

TOP VIEW

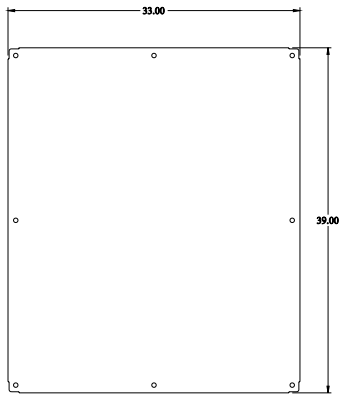

INNER PANEL VIEW

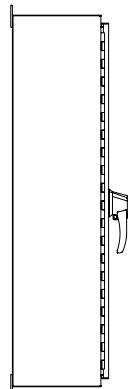

LEFT SIDE VIEW

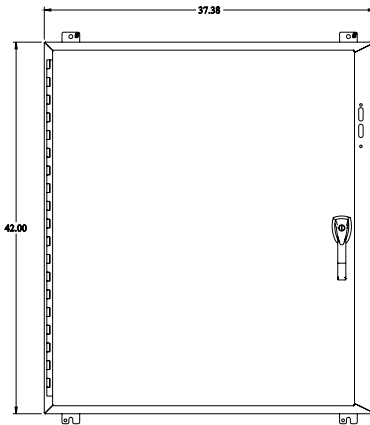

FRONT VIEW

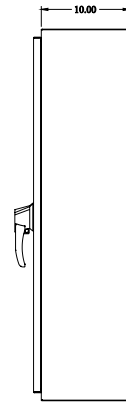

RIGHT SIDE VIEW

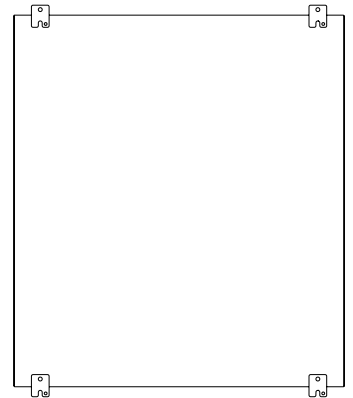

REAR VIEW

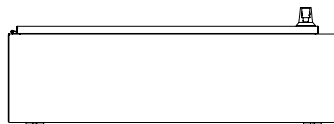

BOTTOM VIEW