



**PART No. 1447SH16HK**

for more information visit

[www.hammondmfg.com](http://www.hammondmfg.com)

Data subject to change without

notice™

™

Isometric drawing Not to Scale

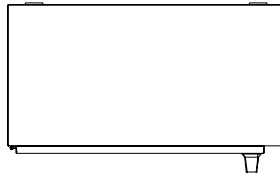

**TOP VIEW**

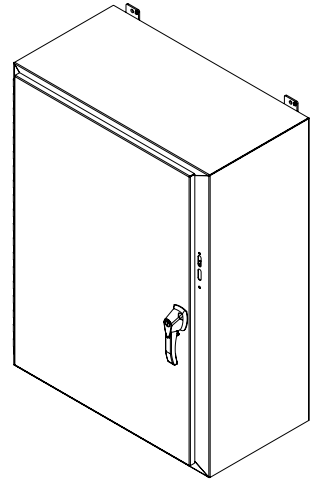

**ISOMETRIC VIEW**

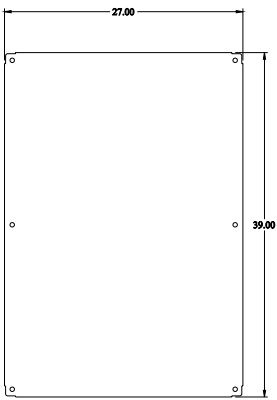

**INNER PANEL VIEW**

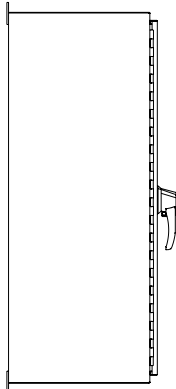

**LEFT SIDE VIEW**

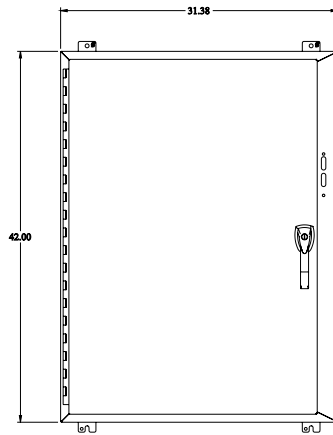

**FRONT VIEW**

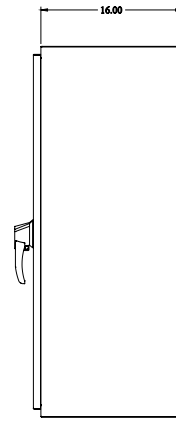

**RIGHT SIDE VIEW**

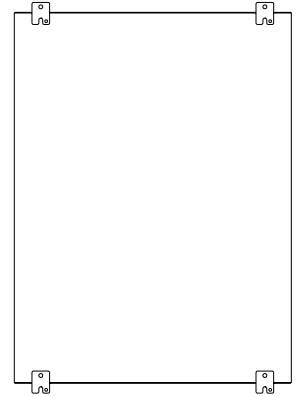

**REAR VIEW**

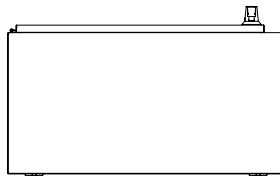

**BOTTOM VIEW**