

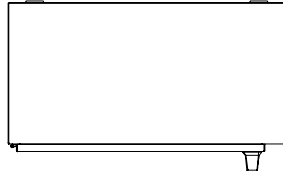

PART No. 1447SG16HK
 for more information visit
www.hammondmfg.com
 Data subject to change without
 notice™
 144
 Isometric drawing Not to Scale

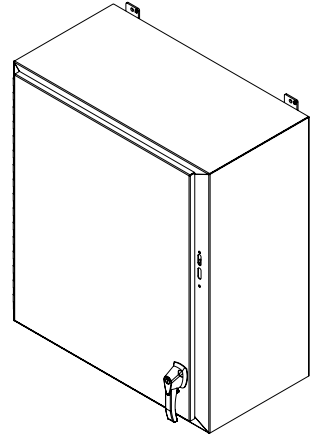

TOP VIEW

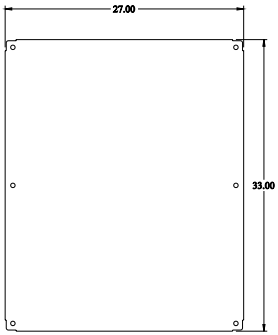

ISOMETRIC VIEW



INNER PANEL VIEW

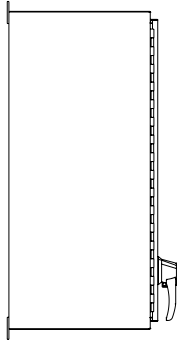

LEFT SIDE VIEW

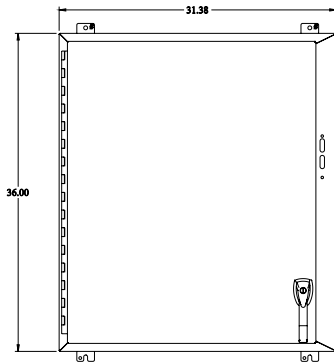

FRONT VIEW

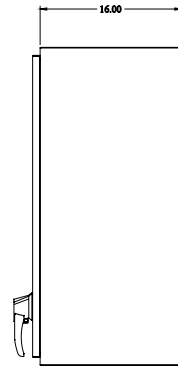

RIGHT SIDE VIEW

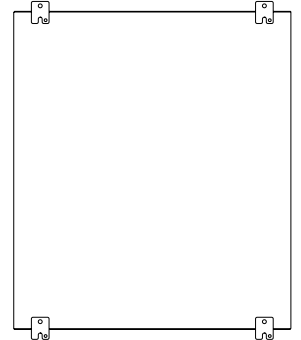

REAR VIEW

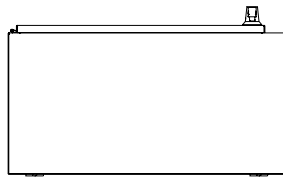

BOTTOM VIEW