

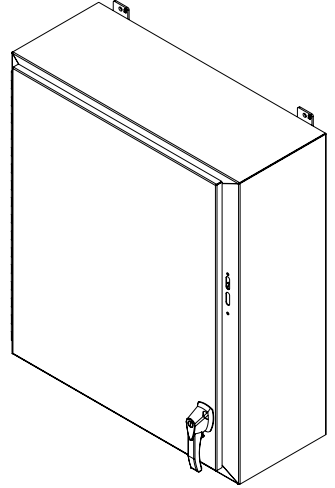

PART No. 1447SG12HK

for more information visit
www.hammondmfg.com

Data subject to change without
notice*
*M
Isometric drawing Not to Scale



ISOMETRIC VIEW

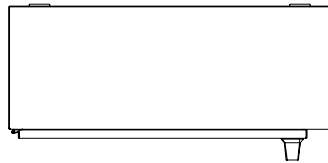

TOP VIEW

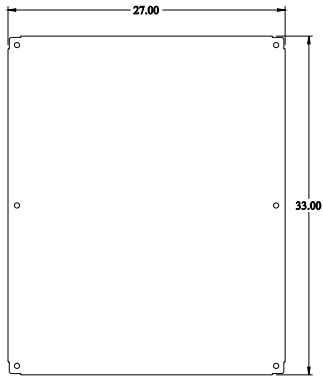

INNER PANEL VIEW

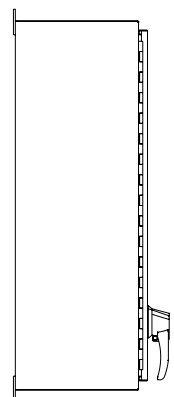

LEFT SIDE VIEW

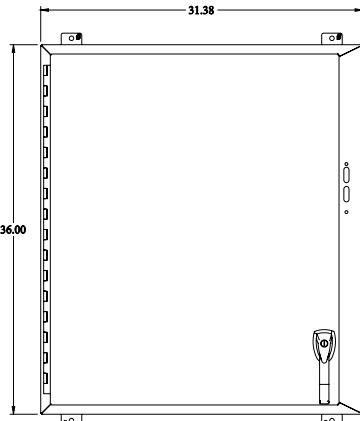

FRONT VIEW

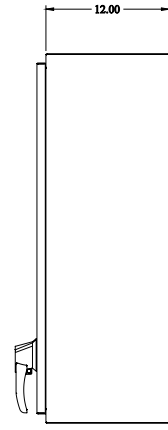

RIGHT SIDE VIEW

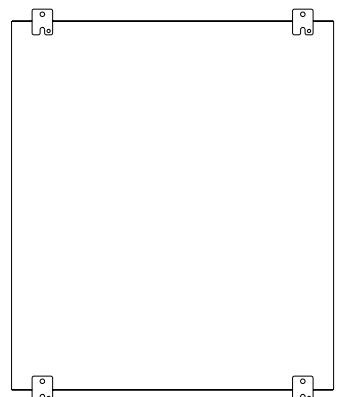

REAR VIEW

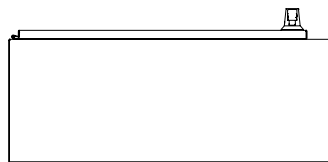

BOTTOM VIEW