

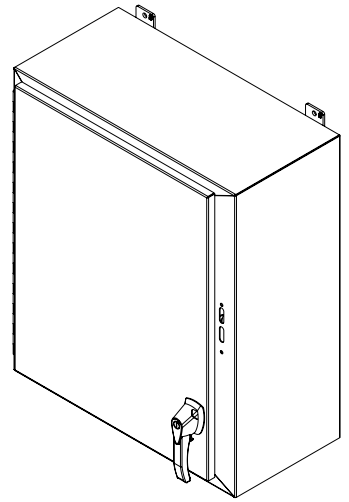

**PART No. 1447SE12HK**

for more information visit  
[www.hammondmfg.com](http://www.hammondmfg.com)

Data subject to change without  
notice\*  
\*M  
Isometric drawing Not to Scale



**ISOMETRIC VIEW**

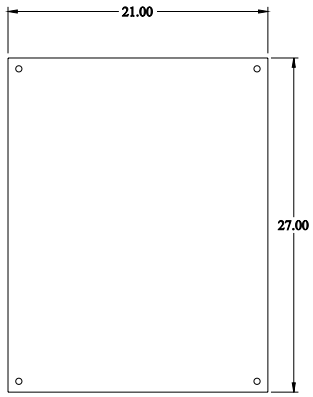

**INNER PANEL VIEW**

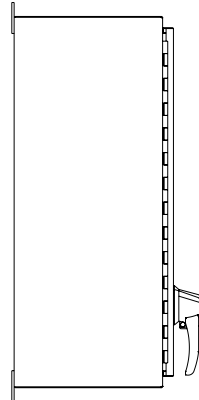

**LEFT SIDE VIEW**

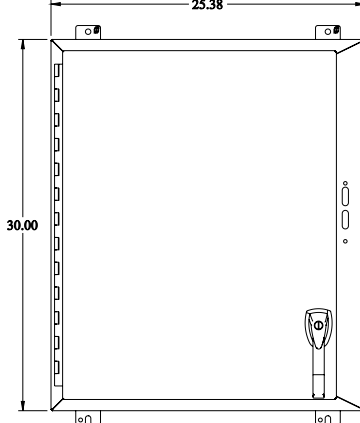

**FRONT VIEW**

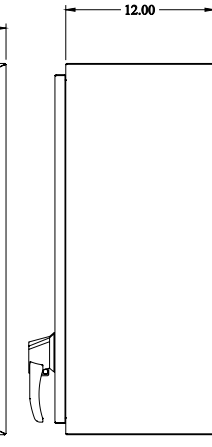

**RIGHT SIDE VIEW**

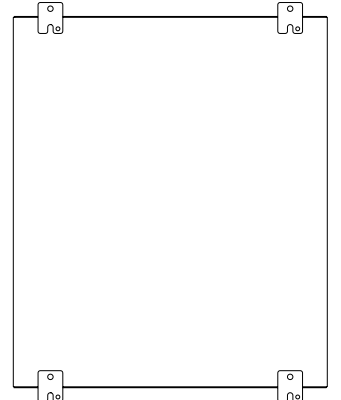

**REAR VIEW**

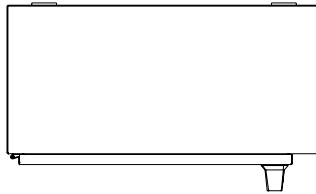

**TOP VIEW**

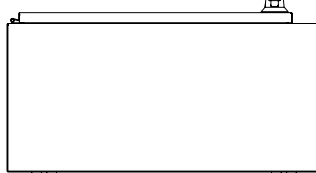

**BOTTOM VIEW**