

FITTING GUIDE

VW MK8 GOLF GTI : SIDE SPLITTER INSTRUCTIONS PAGE 2

INSTALLATION AND FITTING SERVICES

If you are having any difficulties please seek professional advice from the listed International and Domestic Authorised Dealers on our website.

www.flowdesignsaustralia.com

**SIDE SKIRT REMOVAL
REQUIRED**

REFERENCE DIAGRAMS

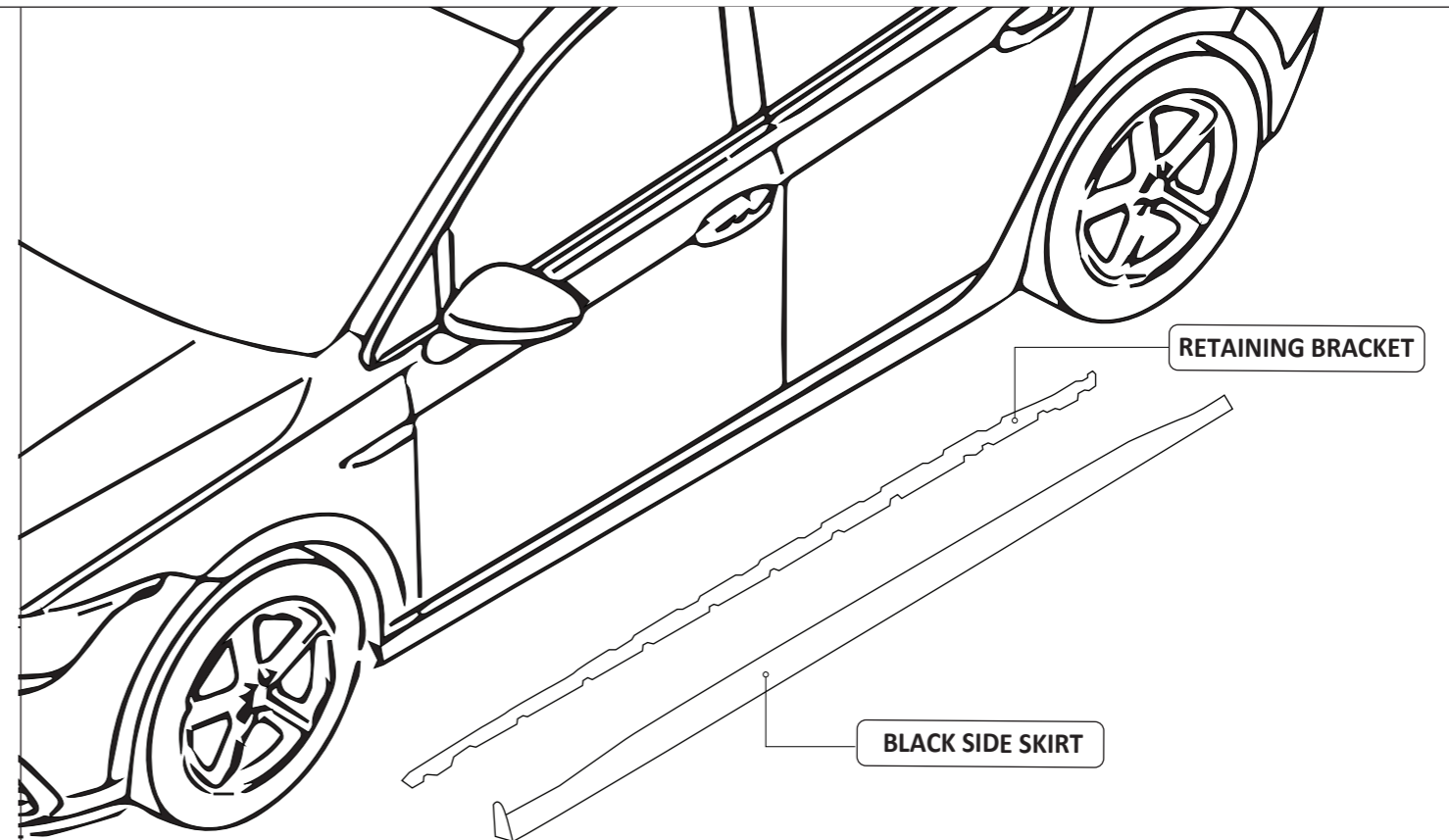
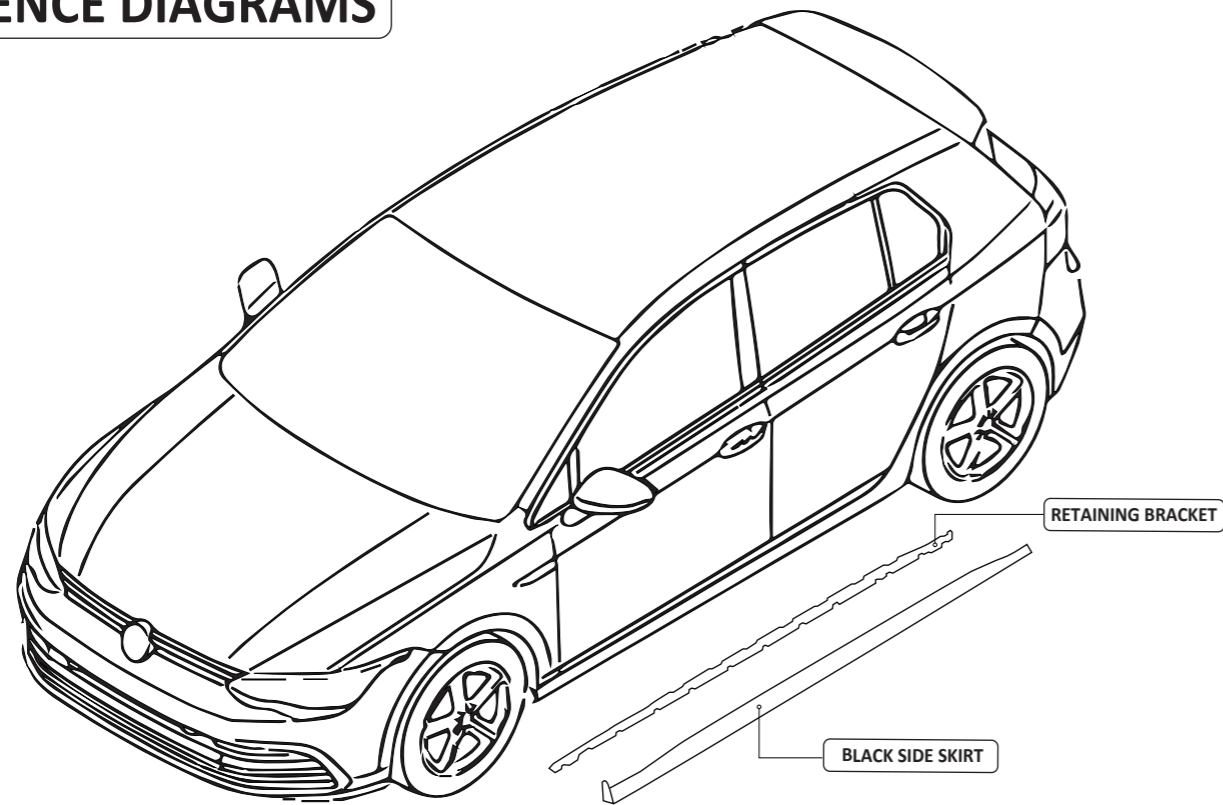

DISASSEMBLED STOCK MK8 GOLF GTI SIDE

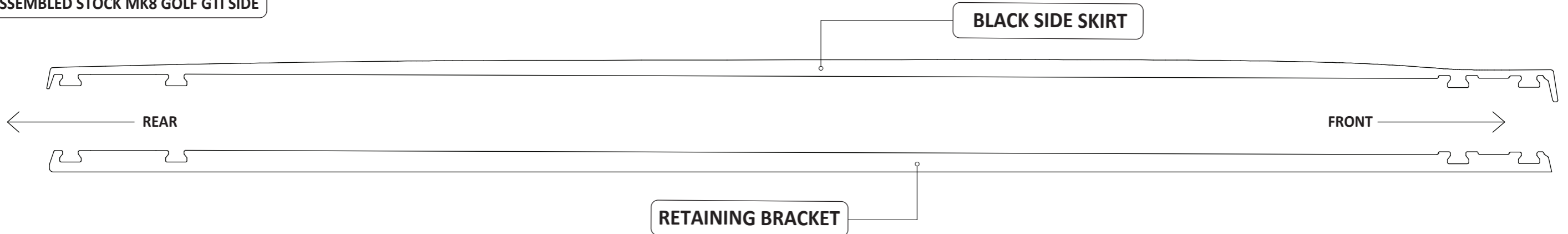

ASSEMBLED STOCK MK8 GOLF GTI SIDE

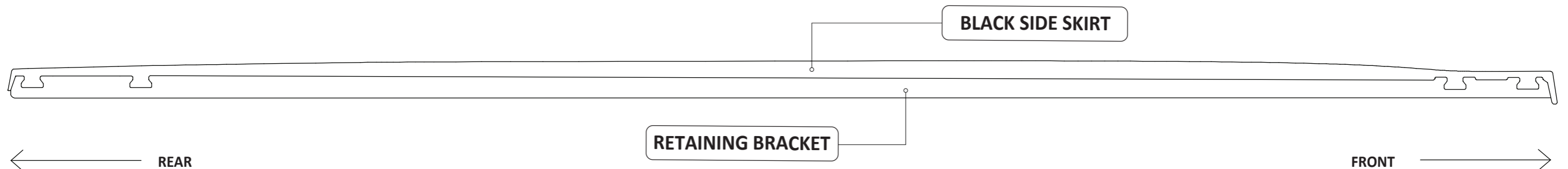

FITTING GUIDE

VW MK8 GOLF GTI : SIDE SPLITTER INSTRUCTIONS PAGE 3

INSTALLATION AND FITTING SERVICES

If you are having any difficulties please seek professional advice from the listed International and Domestic Authorised Dealers on our website.

www.flowdesignsaustralia.com

SIDE SKIRT REMOVAL REQUIRED

STEP 1

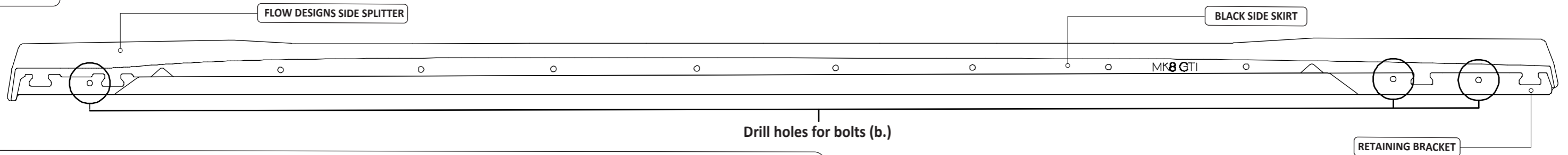

- Line up the back edge of the splitter ends to the back edge of the retaining bracket
- Using the splitter as a template, mark out and drill **7mm** holes for bolts (b.), ensuring to drill slowly to avoid hitting the metal sill
- Compress the supplied M5 rivnut into the previously drilled holes

STEP 2

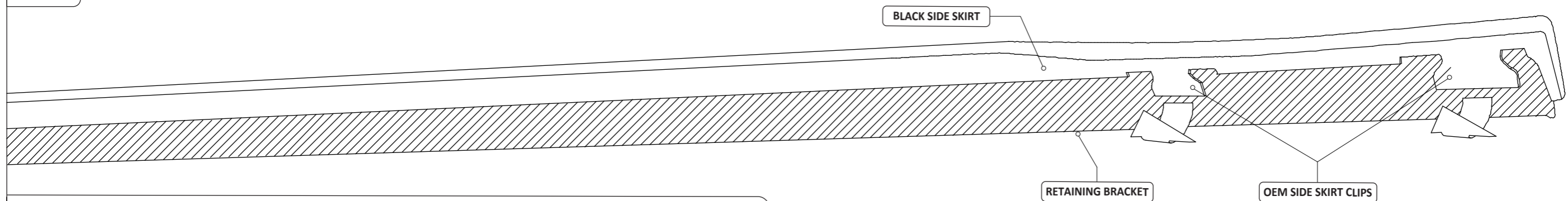

- Remove the OEM side skirt by unclipping the 4 side skirt clips and prying the the side skirt off from the bottom

STEP 3

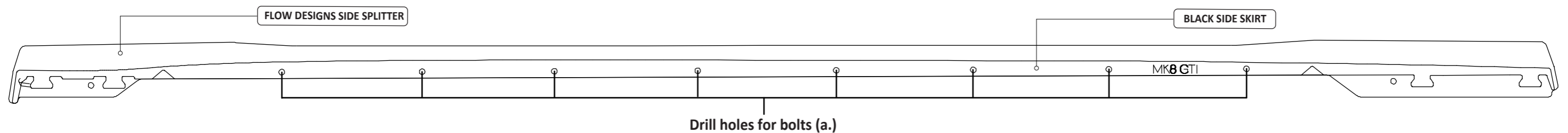

- Clamp the Flow Designs side splitter to the **OEM side skirt**, ensuring the back edges are flush to eachother
- Using the side splitter as a guide, mark out and drill holes for bolts (a.) using a 7mm drill bit
- Bolt the side splitter to the OEM side skirt using bolts (a.)

STEP 4

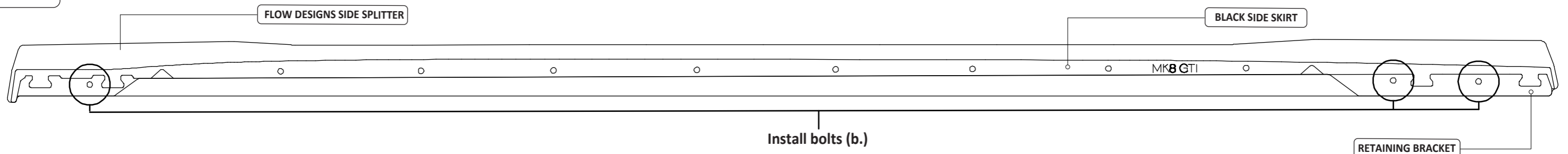

- Clip the OEM side skirt, with attached side splitter, back onto the retaining bracket, ensuring everything is clipped into place and that the side skirt is flush with the body of the car
- Install bolts (b.) into the previously installed rivnuts.

FITTING DIAGRAM

VW MK8 GOLF GTI : SIDE SPLITTER INSTRUCTIONS PAGE 1

INSTALLATION AND FITTING SERVICES

If you are having any difficulties please seek professional advice from the listed International and Domestic Authorised Dealers on our website.

www.flowdesignsaustralia.com

**SIDE SKIRT REMOVAL
REQUIRED**

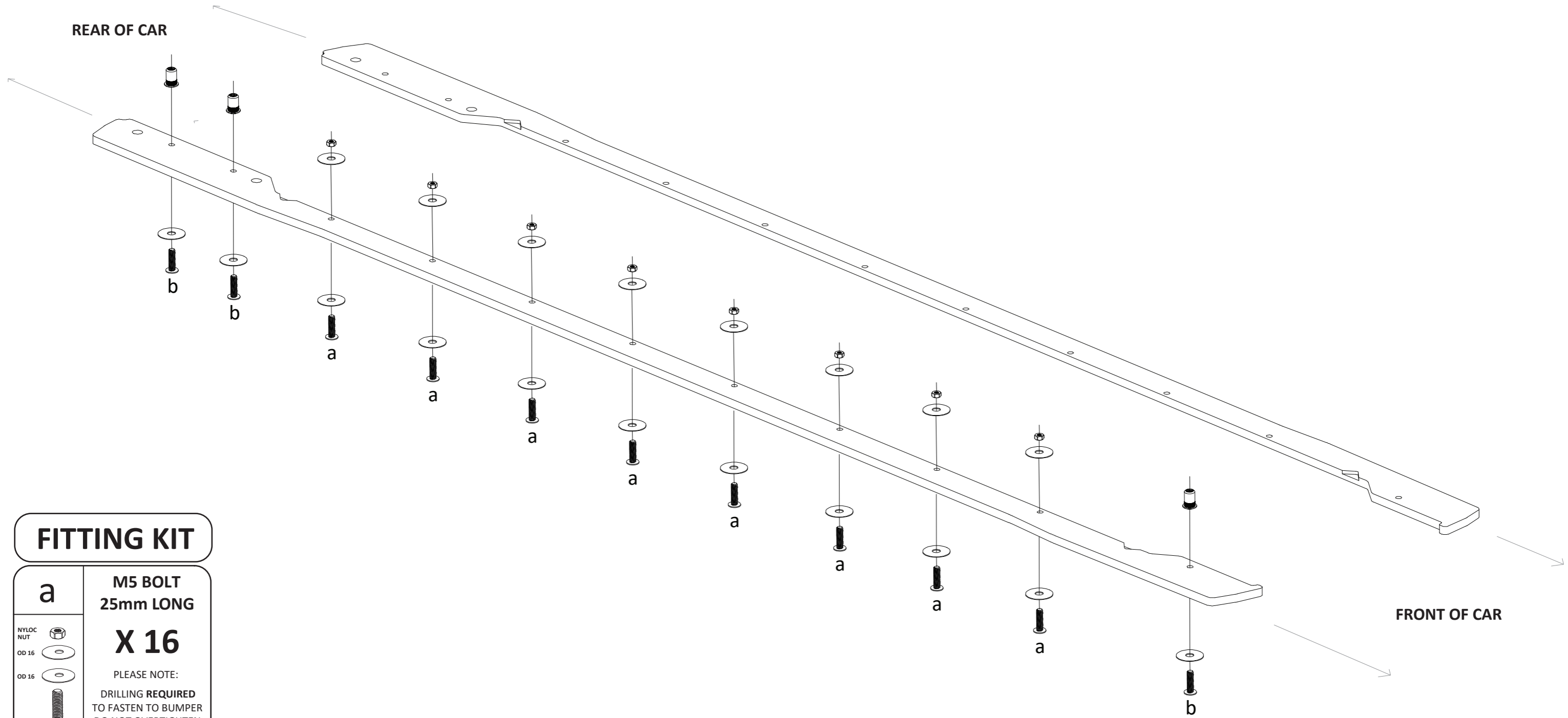

FITTING KIT

a

**M5 BOLT
25mm LONG**

X 16

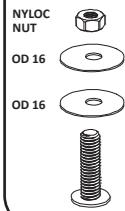

PLEASE NOTE:

DRILLING REQUIRED
TO FASTEN TO BUMPER
DO NOT OVERTIGHTEN

b

**M5 BOLT
25mm LONG**

X 6

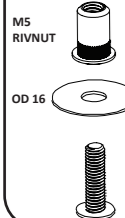

PLEASE NOTE:

DRILLING REQUIRED
USING A 7MM DRILL BIT

PLEASE NOTE
FOR ADD ON ACCESSORIES

DO NOT
OVERTIGHTEN FASTENERS
INTO BRASS FITTINGS

HAND TIGHTEN ONLY

FLOW
DESIGNS

FLOW DESIGNS
FLOW DESIGNS AUSTRALIA
ABN : 99 605 842 199
FACTORY 11
6-7 NICOLE CLOSE
BAYSWATER NORTH
VIC. 3153
DESIGNED AND MANUFACTURED IN AUSTRALIA

TERMS AND CONDITIONS : MISUSE OF GOODS

By taking possession of this Flow Designs Australia product, you (the buyer) agree that you have read, understood and will comply with the following disclaimer:

This product may not be suitable for road use in your area. We cannot be held liable for any penalties or infringements that may occur as a result of installing any of our products.

We cannot guarantee that this product will comply with subsequent market products you have applied to your vehicle. It is not legal to fit parts onto a road registered vehicle unless it carries and meets the design rules and public road regulations of your area, region and/or country.

We do make our best effort to consider safety when designing our products, we want the scene to be a safe place for everyone!

This disclaimer absolves us (Flow Designs Australia) of any and all liability for breaches to any requirement as a result of installation of our products.

www.flowdesignsaustralia.com