

# FITTING GUIDE

## VW AW POLO GTI - REAR SPOILER EXTENSION

### HANDY HINT

Spacer is separated into three parts. Install only middle spacer for drainage only option.

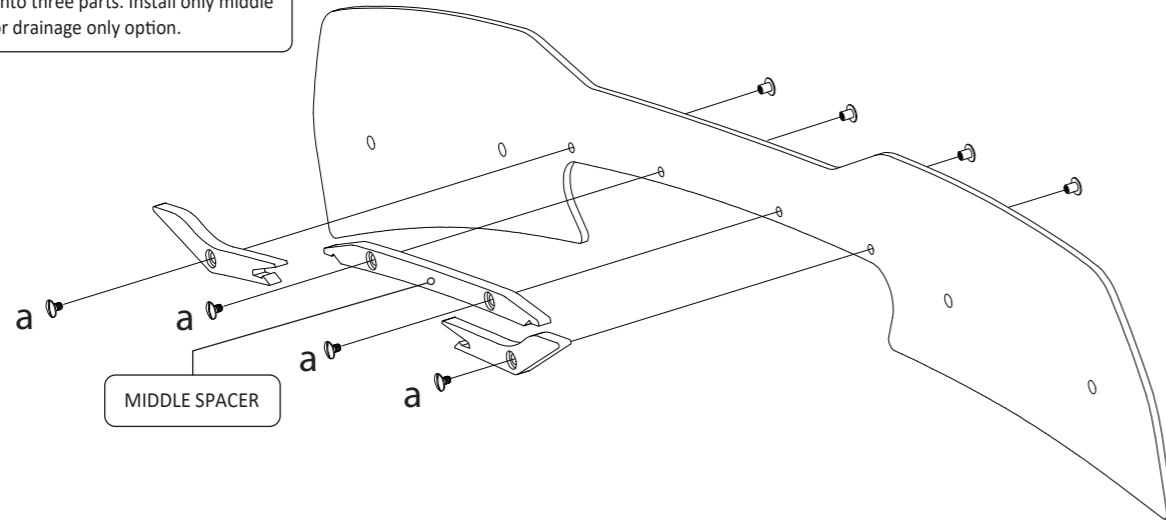

### STEP 1

- Choose between installing only the middle spacer for drainage, or the whole spacer set
- Using bolts (a.), install the spacer

### HANDY HINT

For better installation, cut tape to match the shape of the spacer

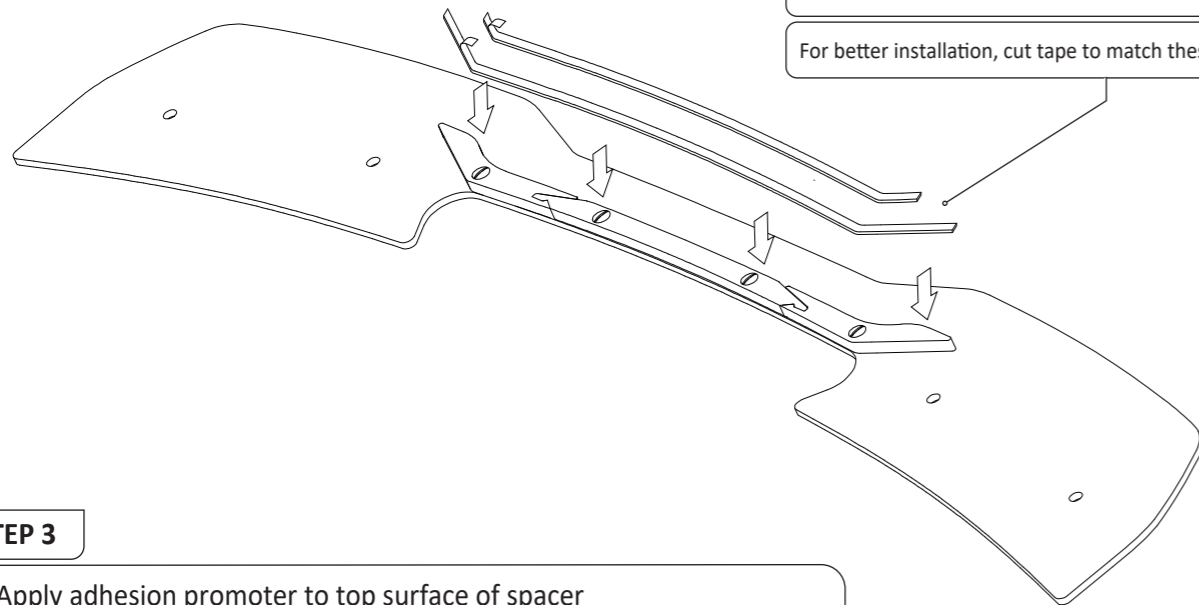

### STEP 3

- Apply adhesion promoter to top surface of spacer
- Apply two strips of 5mm wide black foam tape to top surface of spacer

### INSTALLATION AND FITTING SERVICES

If you are having any difficulties please seek professional advice from the listed International and Domestic Authorised Dealers on our website.

[www.flowdesignsaustralia.com](http://www.flowdesignsaustralia.com)

## OEM REAR SPOILER REMOVAL NOT REQUIRED

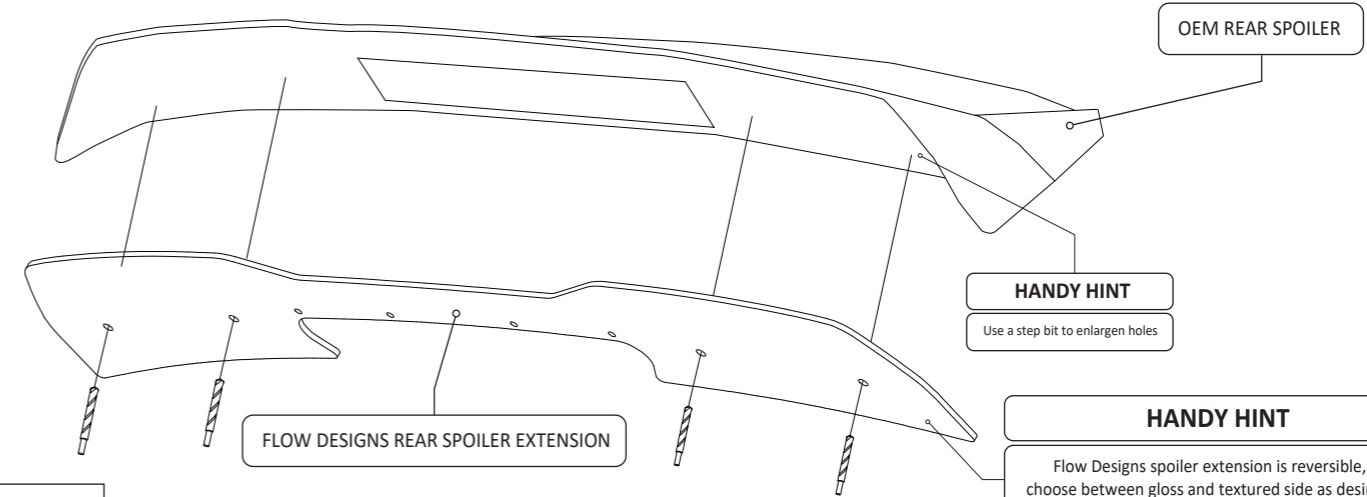



### STEP 2

- Choose between texture or gloss side face up
- Using a 6mm drill bit and the Flow Designs Rear Spoiler Extension as a guide, drill out pilot holes in OEM spoiler
- Remove Flow Designs Rear Spoiler Extension
- Enlarge pilot holes using a 10mm step bit

### STEP 4

- Install rubber nuts (b.) into previously drilled out holes

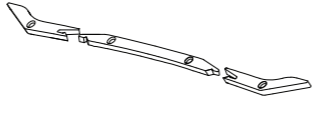
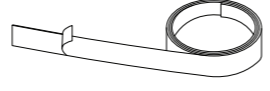
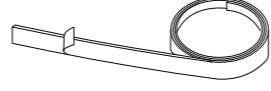
## FITTING KIT

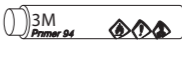
<p><b>a</b></p> <p><b>10mm LONG Chicago Screws</b></p> <p><b>X 4</b></p> <p>PLEASE NOTE: DRILLING NOT REQUIRED TO FASTEN TO OEM SPOILER DO NOT OVERTIGHTEN</p>	<p><b>b</b></p> <p><b>M5 Rubber Nuts</b></p> <p><b>X 4</b></p> <p>PLEASE NOTE: DRILLING REQUIRED TO FASTEN TO OEM SPOILER DO NOT OVERTIGHTEN</p>	<p><b>c</b></p> <p><b>M5 BOLT 25mm LONG</b></p> <p><b>X 4</b></p> <p>PLEASE NOTE: DRILLING REQUIRED TO FASTEN TO OEM SPOILER DO NOT OVERTIGHTEN</p>	<p><b>3D PRINTED SPACER</b></p> 	<p><b>3m of 12mm WIDE DOUBLE SIDED TAPE</b></p> 	<p><b>2m of 5mm WIDE BLACK FOAM DOUBLE SIDED TAPE</b></p> 	<p><b>ALCOHOL SWAB</b></p> 	<p><b>3M ADHESION PROMOTER</b></p> 	<p><b>FLOW DESIGNS</b></p> <p>FLOW DESIGNS AUSTRALIA ABN: 99 608 162 199 FACTORY 31 8/2 NICOLE CLOSE BAYSWATER NORTH VIC. 3153</p> <p>DESIGNED AND MANUFACTURED IN AUSTRALIA</p> <p><b>TERMS AND CONDITIONS : MISUSE OF GOODS</b></p> <p>This Product application is not intended for public road registered vehicles within Australia. Regulations may vary from Countries outside of Australia. Please check your Country's and State's road regulations before installing on a vehicle intended for public road use.</p> <p>Flow Designs Australia PTY LTD will not be liable for any liabilities in relation to any use of the goods other than in strict accordance with the Company's instructions and for the purpose and application for which the goods were supplied by the Company.</p> <p>The Client undertakes with the Company:</p> <ul style="list-style-type: none"> <li>• That it will acquaint itself with the requirements of all relevant government or statutory and other authorities, bodies or corporations relating to the goods and/or services and to the applications to which the goods and/or services are to be put;</li> <li>• That at all times while the goods are in its possession or under its control it will comply with such requirements;</li> <li>• That it will procure that any purchaser of goods from it will also acquaint itself with, and will comply with, such requirements;</li> <li>• That it will indemnify the Company against any liability resulting from a breach of any such requirements.</li> </ul> <p><a href="http://www.flowdesignsaustralia.com">www.flowdesignsaustralia.com</a></p>
--	--	---	--	---	---	--	--	--

# FITTING GUIDE

## VW AW POLO GTI - REAR SPOILER EXTENSION

### INSTALLATION AND FITTING SERVICES

If you are having any difficulties please seek professional advise from the listed International and Domestic Authorised Dealers on our website.

www.flowdesignsaustralia.com

## OEM REAR SPOILER REMOVAL NOT REQUIRED

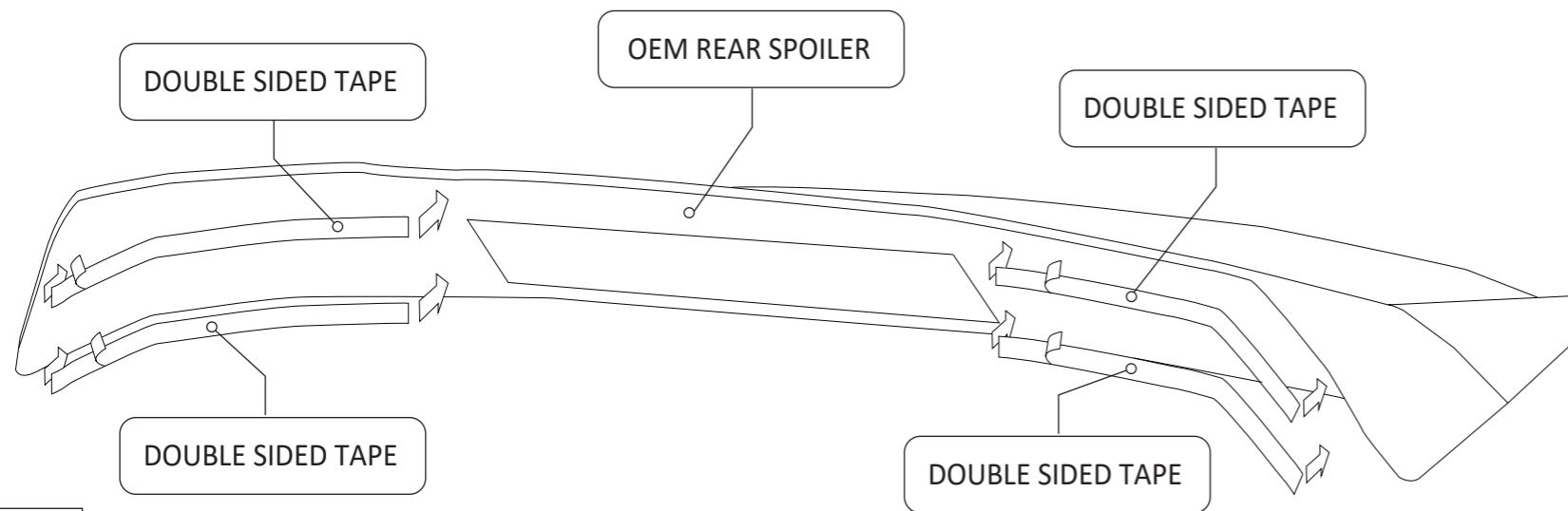

### STEP 5

- Using alcohol swab, clean surface of OEM Spoiler
- Apply double sided tape to OEM spoiler

## HANDY HINTS

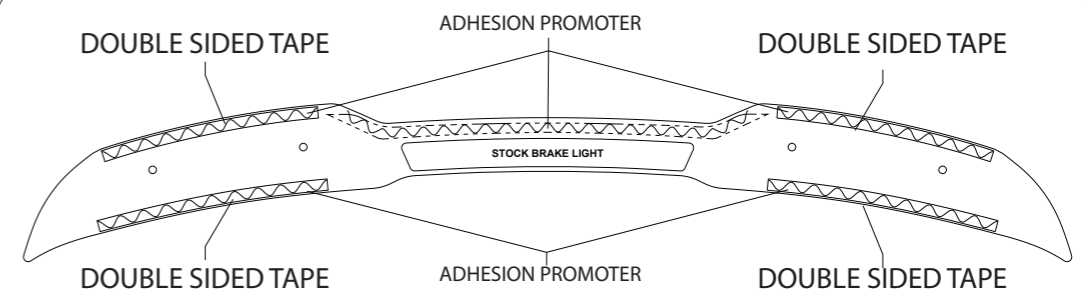

Use above diagram as a guide for where apply adhesion promoter and stick double sided tape on OEM rear spoiler

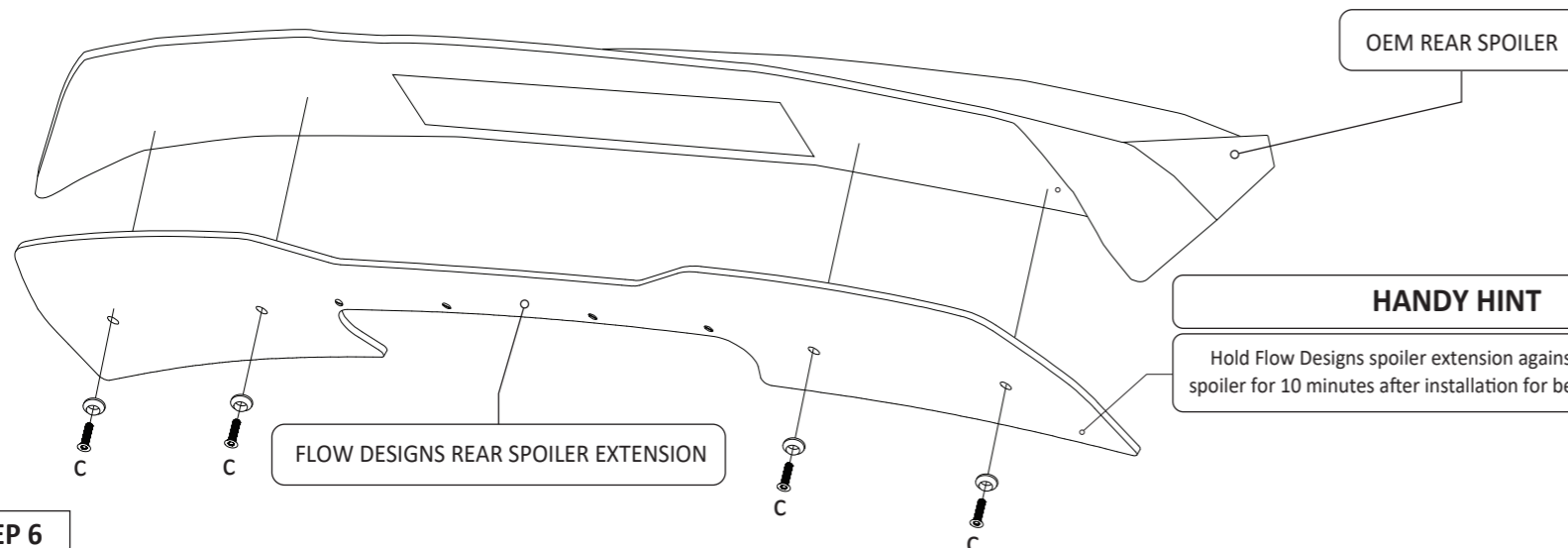

### STEP 6

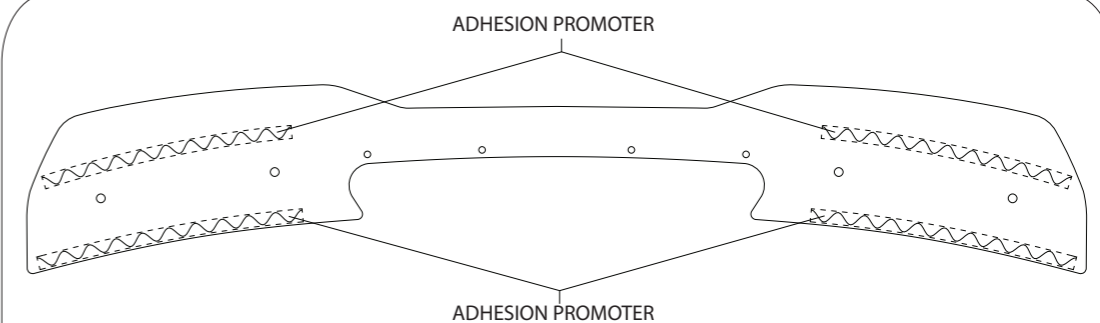

- Using alcohol swab, clean surface of Flow Designs spoiler extension
- Apply adhesion promoter to spoiler extension (see handy hint for applicaiton guide)
- Using bolts (c.), install Flow Designs spoiler extension to OEM rear spoiler

## HANDY HINTS

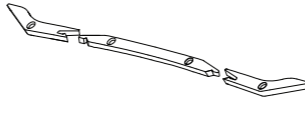
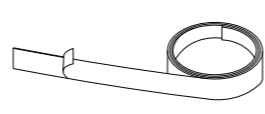
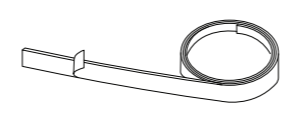

Use above diagram as a guide for where apply adhesion promoter to Flow Designs spoiler extension

## FITTING KIT

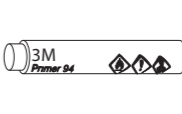
<p><b>a</b></p> <p><b>10mm LONG Chicago Screws</b></p> <p><b>X 4</b></p> <p>PLEASE NOTE: DRILLING NOT REQUIRED TO FASTEN TO OEM SPOILER DO NOT OVERTIGHTEN</p>	<p><b>b</b></p> <p><b>M5 Rubber Nuts</b></p> <p><b>X 4</b></p> <p>PLEASE NOTE: DRILLING REQUIRED TO FASTEN TO OEM SPOILER DO NOT OVERTIGHTEN</p>	<p><b>c</b></p> <p><b>M5 BOLT 25mm LONG</b></p> <p><b>X 4</b></p> <p>PLEASE NOTE: DRILLING REQUIRED TO FASTEN TO OEM SPOILER DO NOT OVERTIGHTEN</p>	<p><b>3D PRINTED SPACER</b></p> 	<p><b>3m of 12mm WIDE DOUBLE SIDED TAPE</b></p> 	<p><b>2m of 5mm WIDE BLACK FOAM DOUBLE SIDED TAPE</b></p> 	<p><b>ALCOHOL SWAB</b></p> 	<p><b>3M ADHESION PROMOTER</b></p> 	<p><b>FLOW DESIGNS</b></p> <p>FLOW DESIGNS AUSTRALIA ABN: 99 608 189 FACTORY 31 8/2 NICOLE CLOSE BAYSWATER NORTH VIC. 3153</p> <p>DESIGNED AND MANUFACTURED IN AUSTRALIA</p> <p><b>TERMS AND CONDITIONS : MISUSE OF GOODS</b></p> <p>This Product application is not intended for public road registered vehicles within Australia. Regulations may vary from Countries outside of Australia. Please check your Country's and State's road regulations before installing on a vehicle intended for public road use.</p> <p>Flow Designs Australia PTY LTD will not be liable for any liabilities in relation to any use of the goods other than in strict accordance with the Company's instructions and for the purpose and application for which the goods were supplied by the Company.</p> <p>The Client undertakes with the Company:</p> <ul style="list-style-type: none"> <li>• That it will acquant itself with the requirements of all relevant government or statutory and other authorities, bodies or corporations relating to the goods and/or services and to the applications to which the goods and/or services are to be put;</li> <li>• That at all times while the goods are in its possession or under its control it will comply with such requirements;</li> <li>• That it will procure that any purchaser of goods from it will also acquant itself with, and will comply with, such requirements;</li> <li>• That it will indemnify the Company against any liability resulting from a breach of any such requirements.</li> </ul> <p>www.flowdesignsaustralia.com</p>
--	--	---	--	---	---	--	--	--