

QUICKSTART GUIDE

WRX-900TOGO MODULAR LINE-ARRAY SPEAKER SYSTEM



SYSTEM SET-UP

Remove the System from its packaging

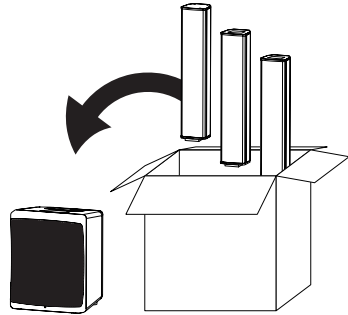

Spacers allow you to adjust the height of the Speaker Module

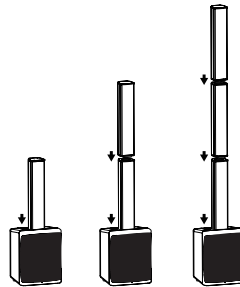

Connect the speaker to Mains power

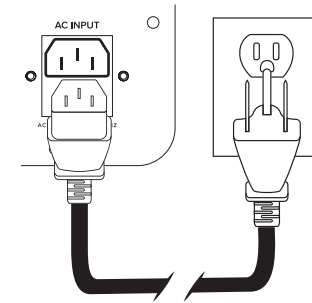

BLUETOOTH PAIRING

Press the BLUETOOTH Button on your WRX-900TOGO

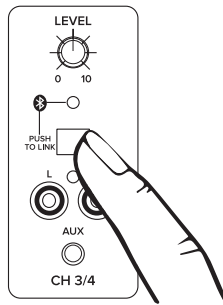

Turn BLUETOOTH on and Select WRX-900TOGO on your Mobile Device

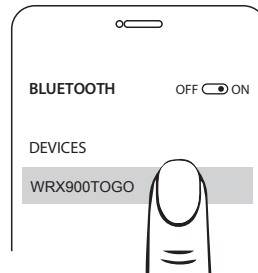

Play music from your Mobile Device

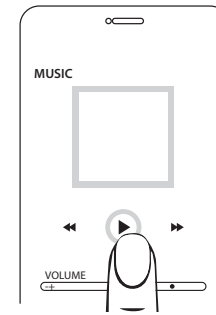

CONNECT MICROPHONE

Select Mic

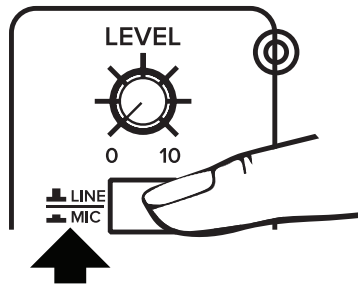

Connect your Microphone

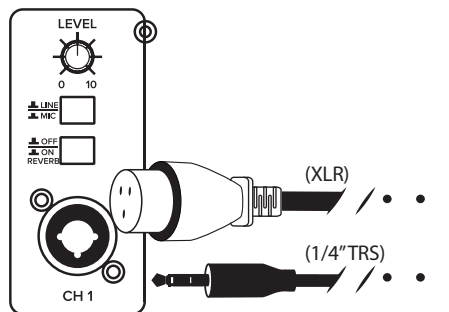

Turn Volume Knob to Adjust Mic Level

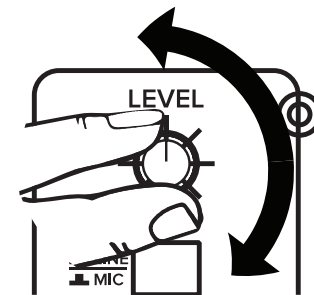

QUICKSTART GUIDE

WRX-900TOGO MODULAR LINE-ARRAY SPEAKER SYSTEM



CONNECT A LINE LEVEL SOURCE

Use Channel 3/4

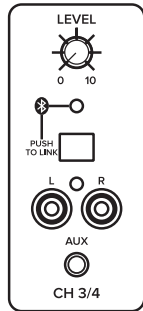

Connect your Device

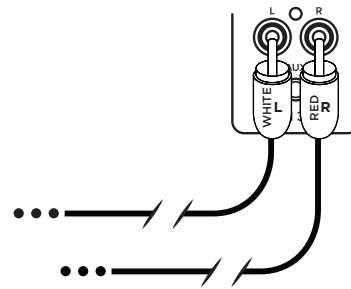

Turn Volume Knob to Adjust Line Level

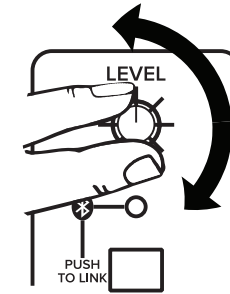

USING THE MASTER CONTROLS

Turn the Master knob to control overall Volume

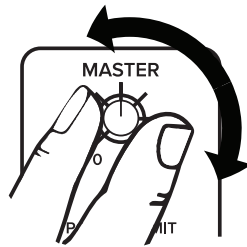

Use the Preset DSP to tailor the sound of your Speaker

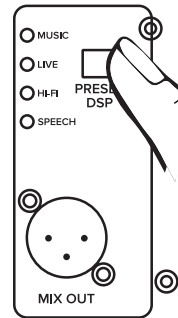

Use Reverb on your Mic to make your voice sound professional

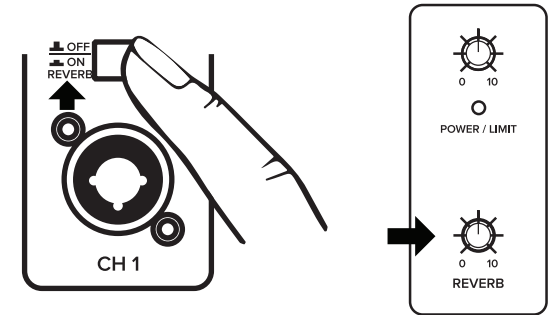

USING AN ADDITIONAL SPEAKER

(XLR cable required)

Plug one end into the Mix Out

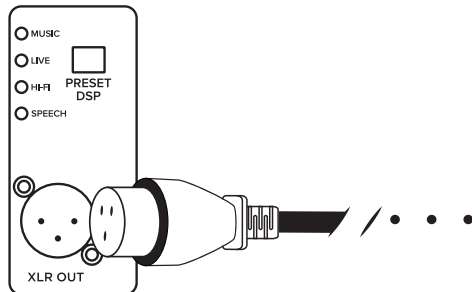

Plug the other end into a Line Input

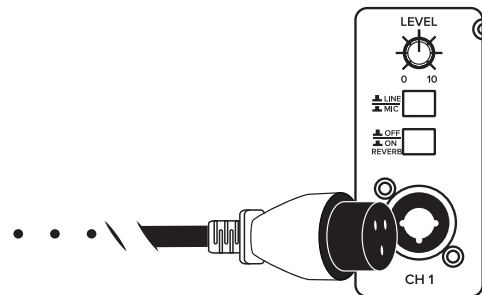

Separate the speakers to maximize coverage

