

# QUICKSTART GUIDE

## AS-TOGO SERIES PORTABLE RECHARGEABLE BLUETOOTH LOUDSPEAKERS



### CONNECT A MICROPHONE

Select Mic

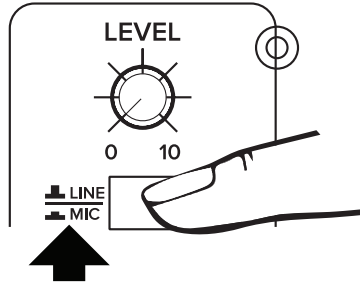

Connect your microphone

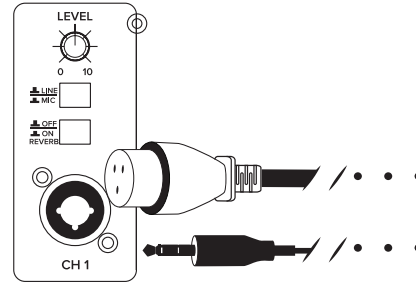

Turn volume knob to adjust mic level

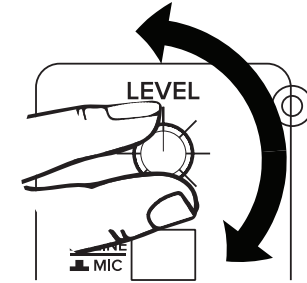

### CONNECT A LINE SOURCE

Locate the Line input (either RCA or 3.5mm TRS)

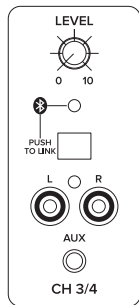

Connect your external source to speaker (RCA shown)

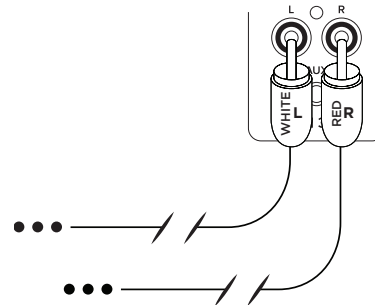

Turn volume knob to adjust input level

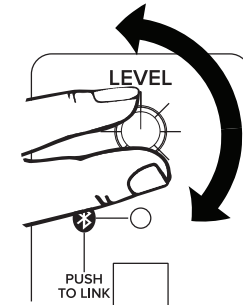

### CONNECT A BLUETOOTH DEVICE

Press MODE button until BT appears

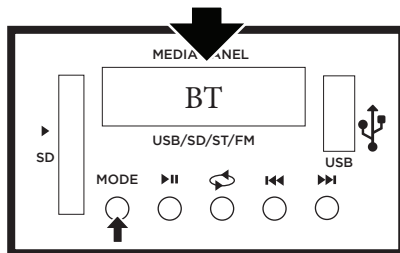

Turn BLUETOOTH on and select AS-TOGO speaker on your mobile device

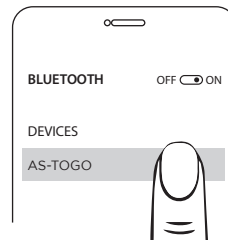

Play music from your mobile device

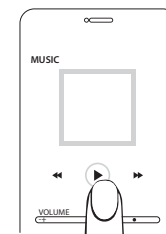

# QUICKSTART GUIDE

## AS-TOGO SERIES PORTABLE RECHARGEABLE BLUETOOTH LOUDSPEAKERS



### USING THE RADIO

Press MODE until FM appears

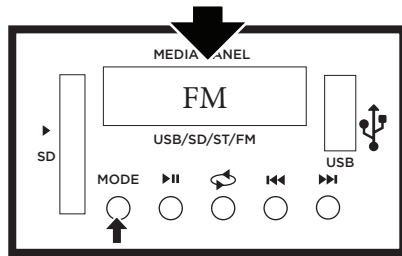

Press and hold the PLAY button to begin scanning for stations

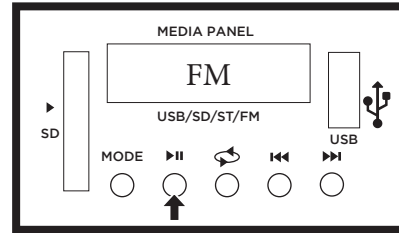

Use the I<< and >>I buttons to select from available presets

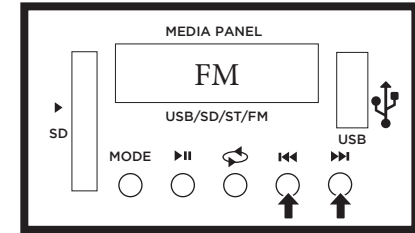

### CHARGING THE BATTERY

Connect the speaker to power to charge

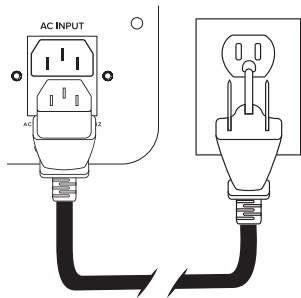

Charge the speaker when it reaches 25% remaining

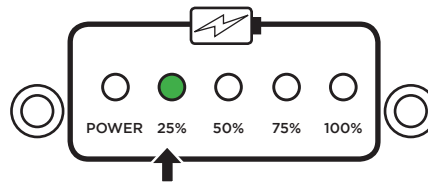

When charge reaches 100%, unplug the speaker from main power

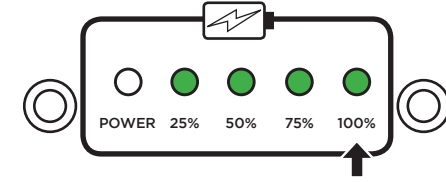

### USING THE RETRACTABLE HANDLE

To extend the handle, press the button in the middle of the handle and pull

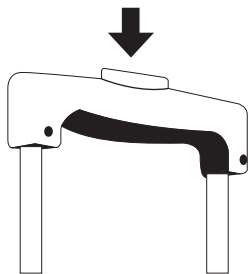

The handle will lock in 2 positions. Use the one most comfortable to you



To retract the handle, press the button and push the handle down until in the recessed position

