

peerless-AV<sup>®</sup>

SMARTMOUNT<sup>®</sup>  
Wall Mounts



# SMARTMOUNT®

## Wall Mounts

Recently redesigned with upgrades that benefit both the installer and end-user, SmartMount® wall mounts offer the most versatile installation features and mounting options. As a recognizable brand that customers know and love, we kept what was great and added various improvements, resulting in a seamless installation.



This series of mounts has passed the approval process for Underwriters Laboratories (UL), promoting safe living and working environments by the application of safety science and hazard-based safety engineering. SmartMount® mounts have been submitted to rigorous safety testing, including tests for strength and "pull out" to a minimum of four times the stated load capacity.

Peerless-AV®'s mounts are also RoHS compliant, which stands for the Restriction of Hazardous Substances. Through the restriction of six hazardous materials in electrical and electronic products, Peerless-AV® provides a safe environment for the consumer.



### Key Features and Benefits



Open Wall Plate

Allows for total wall access and increases electrical and cable management options

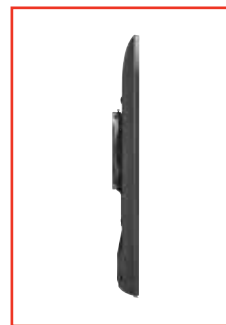

Low-Profile Design

Positions display close to the wall for a sleek mounting installation



Vertical Adjustment

Post-Installation Leveling across family of SmartMount® Flat, Tilt & Articulating Wall Mounts

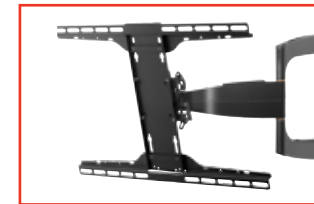

I-Shaped Adaptor Plate Design

Helps avoid blocking connections on back of display



Locking Tilt

Lock the display at any angle with the ratcheting handle



Integrated Cable Management

Protects, contains and conceals cables for a clean, professional installation

# SMARTMOUNT®

## Flat Wall Mounts

SmartMount® Flat Wall Mounts boast low-profile designs for a professional appearance. Medium to larger models now have horizontal and vertical adjustment features, allowing you to achieve perfect positioning of the display with post-installation leveling and side-to-side adjustability.

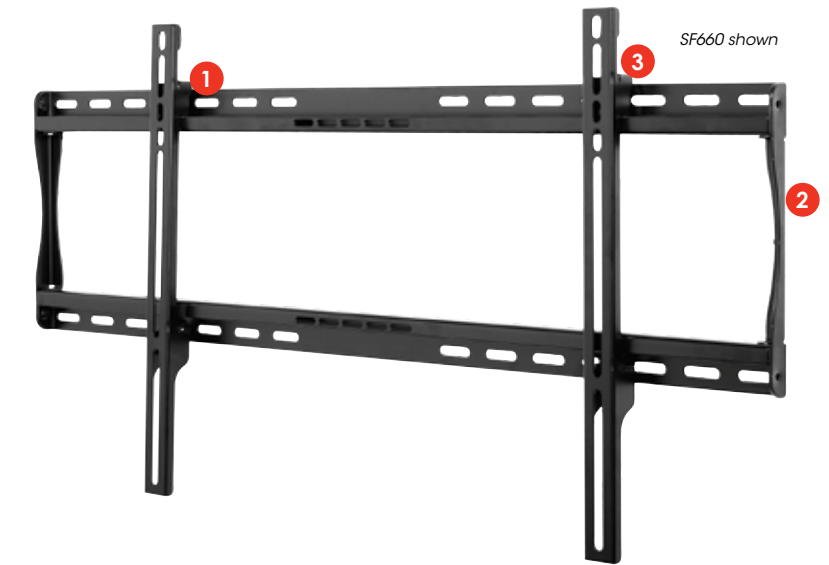

**1. HOOK-AND-HANG™ INSTALLATION**  
Display is easily installed by a single person

**2. LOW-PROFILE DESIGN**  
Creates an aesthetically appealing look

**3. HORIZONTAL & VERTICAL ADJUSTMENT**  
Post-installation leveling and side-to-side adjustability features allow fine tuning of the mounted display for the perfect positioning

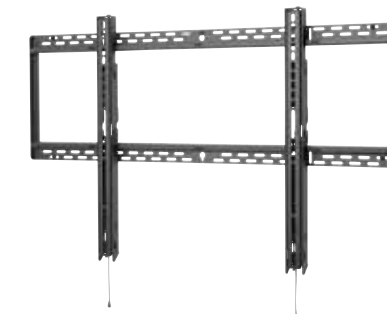

SF630(P)	SF632(P)	osbpd SF640(P)	osbpd SF650(P)	osbpd SF660(P)	SF670(P)	SF680(P)	SFP680
Display Size 10" to 29"	Display Size 22" to 40"	Display Size 32" to 50"	Display Size 39" to 75"	Display Size 39" to 80"	Display Size 46" to 90"	Display Size 60" to 98"	Display Size 46" to 90"
Max Load 80lb (36kg)	Max Load 115lb (52kg)	Max Load 150lb (68kg)	Max Load 175lb (79kg)	Max Load 200lb (91kg)	Max Load 250lb (113kg)	Max Load 350lb (158kg)	Max Load 350lb (158kg)
VESA® Pattern 75 and 100mm	VESA® Pattern 75, 100, 200 x 100 and 200 x 200mm	Mounting Pattern 450 x 405mm (17.72"W x 15.95"H)	Mounting Pattern 742 x 405mm (29.21"W x 15.95"H)	Mounting Pattern 824 x 405mm (32.44"W x 15.95"H)	Mounting Pattern 895 x 450mm (35.25"W x 17.72"H)	Mounting Pattern 1100 x 650mm (43.29"W x 25.59"H)	Mounting Pattern 494 x 650mm (19.45"W x 25.59"H)
Distance From Wall 0.96" (24mm)	Distance From Wall 1.02" (26mm)	Distance From Wall 1.20" (30mm)	Distance From Wall 1.20" (30mm)	Distance From Wall 1.20" (30mm)	Distance From Wall 1.73" (44mm)	Distance From Wall 1.73" (44mm)	Distance From Wall 1.70" (43mm)
Metal Stud Accessory ACC215	Metal Stud Accessory ACC215	Metal Stud Accessory ACC415	Metal Stud Accessory ACC415	Metal Stud Accessory ACC415	Metal Stud Accessory ACC615	Metal Stud Accessory ACC615	Metal Stud Accessory ACC615

- Display adaptor simply slides into the wall plate for quick and easy installation

- Low-profile design positions display close to the wall

- Offers up to 0.25" (6mm) of vertical adjustment on each universal display adaptor bracket for post-installation leveling and height adjustment fine-tuning

- Offers horizontal adjustment for centering display on wall

- Lateral display adjustment and 1" of post-installation vertical adjustment

- Adaptor rail latching feature securely locks the display in place with an audible click

- Designed for mounting a display in portrait orientation

# SMARTMOUNT®

## Tilt Wall Mounts

SmartMount® Tilt Wall Mounts offer tilt adjustment without the use of tools. Various tilt mechanisms, including One-Touch™ and Increlok™, allow just the right range of adjustment to ensure a proper viewing angle. The Tilt Wall Mounts also offer both horizontal and vertical adjustment.

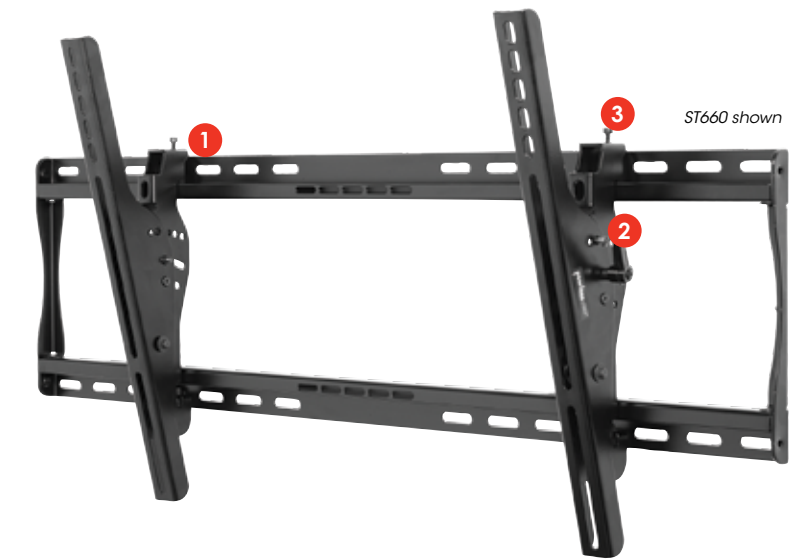

**1. HOOK-AND-HANG™ INSTALLATION**  
Display is easily installed by a single person

**2. INCRELOK™ TILT TECHNOLOGY**  
Lock the tilt angle for the perfect view and prevent tampering or undesired adjustment

**3. HORIZONTAL & VERTICAL ADJUSTMENT**  
Post-installation leveling and side-to-side adjustability features allow fine tuning of the mounted display for the perfect positioning

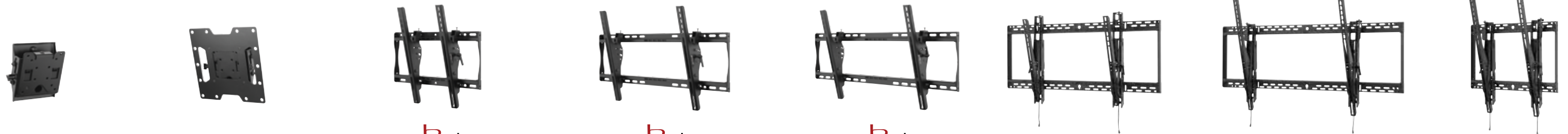

ST630(P)	ST632(P)	ST640(P)	ST650(P)	ST660(P)	ST670(P)	ST680(P)	STP680
Display Size 10" to 29"	Display Size 22" to 40"	Display Size 32" to 50"	Display Size 39" to 75"	Display Size 39" to 80"	Display Size 46" to 90"	Display Size 60" to 98"	Display Size 46" to 90"
Max Load 80lb (36kg)	Max Load 115lb (52kg)	Max Load 150lb (68kg)	Max Load 175lb (79kg)	Max Load 200lb (91kg)	Max Load 250lb (113kg)	Max Load 350lb (158kg)	Max Load 350lb (158kg)
VESA® Pattern 75 and 100mm	VESA® Pattern 75, 100, 200 x 100 and 200 x 200mm	Mounting Pattern 458 x 405mm (18.02"W x 15.95"H)	Mounting Pattern 742 x 405mm (29.21"W x 15.95"H)	Mounting Pattern 824 x 405mm (32.44"W x 15.95"H)	VESA® Pattern 895 x 450mm (35.25"W x 17.72"H)	Mounting Pattern 1061 x 650mm (41.76"W x 25.59"H)	Mounting Pattern 455 x 650mm (17.91"W x 25.59"H)
Distance From Wall 1.58"-2.23" (40-57mm)	Distance From Wall 1.65"-2.82" (42-72mm)	Distance From Wall 2.62"-5.40" (67-137mm)	Distance From Wall 2.62"-5.40" (67-137mm)	Distance From Wall 2.62"-5.40" (67-137mm)	Distance From Wall 3.00"-6.63" (76-168mm)	Distance From Wall 3.38"-10.58" (86-269mm)	Distance From Wall 3.38"-10.58" (86-269mm)
Tilt +15°/-5°	Tilt +15°/-5°	Tilt +15°/-5°	Tilt +15°/-5°	Tilt +15°/-5°	Tilt +15°/-5°	Tilt +15°/-5°	Tilt +15°/-5°
Metal Stud Accessory ACC215	Metal Stud Accessory ACC215	Metal Stud Accessory ACC415	Metal Stud Accessory ACC415	Metal Stud Accessory ACC415	Metal Stud Accessory ACC615	Metal Stud Accessory ACC615	Metal Stud Accessory ACC615

- Display adaptor simply slides into the wall plate for quick and easy installation

- Easy-Grip™ ratcheting handle locks tilt angle into place

- Offer up to 0.25" (6mm) of vertical adjustment on each universal display adaptor bracket for post-installation leveling and height adjustment fine-tuning

- Included IncreLok™ feature offers fixed tilt lock in 5° increments when used

- Adjustable up to 15° of forward tilt and -5° of backward tilt with optional IncreLok™ feature

- Adaptor rail latching feature securely locks the display in place with an audible click

- Lateral display adjustment and 1" of post-installation vertical adjustment

- Designed for mounting a display in portrait orientation

# SMARTMOUNT®

## Pivot & Pull-Out Pivot Wall Mounts

With SmartMount® Pivot and Pull-out Pivot Wall Mounts, displays can be extended, turned, and tilted to achieve the perfect viewing angle. The pull-out functionality is ideal for in-wall or recessed applications.

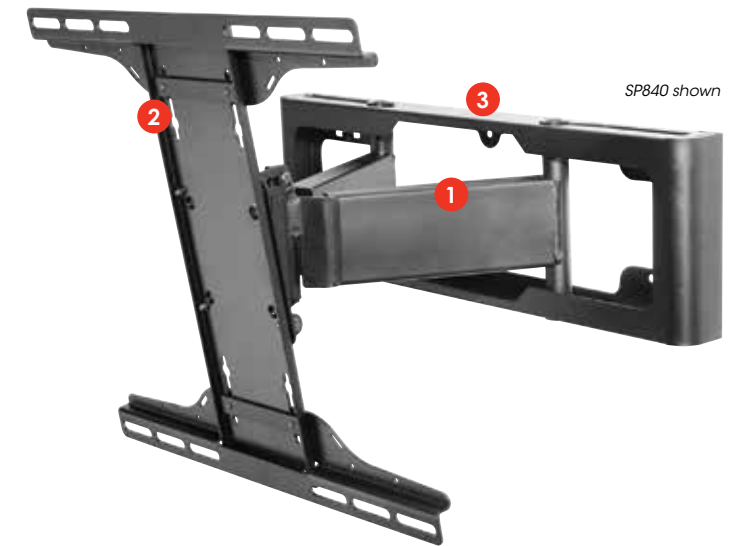

### 1. PULL-OUT SERVICE ACCESS

Provides easy access to the back of the display for maintenance

### 2. I-SHAPED ADAPTOR PLATE

Helps avoid blocking connections on back of display

### 3. AUTO CENTERING

Extended or retracted, the display remains centered on the mount

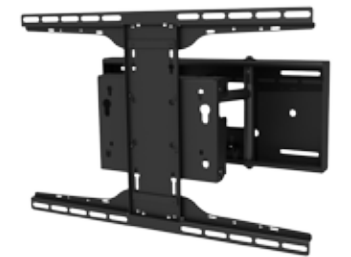
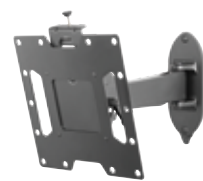

osdp

SP730P	SP740P	SP746PU
<b>Display Size</b> 10" to 29"	<b>Display Size</b> 22" to 40"	<b>Display Size</b> 32" to 50"
<b>Max Load</b> 25lb (11kg)	<b>Max Load</b> 80lb (36kg)	<b>Max Load</b> 80lb (36kg)
<b>VESA® Pattern</b> 75 and 100mm	<b>VESA® Pattern</b> 100 x 100, 200 x 100 and 200 x 200mm	<b>Mounting Pattern</b> up to 400 x 400mm (15.75"W x 15.75"H)
<b>Distance From Wall</b> 2.77"-9.88" (70-251mm)	<b>Distance From Wall</b> 3.03"-12.41" (77-315mm)	<b>Distance From Wall</b> 3.46"-12.84" (88-326mm)
<b>Tilt   Swivel   Roll</b> ±35°   ±90°   ±5°	<b>Tilt   Pivot   Roll</b> +15°/-5°   ±90°   ±5°	<b>Tilt   Pivot   Roll</b> +15°/-5°   ±90°   ±5°
<b>Metal Stud Accessory</b> WSP700/WSP701	<b>Metal Stud Accessory</b> WSP700/WSP701	<b>Metal Stud Accessory</b> WSP700/WSP701

SP840	SP850(P)	SP850-UNL(P)
<b>Display Size</b> 32" to 55"	<b>Display Size</b> 32" to 80"	<b>Display Size</b> 32" to 80"
<b>Max Load</b> 60lb (27kg)	<b>Max Load</b> 150lb (68kg)	<b>Max Load</b> 150lb (68kg)
<b>Mounting Pattern</b> 400 x 400mm (15.75"W x 15.75"H)	<b>VESA® Pattern</b> 100 x 100 and 200 x 100mm	<b>Mounting Pattern</b> 600 x 400mm (23.62"W x 15.75"H)
<b>Distance From Wall</b> 2.51"-11.43" (64-290mm)	<b>Distance From Wall</b> 2.31"-10.68" (59-271mm)	<b>Distance From Wall</b> 2.73"-11.18" (69-284mm)
<b>Tilt   Pivot   Roll</b> 0°, 3.3°, 6.6° or 10°   ±30°   ±1°	<b>Tilt   Pivot   Roll</b> 0°, 5° or 10°   ±45°   ±1°	<b>Tilt   Pivot   Roll</b> 0°, 5° or 10°   ±45°   ±1°
<b>Metal Stud Accessory</b> ACC415	<b>Metal Stud Accessory</b> WSP816/820/824	<b>Metal Stud Accessory</b> -

- ±90° of pivot allows for perfect display positioning
- One-Touch™ tilt offers ±35° of viewing angle adjustment

- ±90° of pivot allows for perfect display positioning
- One-Touch™ tilt mechanism allows adjustment of +15/-5° without the use of tools

- ±0.5" (13mm) of vertical adjustment for post-installation height adjustment fine-tuning

- Adjustable latching mechanism controls the tension required to close mount against wall

- Easy pull-out pivot provides quick maintenance access

- Ideal in applications where display needs to be recessed into wall

# SMARTMOUNT®

## Articulating Wall Mounts

Fully-equipped with exceptional functionality and a stylish appearance, the SmartMount® Articulating Wall Mounts have been perfectly redesigned. Full-motion capabilities allow you to pivot, tilt, extend or retract the display for the ideal viewing angle.



SA761PU shown

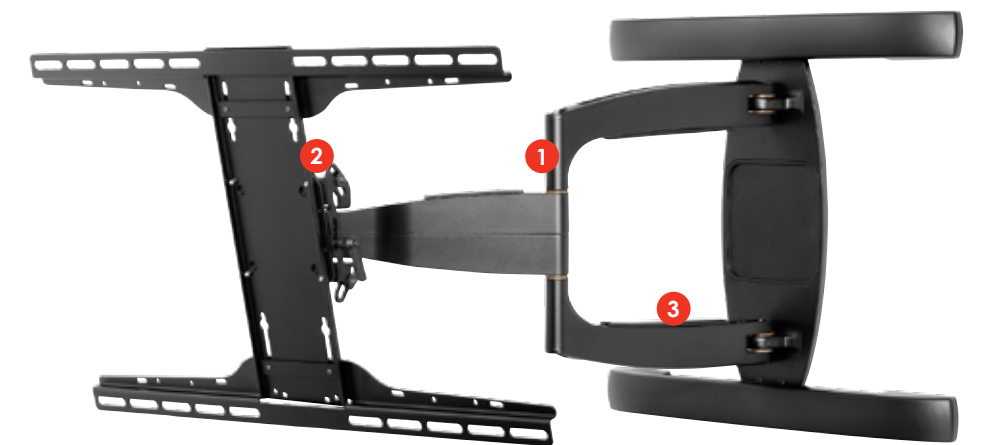

**1. EXTENDS UP TO 26.60" (676mm)**  
Offers the perfect viewing angle

**2. POST-INSTALLATION HEIGHT ADJUSTMENT**  
±0.5" (13mm) of vertical adjustment fine-tunes positioning of display after installation

**3. INTEGRATED CABLE MANAGEMENT**  
Protects, contains and conceals cables for a clean, professional installation

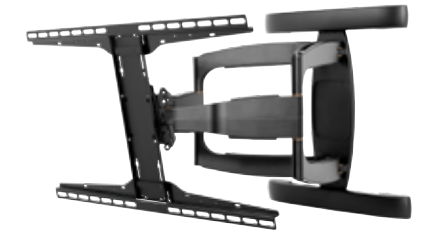
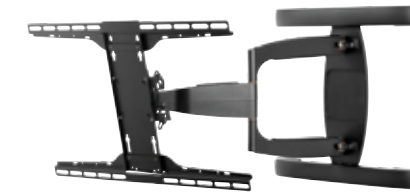
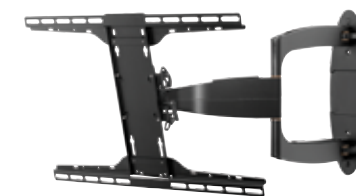

os**h**pd

os**h**pd

os**h**pd

os**h**pd

os**h**pd

os**h**pd

SA730P

SA740P

SA746PU

SA752PU

SA761PU

SA771PU

Display Size  
10" to 29"

Display Size  
22" to 40"

Display Size  
32" to 50"

Display Size  
37" to 55"

Display Size  
39" to 75"

Display Size  
46" to 90"

Max Load  
25lb (11kg)

Max Load  
80lb (36kg)

Max Load  
80lb (36kg)

Max Load  
90lb (42kg)

Max Load  
125lb (57kg)

Max Load  
150lb (68kg)

VESA® Pattern  
75 and 100mm

VESA® Pattern  
100 x 100, 200 x 100 and 200 x 200mm

Mounting Pattern  
up to 400 x 400mm  
15.75"W x 15.75"H

Mounting Pattern  
600 x 400mm  
(23.62"W x 15.75"H)

Mounting Pattern  
600 x 400mm  
(23.62"W x 15.75"H)

Mounting Pattern  
800 x 400mm  
(31.50"W x 15.75"H)

Distance From Wall  
2.77"-16.99" (70-432mm)

Distance From Wall  
3.03"-21.80" (77-554mm)

Distance From Wall  
3.46"-22.22" (88-564mm)

Distance From Wall  
2.97"-26.47" (75-672mm)

Distance From Wall  
3.10"-26.60" (79-676mm)

Distance From Wall  
3.10"-26.60" (79-676mm)

Tilt | Pivot | Roll  
±35° | ±90° | ±5°

Tilt | Pivot | Roll  
+15°/-5° | ±90° | ±5°

Tilt | Pivot | Roll  
+15°/-5° | ±90° | ±5°

Tilt | Pivot | Roll  
+15°/-5° | ±90° | ±5°

Tilt | Pivot | Roll  
+15°/-5° | ±90° | ±5°

Tilt | Pivot | Roll  
+15°/-5° | ±90° | ±5°

Metal Stud Accessory  
WSP700/WSP701

Metal Stud Accessory  
WSP700/WSP701

Metal Stud Accessory  
WSP700/WSP701

Metal Stud Accessory  
WSP756

Metal Stud Accessory  
WSP756

Metal Stud Accessory  
WSP756

- ±90° of pivot allows for perfect display positioning
- One-Touch™ tilt offers ±35° of viewing angle adjustment

- ±90° of pivot allows for perfect display positioning
- One-Touch™ tilt mechanism allows adjustment of +15°/-5° without the use of tools

- ±0.5" (13mm) of vertical adjustment for post-installation height adjustment fine-tuning



- Integrated Cable Management protects, contains, and conceals cables for a clean, professional installation

- Landscape or portrait mounting options increases display versatility

- The I-Shaped Adaptor plate's innovative design helps avoid blocking connections on back of display



For over 75 years, passion and innovation continues to drive Peerless-AV® forward. We proudly design and manufacture the highest quality products, ranging from outdoor displays to complete kiosk solutions, digital signage mounts to wireless systems. Whether a full-scale global deployment or custom project, Peerless-AV develops meaningful relationships and delivers world class service. In partnership with Peerless-AV, you are trusting an award-winning team of experts who will support your business every step of the way.

 [peerless-av.com](http://peerless-av.com)  
 800-865-2112