

User Manual and Installation Guide



RAD-0502

CO2 Controller for Grow Rooms



CO2METER
GAS MEASUREMENT SPECIALISTS

CO2Meter

**105 Runway Drive Ormond Beach, FL 32174 USA
(877) 678-4259**

Copyright © CO2Meter, Inc. All Rights Reserved.

Revision 00.00

Contents:

Introduction to the RAD-0502 CO2 Controller for Grow Rooms.....	4
Key Features.....	4
Package Content.....	5
Device Layout.....	6
Indoor CO2 Grow Controller (Main Unit)	6
Indoor CO2 Grow Controller (Sensor Unit).....	7
Connection Diagram	7
Icons and Symbols	8
Specifications.....	10
Dimensional Drawings	11
Safety Precautions	12
Installation	13
Operation	14
Startup Detection	14
Switch Unit1 and Unit2.....	14
Display Content Scrolling (Main Reading Displayed).....	14
Display Content Scrolling (Sub Readings Displayed).....	15
Change Table Time Range.....	15
Warning Message.....	15
Access Menu	16
Menu Options.....	16
Access Help Menu.....	16
Relay Function Selection	17
Relay & Display Access and Selection.....	17
CO2 Setting Options.....	18
CO2 Calibration.....	19
Temp Setting Options.....	20
RH Setting Option	20
Light Setting Options	21
Time Settings	22
Display and Backlight Sleep Settings	22
Buzzer Settings.....	24
Recovery Setting (Factory Reset)	24

Clear Calibration Values	25
Maintenance.....	26
Warranty	26
Product Returns.....	27
Support	27
Contact Us	27

Introduction to the RAD-0502 CO2 Controller for Grow Rooms

Thank you for selecting the RAD-0502 CO2 Controller for Grow Rooms, which is designed to regulate CO2 levels and allows growers to set high/low targets to maximize plant yields and profitability. The CO2 Controller for Grow Rooms uses a dual beam NDIR technology to accurately measure CO2 concentrations up to 3,000ppm. With a built-in temperature measurement and photo sensor, the controller can turn off relays during dark periods to save Carbon Dioxide (during greenhouse mode). Furthermore, the CO2 grow controller is an ideal solution for many growers who utilize the device across indoor greenhouses, cultivation centers, hydroponic rooms, or anywhere regulated CO2 levels are important for plant growth.

Key Features

- Accurate CO2 control for small to large sized indoor grow facilities
- Control 2 zones with 2 sensors
- Customizable CO2 set points for high and low target levels
- Dual beam NDIR technology accurately measures CO2 concentrations 0-3,000ppm
- Built-in temperature, humidity, and light
- Relay output can automatically control CO2 generator or compressed CO2 tanks
- Versatile modes for greenhouse or HVAC

Package Content

The RAD-0502 package comprises the following parts:

- (1) Indoor CO2 Controller
- (2) Remote CO2 Sensors
- (2) Relay Cables
- (2) CAT5e Cables - 25' ft.
- (1) Wall Plug Safety Strap
- (1) Mounting Bracket
- (6 pieces) Screws
- (1) Power Supply
- (3 pieces) International Power Adapters



Device Layout

Indoor CO2 Grow Controller (Main Unit)

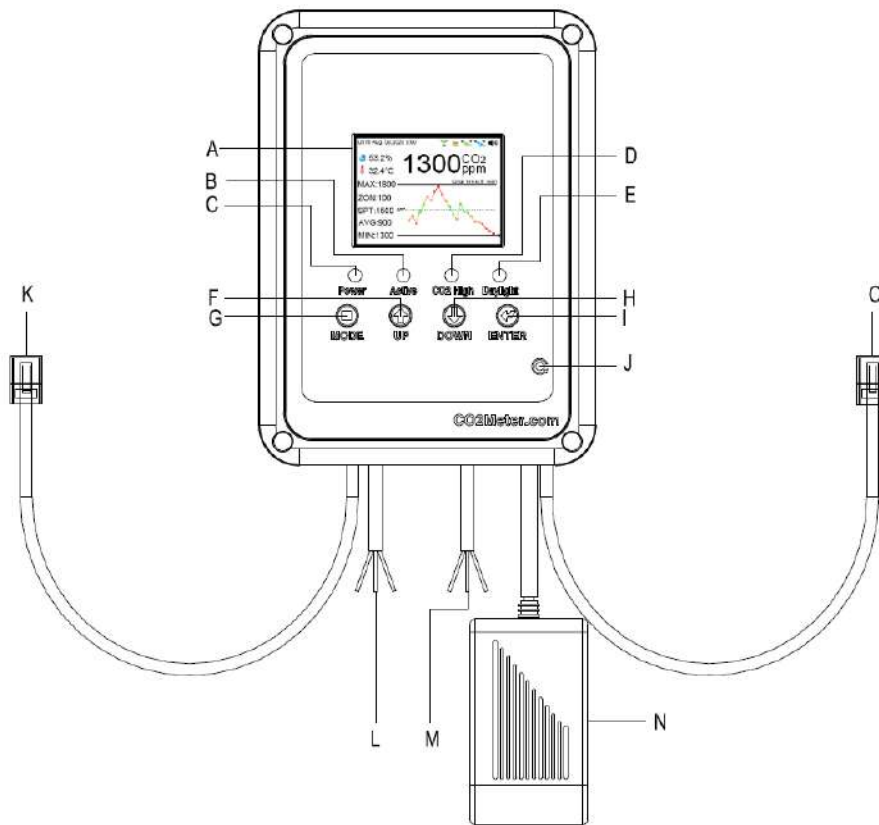

A. LCD Display

B. Green LED
(Indicates active relay)

C. Green LED
(Indicated power)

D. Green LED
(Indicates CO2 concentration rises above Set point)

E. Green LED
(Indicated presence of light: Daytime Mode)

F. UP Button

G. MODE Button

H. DOWN Button

I. ENTER Button

J. RESET Button

K. Communication Cable to Sensor Unit 1(Main Unit)

L. TEMP/RH/LIGHT Relay Cable

M. CO2 Relay Cable

N. Power plug

O. Communication Cable to Sensor Unit 2

Indoor CO2 Grow Controller (Sensor Unit)

- A. CO2 Entry
- B. LCD Display
- C. Panel Holder
- D. Green LED (lights when relay activate)
- E. Green LED (lights when daytime)
- F. TEMP&HR Sensor
- G. Photo Sensor (monitor light or darkness)
- H. Communication Cable to Main Unit

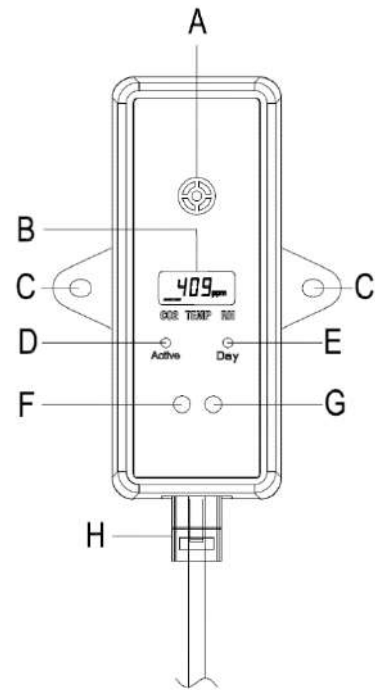



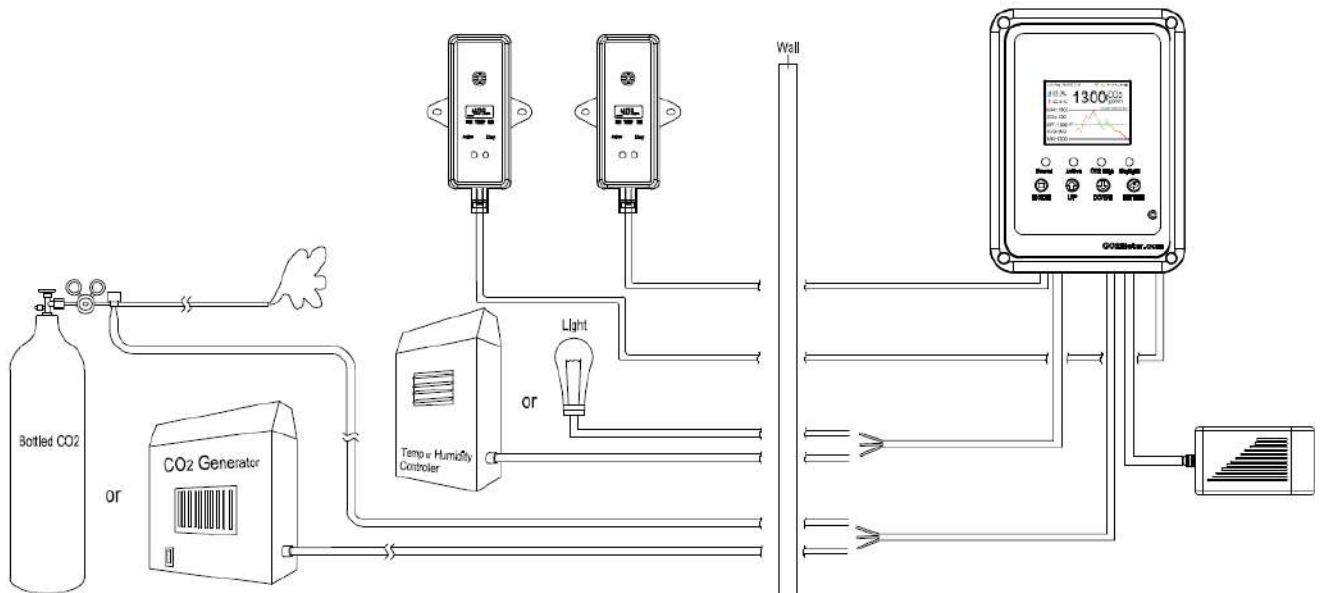







Connection Diagram



Icons and Symbols

Symbol	Meaning	Description
1300 ^{CO2} _{ppm}	CO2 Reading	CO2 Concentration in ppm (Parts Per Million)
50 ^{RH} _%	Humidity Reading	Displays current Humidity Switched by pressing "MODE" key
24 ^{TEMP} _{°C}	Temperature Reading	Displays current temperature. Switched by pressing "MODE" key.
0.2 ^{LIGHT} _{lx}	Light Reading	Displays light reading. Switched by pressing "MODE" key.
MAX:	Maximum	Displays the maximum value in the selected time
MIN:	Minimum	Displays the minimum value in the selected time
AVG:	Average	Displays the average value in the selected time
SPT:	Set point	Displays the user set point
ZON:	Zone	Displays the user set zone
INT:	Interval	Display the time interval represented by each column of the table
EXP:	Expect	Displays the duration of the desired light intensity in the selected time range
SPT-----	Set point indicator lines	Displays the set point line on the chart
SPT>MAX SPT<MIN	Set point out of table range	Indicator lines do not appear in the chart, when set point is out of range

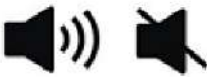
:	Value of each line	Display the value of each row in the table
	Three states of temperature	Show the temperature state
	Three states of Humidity	Show the humidity state
	Two states of light	Show the light states (Daytime / Nighttime)
	Two states of CO2 in HVAC mode	Show the CO2 states in HVAC mode (Mushroom Mode)
	Two states of CO2 in greenhouse mode	Show the CO2 states in Green House mode (Grow House Mode)
	Two states of CO2 relay	Show the CO2 relay states
	Two states of TEMP relay	Show the TEMP relay states
	Two states of RH relay	Show the RH relay states
	Two states of Light relay	Show the RH relay states
	Atmospheric pressure	Display the current atmospheric pressure value
	Two states of buzzer	Indicates the state of the buzzer

Specifications

Device Specification	
Measurement Range	0 - 3,000ppm
Display Resolution	1ppm at 0~1,000ppm; 10ppm above 1,000ppm
Accuracy	0~2,000ppm: ± 70 ppm or $\pm 5\%$ of reading whichever is greater; >2000ppm: $\pm 7\%$ of reading
Pressure Dependence	0.13% of reading per mm Hg
Repeatability	± 20 ppm @400ppm
Response Time	<2 minutes for 63% response to step change
Warm-Up Time	<60 seconds at 71.6°F (22°C)
Ingress Protection Rating	IP54
Power Input	9~32VDC (12~24VDC recommended), 2A. (Adaptor Included)
Backup Battery	6VDC (5.4V~7.0V), recommended capacity is 12AH
Relay 1	Dry contact relay controlled by AL1 (2Amp) (NO or NC)
Relay 2	Dry contact relay controlled by AL2 (2Amp) (NO or NC)
Temperature/Humidity/Light Specification:	
Temp Range	32°F to 122°F (0°C to 50°C)
Temp Accuracy	$\pm 2.7^\circ\text{F}$ ($\pm 1.5^\circ\text{C}$)
Temp Display Resolution	0.1°F (0.1°C)
Temp Display Options	°C/°F
Temp Response Time	20-30 minutes (Enclosure must equalize with environment)
RH Range	0 ~ 95% RH non-condensing
RH Accuracy	$\pm 5\%$
Light Range	0 ~ 60000Lx
Light Accuracy	± 50 Lx or 5% of reading whichever is greater
Operating Conditions:	
Temperature	32°F to 122°F (0°C to 50°C)
Humidity Range	0 ~ 95% RH non-condensing
Storage Conditions:	
Storage Temperature	-4°F to 140°F (-20°C to 60 °C)

Dimensional Drawings

(Dimensions are in inches)

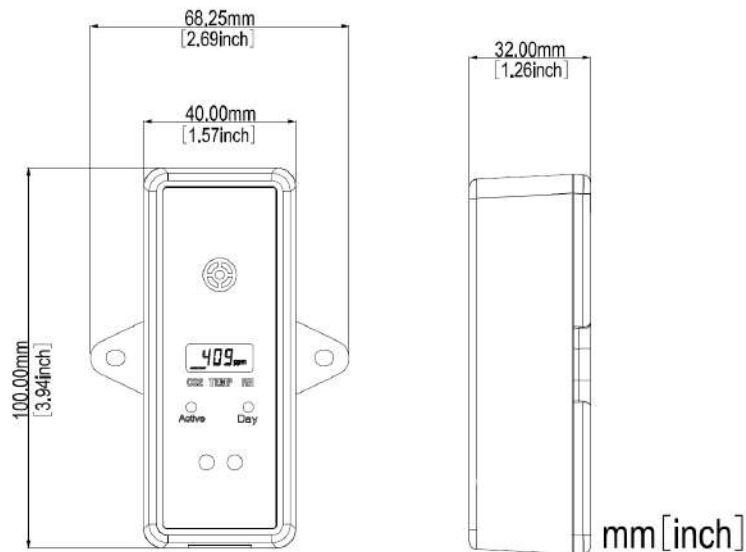
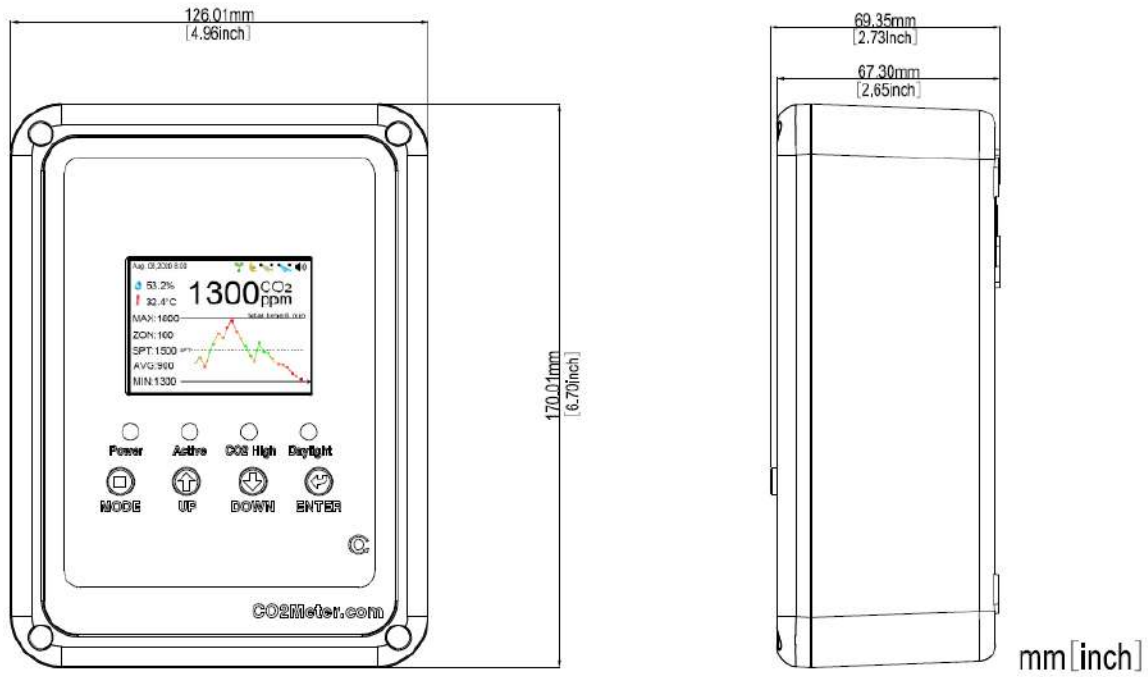

Safety Precautions

At CO2Meter, your safety is very important to us. To ensure correct and safe use of the RAD-0502 controller for grow rooms, please read this entire user manual before operation.

Otherwise, the protection provided by the equipment manufacturer may be impaired. Please adhere to the warnings below that highlight important safety information and should always be observed.

- Please handle the device carefully, do NOT subject the unit to impact or shock, otherwise this may decrease the sensor's overall accuracy and precision.
- Do NOT place the unit or the power plug near a heat source, as heat can distort the unit and may result in fire or injury.
- Do NOT open the CO2 Grow Controller or touch any of the exposed electronic circuitry, under any circumstances. Should you touch any exposed wiring, this can result in electric shock.
- Only connect devices to the RAD-0502 CO2 Grow Controller that use grounded plugs.
- Our replacement sensor can NOT be used to monitor additional grow spaces, this device can ONLY monitor CO2 concentrations in up to (2) grow zones.
- **Please Note: the RAD-0502 may NOT be used for CO2 safety per OSHA guidelines as it does not meet the need to measure and operate at OSHA's Short Term Exposure Limit of 30,000 ppm.**

Installation

1. Choose a suitable location at plant level to install the CO2 Sensor unit.
2. Choose a suitable location at eye level to mount the CO2 Grow Controller unit.
3. Next, connect a CO2 generator or bottled CO2 control regulator to the desired relays (please note the CO2 Grow Controller has 2 relay outputs. The relays can control a CO2 generator or a bottled CO2 regulator to produce CO2).
4. The first relay will then be triggered, and the power will be supplied when the CO2 concentration is out of the desired set point range.
5. The second relay will then be triggered allowing temperature, humidity, and light capabilities dependent upon the user preference.

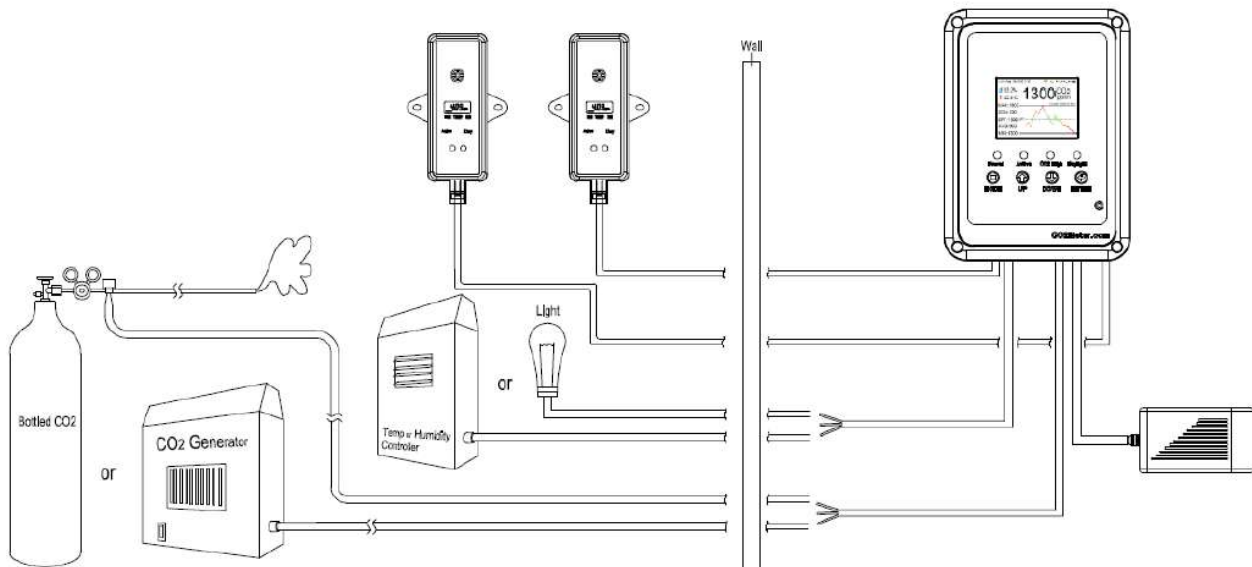

Operation

Startup Detection

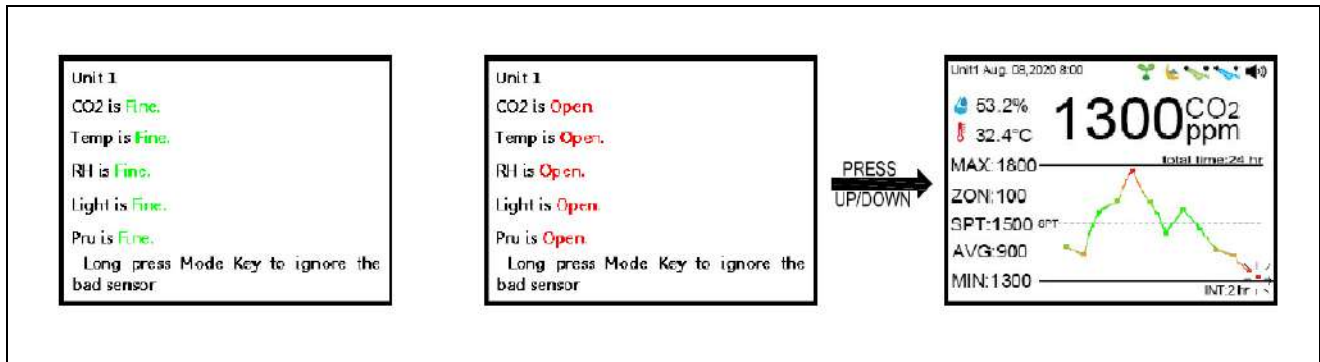

1. Start up to read the status of sensor unit, the green font of sensor displays "fine" normally, and the red font displays "open" abnormally

If you want to manually ignore the wrong sensor, long press the mode key for 3 seconds to exit the prompt interface and enter the main screen

Switch Unit1 and Unit2

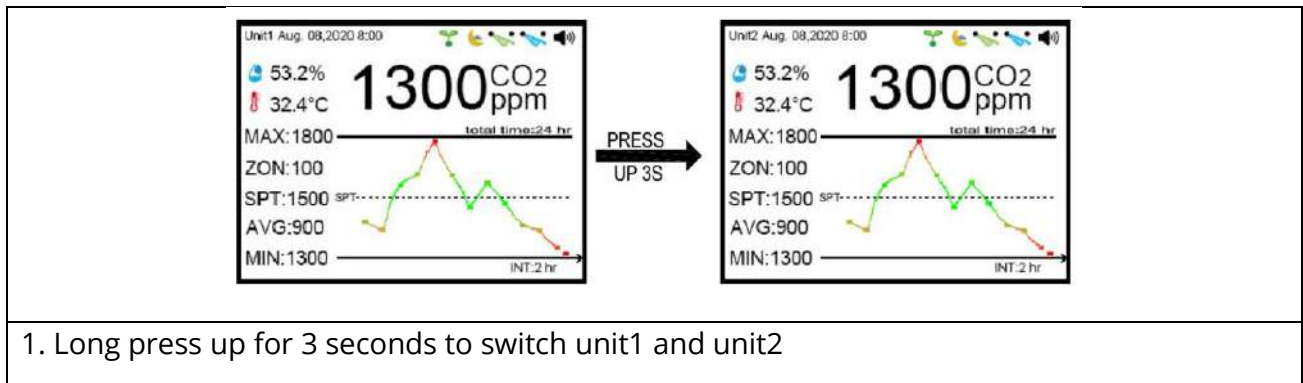

1. Long press up for 3 seconds to switch unit1 and unit2

Display Content Scrolling (Main Reading Displayed)

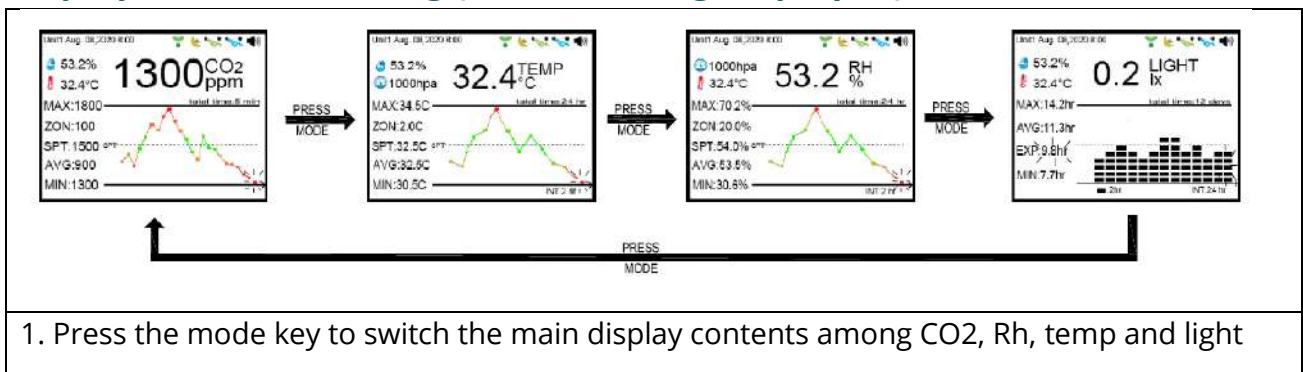

1. Press the mode key to switch the main display contents among CO2, Rh, temp and light

Display Content Scrolling (Sub Readings Displayed)

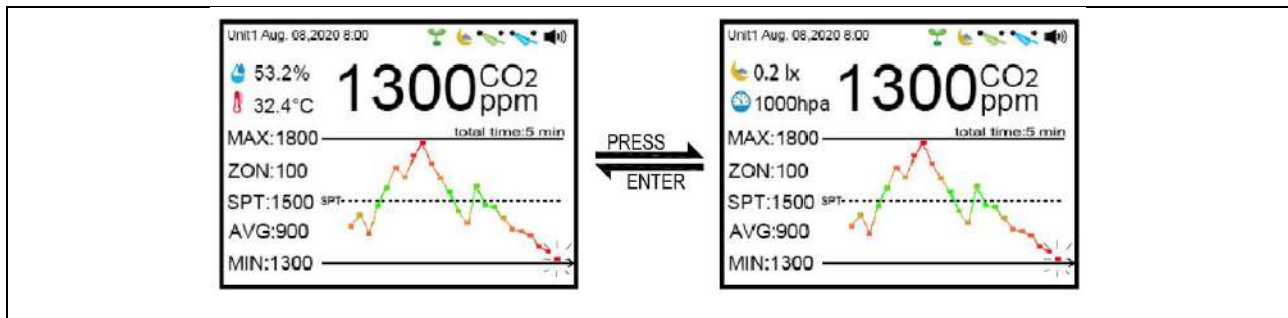

1. Press enter to switch the display between temperature + humidity and carbon dioxide + light

Change Table Time Range

In the main interface, press the Enter key for a long time to switch the time range in the CO2, temp and RH tables. The time range of each column in the table can be respectively 5 minutes (without CO2), 2 hours, 14 hours, 56 hours and 14 days (CO2 has a 5-minute trend)

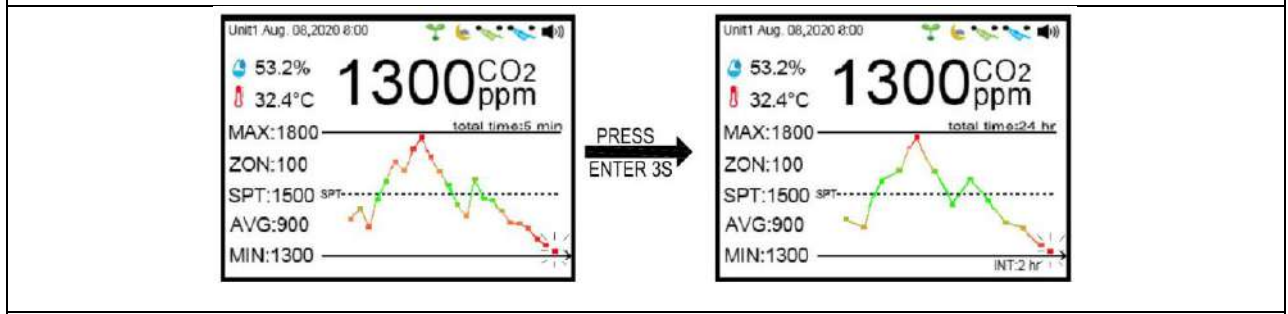

1. Long press enter for 3 seconds to switch table time range

Warning Message

When the measured value exceeds the range, it will be displayed “XXX is high”

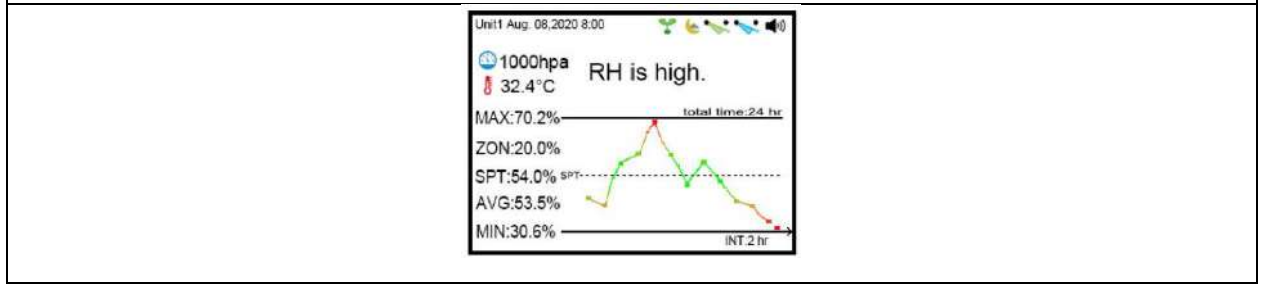

Access Menu

1. Press and hold the mode key for 3 seconds to enter the setting interface

Menu Options

Help:	Access help guide. Define key terms.
CO2:	Configure CO2 control options.
TEMP:	Configure Temp control options.
RH:	Configure RH control options.
Light:	Configure Light control options.
Time:	Set device time. Year: Date: Time:
Relay & Display:	Configure relay settings.
Buzzer:	Configure high “alarm” buzzer settings. <i>*NOT FOR SAFETY*</i>
Calibration:	Use to calibrate CO2, Temp, RH or Light of sensors. (See Calibration)
Recovery Setting:	Factory rest settings. Restore device to out of box state. YES/NO

Access Help Menu

1. Press and hold the mode key for 3 seconds to enter the setting interface
2. Press enter to enter help setting or long press mode to return to the main interface
3. Press up or down to find the information you need

Relay Function Selection



1. Press and hold the mode key for 3 seconds to enter the setting mode
2. Press the up or down key to select Relay & Display or long press the mode key for 3 seconds to return to the main display mode
3. Press enter to enter the setting interface of Relay & Display
4. Press enter to enter the Relay 1(Unit 1) setting or press mode to return
5. Press up or down to select whether to Temp or press mode to return
6. Press enter to confirm or press mode to cancel

Relay & Display Access and Selection



1. Press and hold the mode key for 3 seconds to enter the setting menu
2. Press the up or down key to select Relay and press enter
3. Press up or down to navigate setting and enter to select
4. Press the up and down keys to edit the setting
5. Press enter to confirm the setting or press mode to cancel the setting

Relay & Display Options

Relay 1 (Unit 1):	(CO2/Temp/RH/Light) Choose what value controls the relay
Relay 2 (Unit 2):	(CO2/Temp/RH/Light) Choose what value controls the relay
Sensor Choice:	(Unit 1/Unit 2) Choose controlling sensor if in single sensor mode
Relay Channel:	(Single/Double) Choose is one or both relays are active
Sensor Mode:	(Single/Double) Choose is one or both sensors trigger relays
Show All:	(Enable/Disable) Show all reading on main display
Show All Interval:	Interval of rotation of readings on main display
Backlight Mode:	(Auto/ON) Backlight Auto off or ON
Backlight Time:	Backlight Auto off timer

CO2 Settings

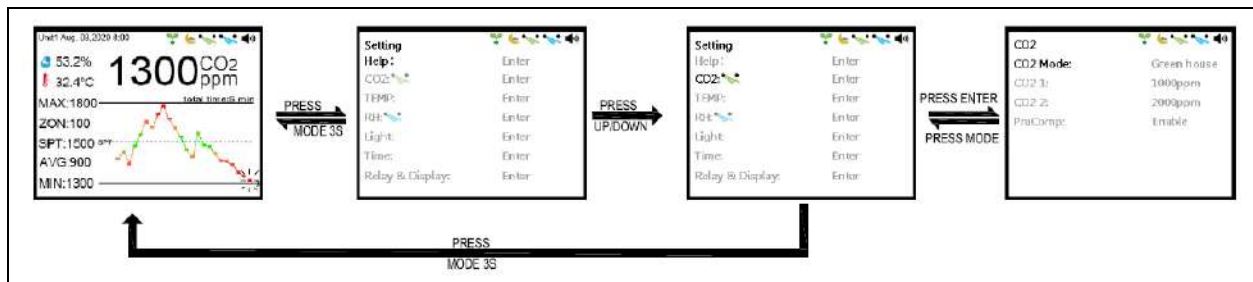

1. Press and hold the mode key for 3 seconds to enter the setting interface
2. Press the up or down key to select CO2 or long press the mode key for 3 seconds to return to the main display mode
3. Press enter to enter CO2 setting or long press mode to return to the main interface
4. Press the mode key to return to the setting interface or long press the mode key for 3 seconds to return to the main interface

CO2 Setting Options

CO2 Mode:	(Green House/HVAC) Choose green house or HVAC mode <i>HVAC = Mushroom Mode</i>
CO2 1:	Low CO2 Threshold Setting. Device acts to maintain CO2 above this point.
CO2 2:	High CO2 Threshold Setting. Device acts to maintain CO2 below this point.
PruComp:	(Enable/Disable) Turn pressure compensation ON/OFF

CO2 Calibration

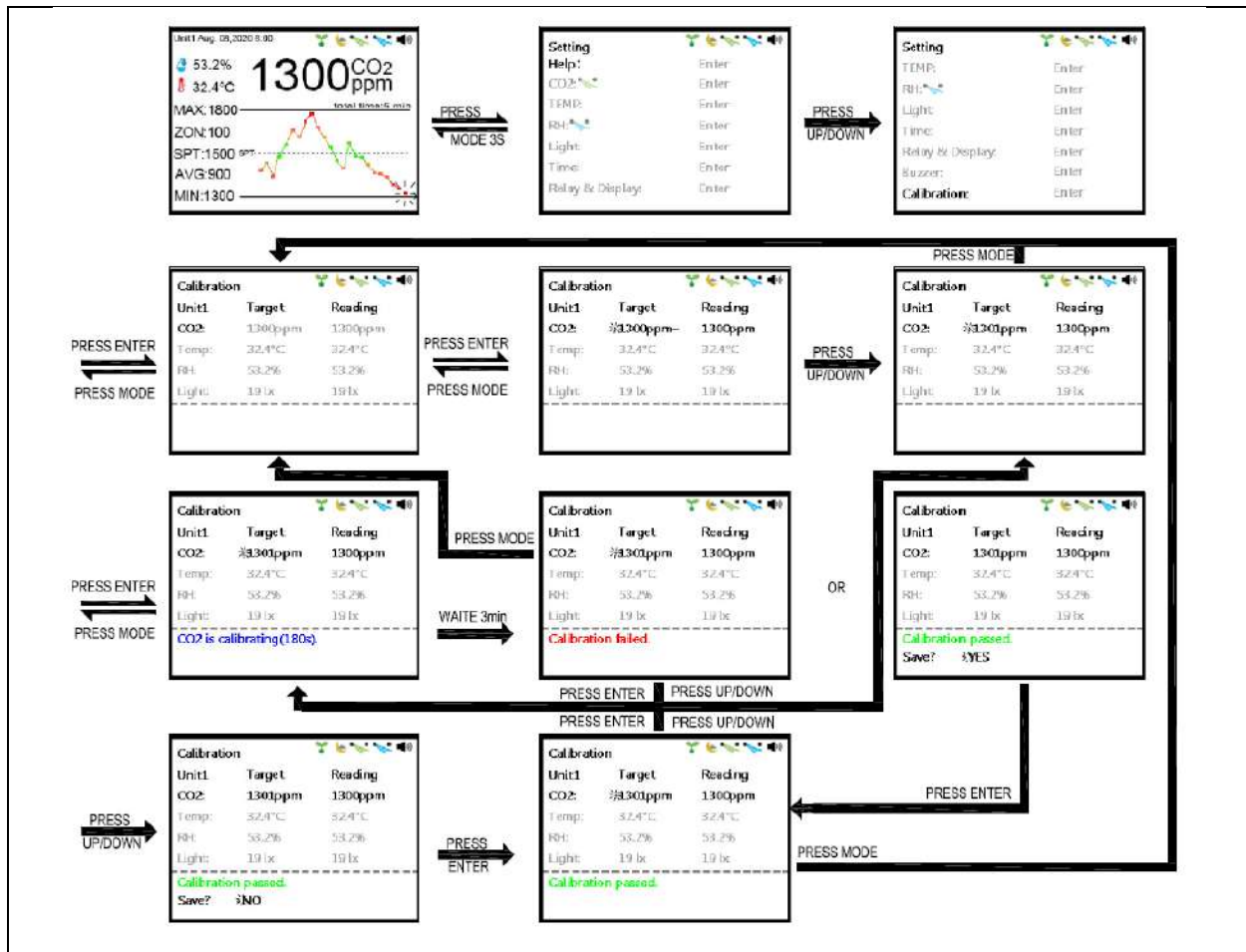

1. Press and hold the mode key for 3 seconds to enter the setting mode
2. Press the up or down key to select calibration and press enter
3. Press enter to select the CO2 calibration mode
4. Press the up or down key to set the target value. (0ppm for Nitrogen Calibration)
5. Flow 100% Nitrogen into the sensor port on Unit 1.
6. Press and hold the Enter key to start the calibration
7. Wait for 3 minutes for the calibration to finish or press the mode key to exit the calibration
8. After correction, press up or down to choose save or not save

Note: Only the sensor unit connected to the first channel can be calibrated. The calibration parameters are saved in the sensor unit itself. Please connect the sensor unit 2 to first channel for calibration when it's needed.

Temp or RH Settings

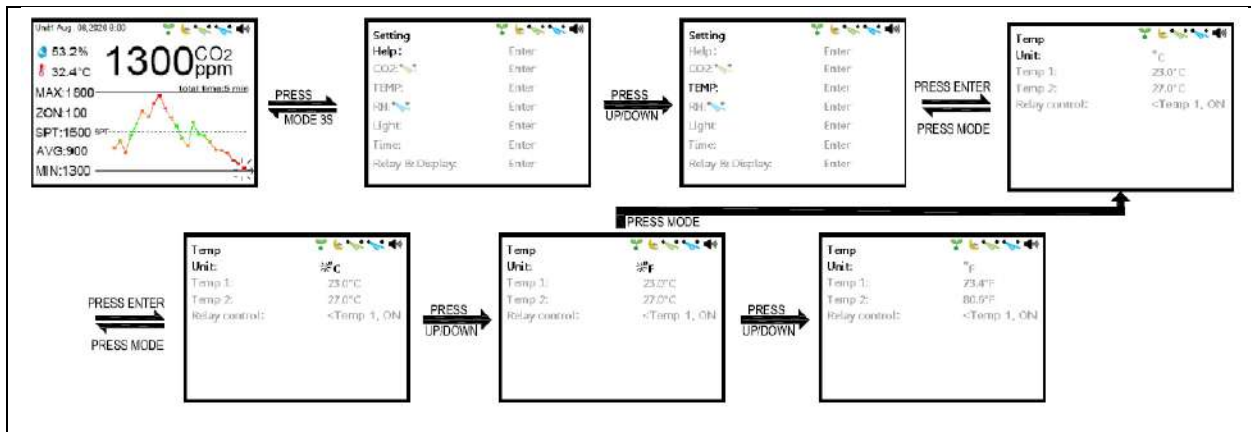

1. Press and hold the mode key for 3 seconds to enter the setting mode
2. Press the up or down key to select Temp/RH or long press the mode key for 3 seconds to return to the main display mode
3. Press enter to enter the setting interface of Temp
4. Press enter to enter the temperature unit setting interface or press mode to return
5. Press up or down to select the temperature unit or press mode to return
6. Press enter to confirm the setting or mode to cancel the setting

Temp Setting Options

Unit:	(C/F) Choose Celsius or Fahrenheit
Temp 1:	Low Temp Threshold Setting. Device acts to maintain Temp above this point.
Temp 2:	High Temp Threshold Setting. Device acts to maintain Temp below this point.
Relay Control:	(<Temp 1 / >Temp 2) Select Relay control logic. Relay to trigger when temp is greater than Temp 1 or less then Temp 2

RH Setting Option

Unit:	(C/F) Choose Celsius or Fahrenheit
RH 1:	Low RH Threshold Setting. Device maintains RH above this point
RH2:	High Temp Threshold Setting. Device maintains RH below this point
Relay Control	(<RH 1 / >RH 2) Select Relay control logic. Relay to trigger when temp is greater than RH 1 or less then RH 2

Light Settings

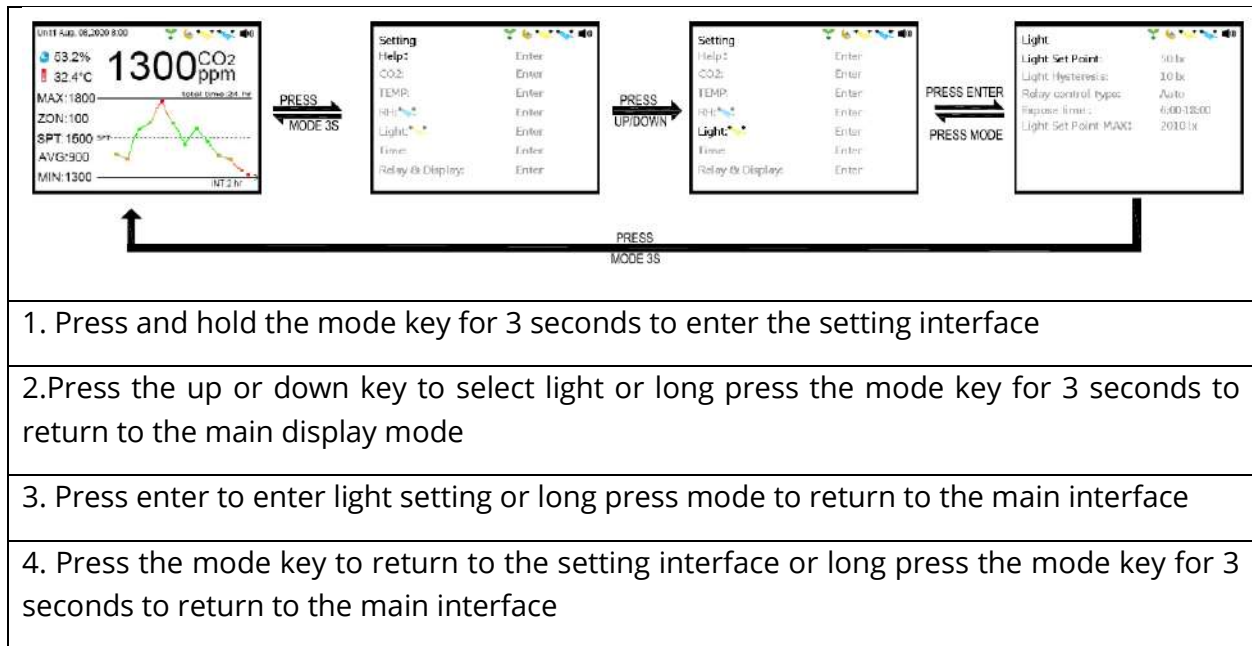

Light Setting Options

Light Set Point:	Set target light set point with up or down arrow
Light Hysteresis:	Set hysteresis value with up or down arrow
Relay Control Type:	(Auto/Manual) Auto is based on photo sensor; Manual is triggered by set points
Expose Time:	Set exposure time
Light Set Point MAX:	Set highest light point

Time Settings

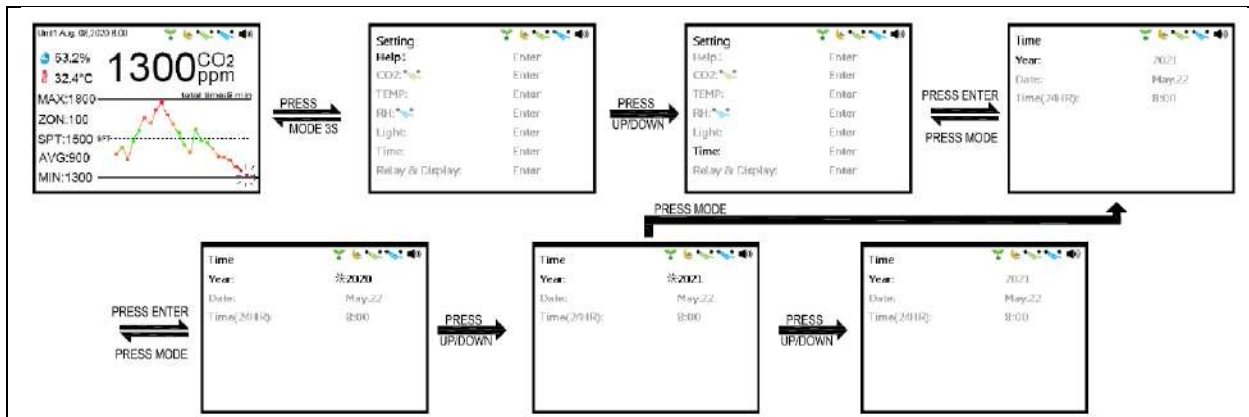

1. Press and hold the mode key for 3 seconds to enter the setting mode
2. Press the up or down key to select time or long press the mode key for 3 seconds to return to the main display mode
3. Press enter to enter the setting interface of time
4. Press enter to enter the year setting or press mode to return
5. Press the up or down key to set the desired value or press mode to return
6. Press enter to confirm the setting or mode to cancel the setting

Display and Backlight Sleep Settings

This product can choose to turn on or off the cyclic display and backlight sleep, select "Enable" when the cyclic display needs to be turned on, select "Disable" when the cyclic display needs to be turned off, select "auto" when the backlight needs to be turned on, and select "on" when the backlight does not need to be turned on.

The following operation is an example of Cycle display setting:



1. Press and hold the mode key for 3 seconds to enter the setting mode

2. Press the up or down key to select display or long press the mode key for 3 seconds to return to the main display mode
3. Press the up or down key to select Show All , or press mode to return
4. Press enter to enter the setting interface of display
5. Press enter to enter show all or press mode to return
6. Press the up or down key to select Enable or Disable , or press mode to return
7. Press enter to confirm the setting or mode to cancel the setting

This product can set cycle display and backlight sleep time

The following operation is an example of cycle display time setting



1. Press and hold the mode key for 3 seconds to enter the setting mode
2. Press the up or down key to select display or long press the mode key for 3 seconds to return to the main display mode
3. Press enter to enter the setting interface of display
4. Press the up or down key to select show all interval or press mode to return
5. Press enter to enter show all interval
6. Press the up or down key to set the desired value or press mode to return
7. Press enter to confirm the setting or mode to cancel the setting

Buzzer Settings

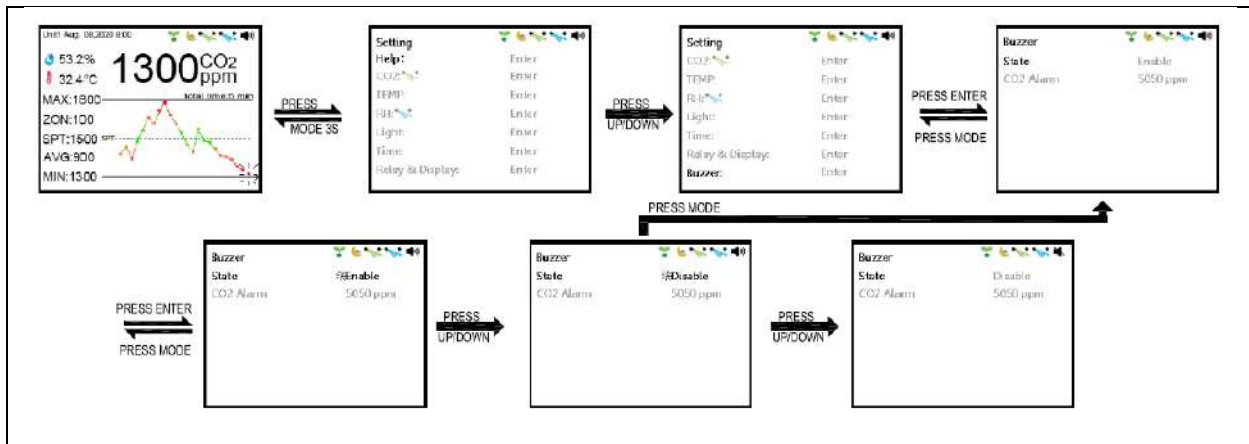

1. Press and hold the mode key for 3 seconds to enter the setting mode
2. Press the up or down key to select time or long press the mode key for 3 seconds to return to the main buzzer mode
3. Press enter to enter the setting interface of buzzer
4. Press enter to enter the state setting or press mode to return
5. Press the up or down key to select whether to turn on the buzzer alarm
6. Press enter to confirm the setting or mode to cancel the setting

Recovery Setting (Factory Reset)



1. Press and hold the mode key for 3 seconds to enter the setting mode

2. Press the up or down key to select recovery setting or long press the mode key for 3 seconds to return to the main display mode
3. Press enter to enter recovery setting
4. Press the up or down key to select yes , or press mode to return
5. Press enter to confirm the setting or mode to cancel the setting

Clear Calibration Values



1. Press and hold the mode key for 3 seconds to enter the setting mode
2. Press the up or down key to select calibration or long press the mode key for 3 seconds to return to the main display mode
3. Press enter to enter calibration setting
4. Press the up or down key to select clear or press the mode key to return
5. Press enter to enter clear setting
6. Press the up or down key to select yes , or press mode to return
7. Press enter to confirm the setting or mode to cancel the setting

Maintenance

The RAD-0502 is a low maintenance monitor that requires little maintenance after initial installation. It is recommended to calibrate the internal NDIR CO2 Sensor annually. This calibration can be completed in the field, or the monitor can be returned to CO2Meter to perform the calibration. A calibration certificate will be provided with every calibration service. Be sure to ask a CO2Meter technician for more information.

Warranty

CO2Meter warrants the products to be substantially free of defects in workmanship and materials when used for their intended purposes for a period of either one (1) year or ninety (90) days from the date of shipment of the applicable products as specified for each product on the individual product pages located at www.co2meter.com (the "Manufacturer's Limited Warranty"). No employee or representative of CO2Meter may alter the terms of the Manufacturer's Limited Warranty verbally or in writing.

To take advantage of the Manufacturer's Limited Warranty, the product must be returned to us at your expense. If after examination, we determine that the product is defective, CO2Meter at its election will repair or replace the defective product. The foregoing is the customer's exclusive remedy in the event of a valid warranty claim.

Notwithstanding anything contained herein, the Manufacturer's Limited Warranty shall not apply to: (i) any product that has been customized, altered, or repaired by any person not authorized to do so by CO2Meter; or (ii) any product that has been subject to misuse, neglect, or accidental damage. This warranty does not apply to calibration of any product.

In the event of an alleged warranty claim, you agree to contact us to request a return authorization prior to returning any products to us. We will only honor valid warranty claims of which we have been given notice prior to the expiration of the applicable limited warranty period. You agree to comply with all commercially reasonable rules and policies governing warranty claims which we may institute from time to time. Such rules and policies may be located at www.co2meter.com/pages/faq#warranty.

If you return a product to us, and we determine in our reasonable discretion that it falls within an exception to the Manufacturer's Limited Warranty as described herein, we will have no obligation to you other than to return the product(s) at your sole cost and expense.

It is our customer(s) responsibility to share your application with the CO2Meter sales team so they can help identify any potential issues your application may cause with our devices. Important information to share will be: expected CO2 concentration, temperature, humidity, and any other particles or gases in your application. Applications with interfering gases can damage our sensors and devices. Those applications with high humidity can damage the electronics and the CO2 sensors beyond repair.

Product Returns

If any Product fails under normal use, you may return it to us, by first submitting a customer case support ticket ([click here](#)). Policies and procedures for returns and refunds related to the same are located at www.co2meter.com/pages/faq.

All returns for refund after thirty (30) days from shipment of the applicable product will incur a 25% re-stocking fee. No product will be accepted for return or refund after 45 days from shipment.

Non-refundable clause, if a product is refunded, and your purchase included a calibration certificate charge, due to the calibration being a service, not an actual product item your refund will not include the certification charge in your refund.

Support

If the User Manual/Installation guide above does not contain the needed operation, installation or trouble shooting information, please contact CO2Meter at:

Support@CO2Meter.com

Contact Us

We are here to help! For information or technical support, please contact us using the information below. For further guidelines on CO2Meter Terms & Conditions, [click here](#).

✉ support@co2meter.com

☎ (386) 256-4910 (Technical Support)

☎ (386) 872-7665 (Sales)

🌐 www.CO2Meter.com



CO2Meter

105 Runway Drive
Ormond Beach, FL
32174 USA
877-678-4259
M-F 8:30am-5pm EDT

