



USER MANUAL



Multi Gas Safety System Manual

CM-7000 Series

Revision 5

Contents

Product Overview	4
The device includes the following key features:.....	5
Components	5
Accessories	6
System Specifications	6
System Electrical/Mechanical	6
Dimensions.....	6
CM-7005 Multi Gas Safety System Tablet	7
CM-7003 Multi Gas Safety System CO2 Sensor	7
CM-7103 Multi Gas Safety System O2 Sensor	7
CM-7004 Multi Gas Safety System Horn Strobe	7
CM-7002 Multi Gas Safety System Relay.....	7
CBL-7002 Multi Gas Safety System Relay Cable	7
CM-7006 Multi Gas Safety System Mini Display.....	8
CM-7007 Wireless Data Connector **COMING SOON**	8
CAT5e Cables.....	8
CM-7009 POE Injector.....	8
CM-1026-6 Gas Safety Strobe Tower.....	8
CM-1026-5 Gas Safety Strobe Tower.....	8
SV-1029 Solenoid Shut Off Valve	8
Installation	9
Wall Mounting Instructions:	9
CM-7005 Main Tablet, CM-7003 Sensor, CM-7002 Remote, and CM-7006 Mini Display Tablet...9	
Tablet Installation	10
CM-7003 CO2 Sensor Unit Installation	11
CM-7103 O2 Sensor Unit Installation	11
HornStrobe Installation.....	11
CM-7002 Remote Installation	11
CM-7007 Data Connector Installation	12
CM-7000 System Installation DO's and DON'Ts	13
<i>Installation DOs</i>	13
<i>Installation DON'Ts</i>	13

Displays Explained	14
Main Sensors Page	14
Main Groups Page (Without any Groups Create)	15
Main Groups Page (With Groups Create)	15
Individual Sensor Page	16
Individual Remote Page	17
Individual Data Connector Page.....	18
System Settings Page	18
Individual Group Page.....	20
Group Alarm Settings.....	20
Operation	21
Verify Firmware Version	21
Unlocking Tablet	22
Option 1: Unlock from System Settings Page	22
Option 2: Unlock from the Sensor Page.....	23
Adjusting Alarm Settings.....	24
Group Configuration	25
Creating Group.....	25
Adding Sensors to a Group	26
Adjusting Group Settings	27
Relay Operation and Connection (CM-7005 & CM-7002)	28
Tablet Relay Operation	28
Tablet Relay Connection	28
Remote Relay Operation.....	29
Remote Relay Connection (CBL-7002)	29
Calibration.....	30
Safety Notice	31
Product Care	31
Support and Contact Info.....	Error! Bookmark not defined.



Product Overview

Thank you for selecting the CO2Meter Multi Gas Safety System Series.

The CM-7000 Multi Gas Safety System was designed to monitor, detect, and control the levels of carbon dioxide or oxygen concentrations in a given environment. Because these gases are colorless and odorless, they can be dangerous to employees and customers when they are present in high concentrations. High concentrations in confined spaces are dangerous and may lead to negative health problems, including headaches, fatigue, asphyxiation, or even fatality.

With the Multi Gas Safety system it ensures individuals, staff, and facilities are safe and protected. Should an incident occur, you can rely on the device's ability to trigger an exhaust fan or send an immediate alarm to the fire department or monitoring company.

The CM-7000 features a multitude of sensor configurations with the option of pairing programmable relays. These relays are preset to be triggered at 5,000ppm TWA, 5,000ppm, 1.5%, and 3% (CO₂) to meet OSHA/NIOSH standards. As well as 19.5%, 16.5% and 12% (O₂) to meet OSHA and CGA standards.

(COMING SOON**)**

Enhance the safety of your operation by adding a Wireless Data Connector and get instant push notifications to your mobile devices in the event of an alarm. You can

also check in every hour to make sure your building and rooms are safe and connected.

With the CM-7000 Multi Gas Safety System, you can ensure you and your employees are safe, protected, and compliant with gas safety standards.

Multi Gas Safety System Features:

- Full color, 8" Touchscreen Display
- Expandable Sensor Array with up to 12 sensors + horn strobes (Expandable up to 16 Sensors with the assistance of a CM-7000 Specialist)
- Measures 0-5% CO₂
- Measure 0-23% O₂
- Individually addressable sensors and groups
- User configurable settings
- Selectable CO₂ alarms ranging from 5000ppm TWA, 5000ppm, 1%, 1.5%, 2%, 2.5%, 3%, 3.5%, 4% (configurable)
- Selectable O₂ alarms ranging from 20%, 19.5%, 19%, 18.5%, 18%, 17.5%, 17%, 16.5%, 16%, 15.5%, and 15% (configurable)
- Lock/unlock code for complete system security.
- Audible/Visual Alarms

Multi Gas Safety System Parts/Components

- **CM-7001 - Sensor and Horn/Strobe Combo Package** - The Sensor and Horn/Strobe Combo Pack provides additional sensing capabilities for customers who require additional sensors and strobes per industry or application. *(Discontinued)*
- **CM-7002 - Multi Gas Safety System Relay** - The Remote Relay unit allows customers to add remotely addressable relays to a group.
- **CM-7003 - Multi Gas Safety System CO₂ Sensor** - The CO₂ sensor unit designed to detect Carbon Dioxide anywhere it is stored or used in manufacturing.
- **CM-7103 - Multi Gas Safety System Oxygen Sensor** - The O₂ sensor unit designed to detect Oxygen anywhere it is stored or used in manufacturing. If a leak of any inert gas occurs, especially Nitrogen, the sensor unit can detect that there is a lack of oxygen, even at extreme temperatures.

- **CM-7004 – Multi Gas Safety System Horn Strobe** - Additional Horn/Strobes can be purchased per industry or application dependent upon customer needs and requirements. Amber lens is included, blue lens is available for purchase.
- **CM-7004-OUT – Multi Gas Safety System Exterior Horn Strobe** - Additional outdoor Horn/Strobes can be purchased per industry or application dependent upon customer needs and requirements. Amber lens is included, blue lens is available for purchase.
- **CM-7005 – Multi Gas Safety System Tablet** - 8"-inch touch screen control panel.
- **CM-7006 – Multi Gas Safety System Mini Display Tablet** – The secondary tablet designed for remote display only. The gas readings and safety alarm status mirror to this display for viewing purposes. *Note: The CM-7006 is for viewing only. This tablet does not offer control of the system.
- **CM-7007 – Multi Gas Safety System Wireless Data Connector (**COMING SOON**)** – View all of your tablet's sensor data remotely and get alerts from sensor alarms with the new CO2Meter App paired with a Wireless Data Unit.
- **CM-7009 - POE Power Injector-** Secondary POE injector used to increase the power capabilities of the CM-7000 system. Has the ability to increase the quantity of add-ons and the length of daisy chains.

Accessories

- **CBL-7002 - Reset Unit Relay Cable** - The relay cable provides ease of access and connection to the relays housed in the CM-7002 Remote unit. This cable can be used to wire to the CM-1026-5,6 Strobe Towers and SV-1027 Solenoid Valve.
- **CM-1026-5/CM-1026-6 - CO2 Storage Safety Strobe Tower-** designed to provide a flashing indicator, and audible alarm with any of our CM-7000 systems.
- **SV-1028 - Solenoid Safety Shut Off Valve** - designed to be utilized with our CM-7000 Multi Gas Safety System, and can be directly wired to the SV-1028 24VDC safety shut-off valve via main tablet or sensor unit relays.
- **ADP-7000 – Replacement Power Supply** – In the event of damage to the included CM-7005 power supply. The ADP-7000 is the required replacement.

System Specifications

System Electrical/Mechanical

- Power Input: 48-58VDC
- Power Consumption: 3-30W
- Power Consumption: 300mA peak, 30mA average

Dimensions

- CM-7005 (Main Tablet): 8.0" w x 8.75" l x 1.5" h (Screen is 8" LCD touchscreen)

- CM-7002 (Remote Unit): 3.5" w x 5.5" l x 1.75" h
- CM-7003 (Sensor): 3.5" w x 5.5" l x 1.75" h
- CM-7004 (Horn Strobe): 5.5" w x 4.5" l x 2.75" h
- CM-7006 (Mini Display Tablet): 5" w x 8.3" l x 2.75" h

CM-7005 Multi Gas Safety System Main Tablet

- 8" Capacitive Touchscreen
- (QTY-2) 1 Watt Speakers
- 48-54V DC Power Input
- (QTY-4) CAT5 Powered Ethernet Connector Ports
- CAT5 Un-Powered Uplink Ethernet Connector (Used for Troubleshooting Only)
- USB Type A Connector (Used for Troubleshooting and Updates Only)
- (QTY-3) 10A Relays

CM-7003 Multi Gas Safety System CO2 Sensor

- CO2 Measurement: Non-Dispersive Infrared (NDIR)
- CO2 Measurement Range: 0-5% (400-50,000ppm)
- Measurement Interval: 2 seconds
- Response time: 90% at 2 minutes
- Sensor Reading Frequency: 0.5Hz
- Sensor Life Expectancy: > 15 years
- Maintenance Interval: Annual Zero Calibration
- Connections: Input / Output / Strobe - CAT5 8 pin Connector

CM-7103 Multi Gas Safety System Oxygen Sensor

- O2 Measurement: Zirconium Oxide (ZR)
- CO2 Measurement Range: 0-23%
- Measurement Interval: 2 seconds
- Response time: 90% at 10 minutes
- Sensor Reading Frequency: 0.5Hz
- Sensor Life Expectancy: > 10 years
- Maintenance Interval: Annual Ambient Calibration
- Connections: Input / Output / Strobe - CAT5 8 pin Connector

CM-7004 Multi Gas Safety System Horn Strobe

- 110 Candela Amber Strobe
- 90-120dB 3KHz Temporal Horn
- Dual CAT5 Connector
- 6 ft CAT5e Cable

CM-7002 Multi Gas Safety System Relay

- (QTY-3) 2A Relays
- 25 ft CAT5e Cable
- Connections: Input / Output / Strobe - CAT5 8 pin Connector

CBL-7002 Multi Gas Safety System Relay Cable

- Screw terminal adapter cable
- End 1: RJ45 Male
- End 2: 8 Position Screw terminal Connector

CM-7006 Multi Gas Safety System Mini Display Tablet

- 7" Vertical Capacitive Touchscreen
- (QTY-1) CAT5 Powered Ethernet Connector Ports
- USB Type A Connector (Used for Troubleshooting and Updates Only)

CM-7007 Wireless Data Connector ****COMING SOON****

- Easy setup, uses Cellular Data (no need to connect to internal network or WiFi)
- Pushes all Sensor Data at 1-hour intervals
- Get Sensor Alarm notifications as soon as it happens with the CO2Meter Mobile App
- View Data in iOS / Android / Web
- Pay no monthly fees
- 3 years of free data and App usage (small re-connection fee after 3 years)
- Add additional users to view data at no cost
- Connections: Input / Output / Strobe - CAT5 8 pin Connector

CAT5e Cables

- 25ft length
- 6ft length
- T568B RJ45 Pinout

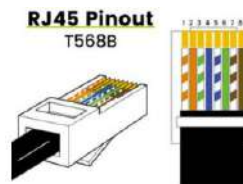

CM-7009 POE Injector

- Input:100-240VAC 50/60Hz
- Tablet Input: 48V 1.0A
- Data Rate: 10/1000Mbps

CM-1026-6 Strobe Tower

- 24 V DC
- 6' (2m) Cable included
- Length: 11.5" long
- Diameter: each 1.5"
- Alarms set to match 3 relays on RAD units (user configurable)
- Mounting bracket include

CM-1026-5 Strobe Tower

- 100-240AC
- 6' (2m) Cable included
- Length: 16" long
- Diameter: each 1.5"
- Alarms set to match 3 relays on RAD units (user configurable)
- Mounting bracket include

SV-1028

- Pipe Size: 1/8 inches NPT
- Max Operating Pressure: 130 psi
- Body Material: Brass
- Length: 1-15/64" x Width: 1-11/16" x Height: 2-51/64"
- IP Rating: 65
- UL Approved
- 24VDC

Installation

***** WARNING *****

Please carefully follow these instructions for a successful installation. If these instructions are not properly followed during installation, there is a high-risk additional troubleshooting will be required or system failure will occur.

***** WARNING *****

Wall Mounting Instructions:

Mount all parts of the CM-7000 system in place prior to wiring. Once all components are mounted in place, proceed to wiring.

CM-7005 Main Tablet, CM-7003 Sensor, CM-7002 Remote, and CM-7006 Mini Display Tablet

Step 1:

Use the included wall bracket to mark hole locations. Be sure to use included wall anchors for a secure mount.

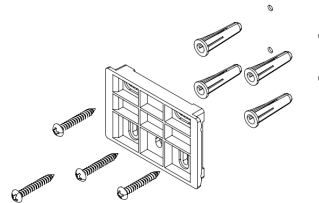

Step 2:

Install the bracket on the wall using all 4 anchors and all 4 screws intended for the bracket. Level before completely tightening to the wall

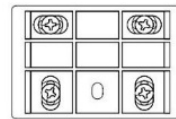

Step 3:

The same wall bracket is used for the CM-7002, CM-7003, CM-7005 and CM-7006. These components slide over the bracket to lock in place.

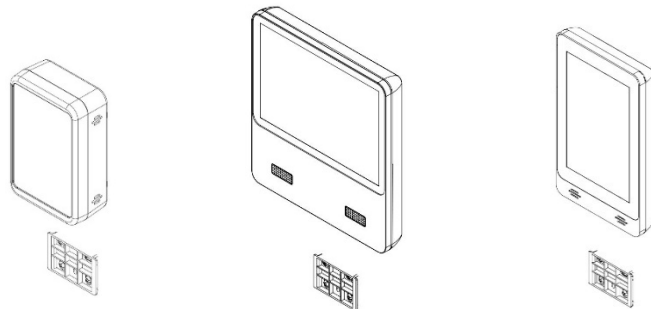

Step 4:

Simply center the component over the bracket, press against the wall, then slide the unit down until it locks in place.

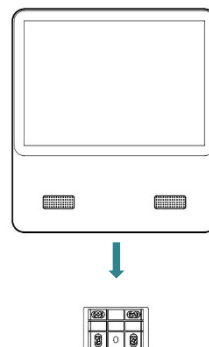

To remove from the bracket, simply slide up in the opposite direction.

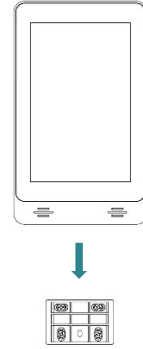

***** WARNING *****

Please carefully follow these instructions for a successful installation. If these instructions are not properly followed during installation, there is a high-risk additional troubleshooting will be required or system failure will occur.

***** WARNING *****

Tablet Installation

** Please Note: The Tablet Mounting Bracket should be installed at eye level, outside the location of CO2.*

Step 1. Follow wall mounting instructions previously mentioned.

Step 2. Plug green screw terminal power connector into Tablet and secure with screws.

Step 3. Slide the CM-7005 8" tablet onto the mounting bracket.

Step 4. Plug the Power Adapter into an Outlet and verify the Tablet turns ON.

Step 4. Begin daisy chain connection of CM-7003 and CM-7002 units. Connect them **ONE AT A TIME** using port 1-4 on the back of the tablet. (See diagram on page 10)

Back of CM-7005 Multi Gas Safety System Tablet

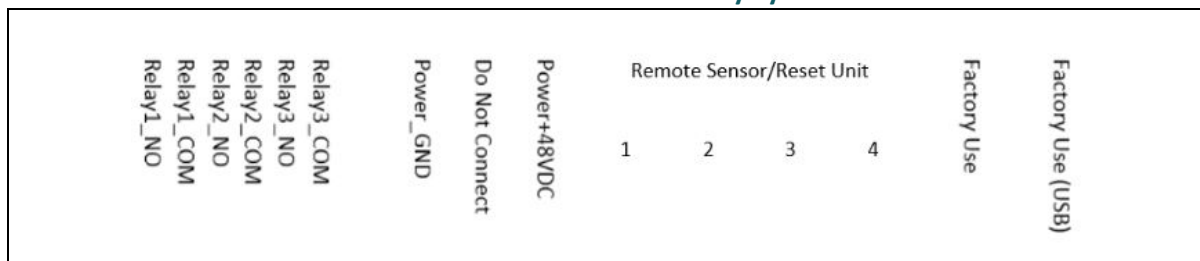

*****DO NOT MOVE ON TO CONNECT THE NEXT UNIT UNTIL THE PREVIOUS IS DISPLAYED ON THE MAIN SENSOR PAGE OF THE TABLET*****

CM-7003 Multi Gas Safety CO2 Sensor Installation

** Please Note: The sensor unit should be mounted 12". off the floor, near the CO2 source.*

** Please Note: The maximum distance (Cable Length) a unit can be placed from the tablet is 250'.*

** Please Note: Connect Sensors to tablet one at a time while tablet is powered.*

Step 1. Follow wall mounting instructions previously mentioned.

Step 2. Connect Ethernet cable from Tablet port 1-4 to Sensor Unit "Input" port.

Step 3. Green LED power indicator will activate on the Sensor Unit.

Step 4. Wait for the Sensor to display on the Main Sensor Page of the tablet.

Step 5. Press Sensor Unit against the wall, slide the unit down until it locks in place on the bracket.

Step 6. Name Sensor on Tablet

CM-7103 Multi Gas Safety System Oxygen Sensor Installation

** Please Note: The sensor unit should be mounted 6'. off the floor, near the N2 source.*

** Please Note: The maximum distance (Cable Length) a unit can be placed from the tablet is 250'.*

** Please Note: Connect Sensors to tablet one at a time while tablet is powered.*

Step 1. Follow wall mounting instructions previously mentioned.

Step 2. Connect Ethernet cable from Tablet port 1-4 to Sensor Unit "Input" port.

Step 3. Green LED power indicator will activate on the Sensor Unit.

Step 4. Wait for the Sensor to display on the Main Sensor Page of the tablet.

Step 5. Press Sensor Unit against the wall, slide the unit down until it locks in place on the bracket.

Step 6. Name Sensor on Tablet

CM-7004 Multi Gas Safety System Horn Strobe Installation

** Please Note: This Mounting Bracket is designed to be mounted on junction boxes if needed.*

Step 1. Remove Mounting Bracket, from back of horn strobe assembly.

Step 2. Mount the Horn Strobe Bracket to the wall.

Step 3. Place the CAT5 cable in the bottom port hole of the mounting bracket.

Step 4. Slide the front horn strobe cover to mounting bracket.

Step 5. Secure bracket and the horn strobe cover together with a tamper proof screw.

Step 6. Install Ethernet Cable to the Sensor Unit "Strobe" port.

CM-7002 Multi Gas Safety System Relay Installation

Step 1. Follow wall mounting instructions previously mentioned.

- Step 2. Connect Ethernet cable from Tablet port 1-4 to Remote Unit "Input" port.
- Step 3. Green LED power indicator will activate on the Remote unit.
- Step 4. Wait for the Remote to display on the Main Sensor page of the tablet.
- Step 5. Press Remote against the wall, slide the unit down until it locks in place on the bracket.
- Step 6. Name Remote on Tablet

CM-7007 Multi Gas Safety System Wireless Data Connector Installation

- Step 1. Follow wall mounting instructions previously mentioned.
- Step 2. Connect Ethernet cable from Tablet port 1-4 to Remote Unit "Input" port.
- Step 3. Green LED power indicator will activate on the Remote unit.
- Step 4. Wait for the Data Connector to display on the Main Sensor page of the tablet.
- Step 5. Press Data Connector against the wall, slide the unit down until it locks in place on the bracket.
- Step 6. Name Remote on Tablet
- Step 7. Using the CO2Meter Mobile App, Add Device and Scan the on-screen QR-Code

Example:

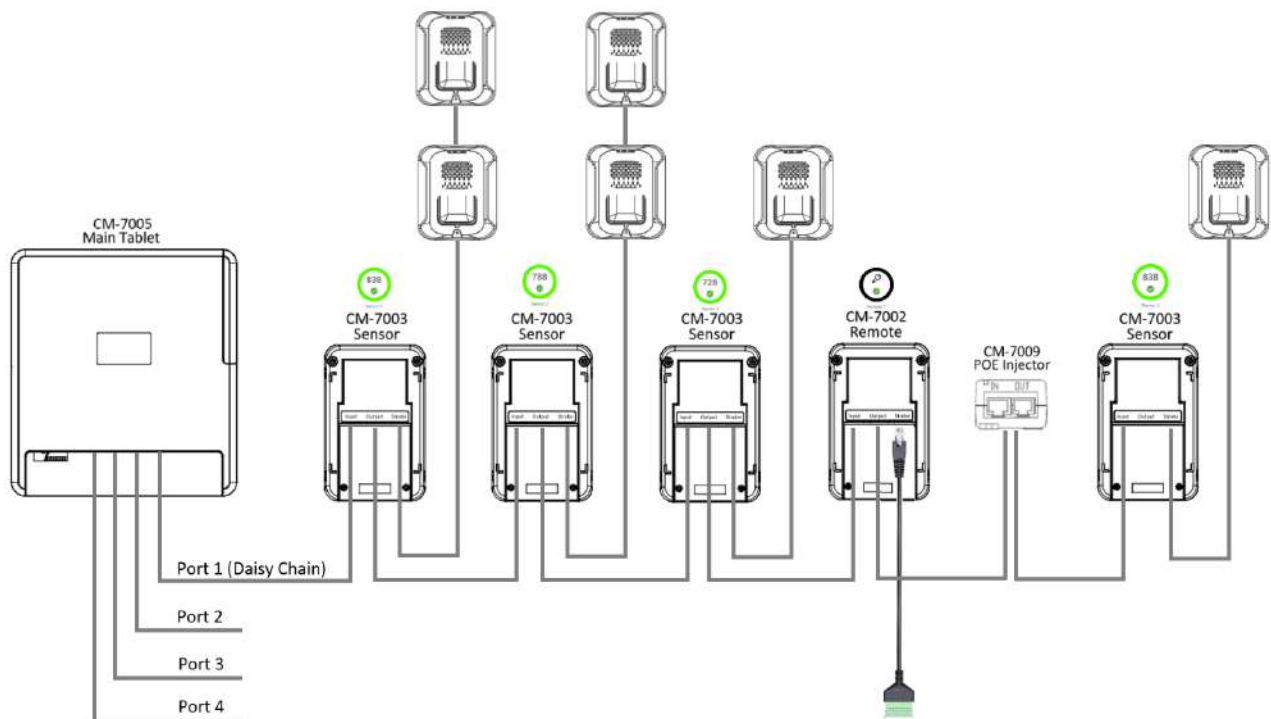

CM-7000 Multi Gas Safety System Installation DO's and DON'Ts

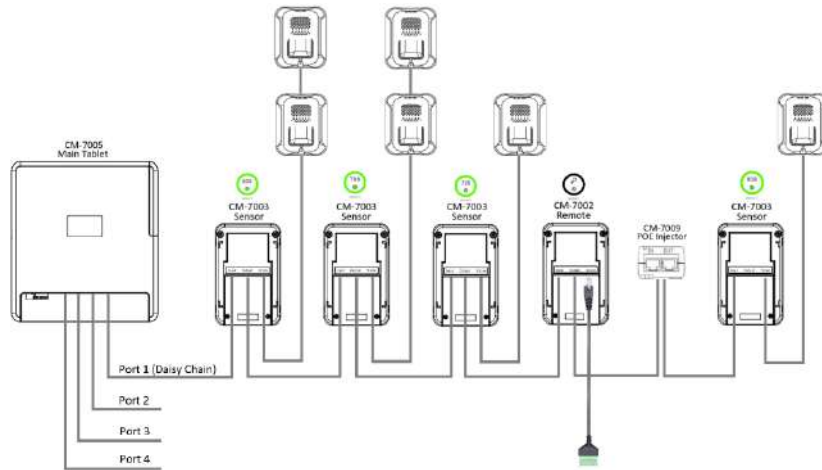

Installation DOs

- **DO Power on the CM-7005 Main tablet prior to connecting CM-7003 / CM-7103 Sensors, CM-7002 Remotes, or CM-7007 Wireless Data Connector**
 - Power on the tablet before connecting sensors or remotes. Make sure the main sensor page loads prior to connecting additional units. Once the Sensor page loads, continue to connect sensors and remotes one at a time.
- **DO Connect Sensors and Remotes one at a time.**
 - **Sensors and remotes must be connected one at a time. Connect a sensor and unit, then wait until the unit is displayed on the tablet. Do not move on to connect the next unit if the previous has not yet shown up on the tablet.**
- **DO Connect Strobes to each other using the ports located in the strobe mounting Bracket.**
 - Strobe to Strobe connection is acceptable when using the built-in splitter found in the mounting bracket of the strobe.
- **DO Name Sensors and Remotes as they are connected to the CM-7000 System**
 - For easiest setup, name the sensors and remotes when they are connected and displayed on the main sensor page of the tablet.

Installation DON'Ts

- **DON'T Connect more than (5) CM-7004 Horn Strobes PER PORT without the addition of a CM-7009 POE Power Injector (This is considered advanced installation. Contact CO2 Meter for advanced installation instructions)**
 - If more than 5 CM-7004 horn Strobes are to be connected to a single port, a CM-7009 POE power injector is needed. If more than 5 horn strobes are connected to a single port, without the use of a power injector, the system will experience a power failure while in alarm status.
- **DON'T Connect more than (12) CM-7004 Horn Strobes PER TABLET without the addition of a CM-7009 POE Power Injector (This is considered advanced installation. Contact CO2 Meter for advanced installation instructions)**
 - If more than 12 CM-7004 horn Strobes are to be connected to a CM-7000 system, a CM-7009 POE power injector is needed.

- **DON'T extend a daisy chain longer than 250 ft without the addition of CM-7009 POE Power Injector**
 - If more than 5 CM-7004 horn Strobes are to be connected to a single port, a CM-7009 POE power injector is needed. If more than 5 horn strobes are connected to a single port, without the use of a power injector, the system will experience a power failure while in alarm status.
- **DON'T Use CAT5 Splicers or Splitter**
 - The CM-7000 System was not designed to be used with CAT5 splitters. The use of splitters will cause communications issues between the Tablet and sensors/remotes. *(This may cause sensor failure)*
- **DON'T Mount the Tablet in the Sensing area.**
 - The tablet should be mounted outside of the sensing area. In the event the CO2 storage area becomes compromised, tablet access may be necessary. Be sure the tablet is mounted in a safe place outside of the storage area.

Displays Explained

Main Sensors Page

- The Main Sensors page displays all devices that are connected to the CM-7000 system.
- The color ring around the sensor indicates the safety alarm status.
- Remotes are represented by black rings with key icons.
- **Green** = Safe
- **Yellow** = Caution
- **Red** = Danger
- Drop down arrow, located at the top center, by the title "Sensors" allows the user to navigate to the Main Groups page.
- Gear icon in the top right-hand corner allows access to the System Settings Page
- User can use the touch screen on the tablet to scroll through all Sensors and remotes

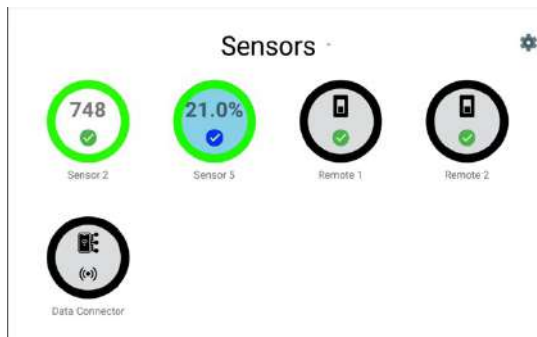

Main Groups Page (Without any Groups Create)

- The Main Groups page displays all groups created by the user.
- Groups are created to assign alarm configuration to multiple sensors and remotes. Each group will control all sensors and remotes added to it.
- Upon initial startup of a CM-7000 system, there will be only one group found on this page titled "Unassigned."
- The "Unassigned" group houses all sensors or remotes that have not yet been added to another group.



Main Groups Page (With Groups Create)

- The user can create groups as needed to separately control units of similar function or location.
- In the example image seen to the right, a group has been created to control the sensors and remotes connected to each port of the tablet, Ports 1-4.

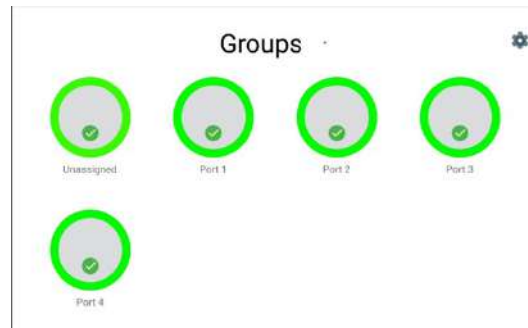

Individual Multi Gas Safety System CO2/O2 Sensor Page

- Press any sensor found on the Main Sensors page to open its individual configuration.
- The user can adjust the name and location of the unit.
- These settings and features must be unlocked using the password "co2meter" prior to changing them.
- Position can be selected to adjust the location of the sensor on the Main Sensors Page.

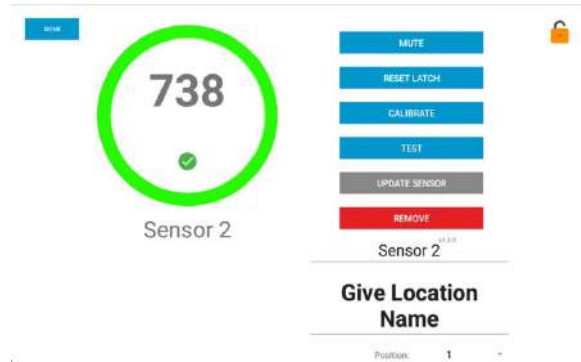

MUTE – Press this button to mute the sensor while in alarm status.

RESET LATCH – Press this button to reset a triggered latch after an alarm.

CALIBRATE – Press this button to begin a calibration of the sensor. 100% Nitrogen is needed to perform these zero calibrations.

TEST – Press this button to test the function of the strobe/s connected to the sensor.

- 1 Press – Tests strobe
- 2 Press – Tests horn
- 3 Press – Tests both strobe and horn
- 4 Press – End test

REMOVE – Press this button to remove the sensor from the main Sensors Page. This can only be done to an offline sensor.

*NOTE: CO2 & O2 are functionally the same on the sensor detail page

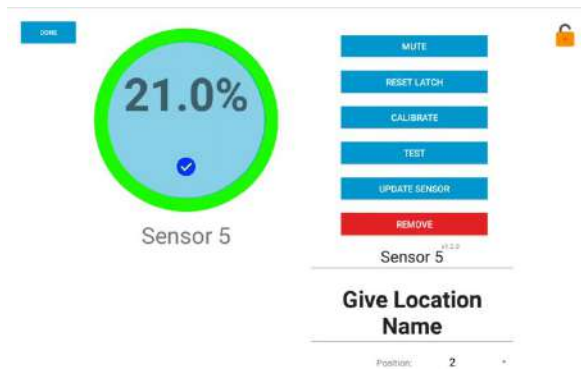

Individual Multi Gas Safety System Relay Page

- Press any Relay found on the Main Sensors page to open its individual configuration.
- The relays that are featured in the Remote Relay Unit are User customizable.
- Relay units feature 3 relays that can be set to inactive (normally open) or active (normally closed).
- The user can also adjust the name and location of the unit.
- These settings must be unlocked using the password "co2meter" prior to changing them.
- Position can be selected to adjust the location of the remote on the Main Sensors Page.

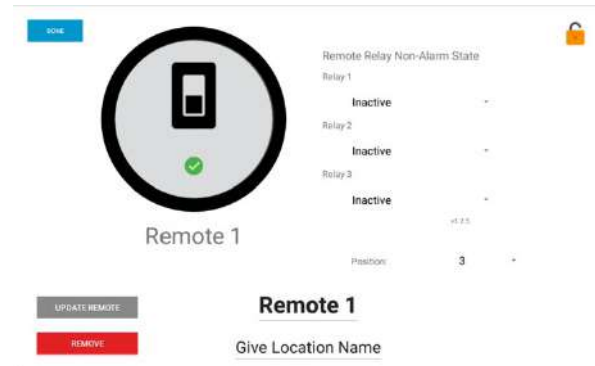

UPDATE REMOTE – Press this button to update the software of the Remote unit. If no update is available, the button will appear grey.

REMOVE – Press this button to remove the Remote from the Main Sensors Page. This can only be done to an offline sensor.

Individual Multi Gas Safety System Wireless Data Connector Page

- Press the Data Connector found on the Main Sensors page to open its individual configuration.
- The QR Code is available to add to the organization through the CO2Meter Mobile App
- The user can also adjust the name and location of the unit.
- These settings must be unlocked using the password “co2meter” prior to changing them.
- Position can be selected to adjust the location of the remote on the Main Sensors Page.



UPDATE DATACONNECTOR – Press this button to update the software of the Data Connector unit. If no update is available, the button will appear grey.

REMOVE – Press this button to remove the Remote from the Main Sensors Page. This can only be done to an offline sensor.

System Settings Page

- The System Settings page provides access to the Tablet relays, the ability to create groups, reset functionality and the user manual.
- These settings and features must be unlocked using the password “co2meter” prior to changing them.

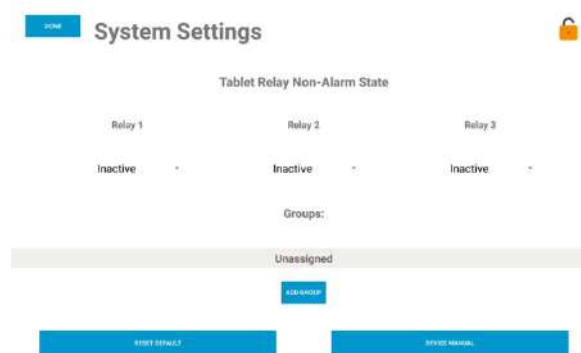

- The Tablet Firmware Version can be found by scrolling to the bottom of this page.
- The Firmware Version is the most important piece of information needed while troubleshooting your CM-7000 System.
- The Tablet Firmware Version at the time of this writing V2.1.9



- The lock icon in the top right-hand corner
- These settings must be unlocked using the password "co2meter" prior to changing them.

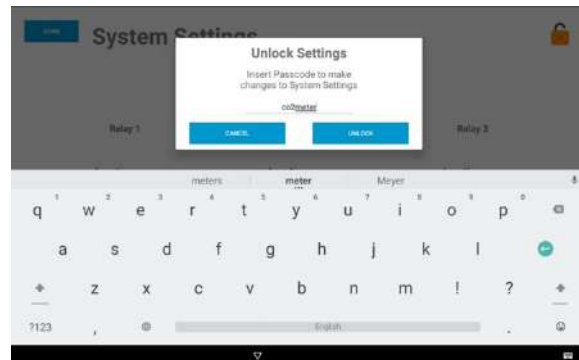

Individual Group Page

- Press any Group found on the Main Groups page to open it individually.
- The Individual Group page will display all sensors and remotes that have been assigned to that group.
- The Gear icon in the top right-hand corner will allow access to the that group's settings page.



Group Alarm Settings

- The Group Alarm Settings page allows the user to configure all alarm settings for that group.
- Alarm 1-4 can all be customized on this page for that group.
- Switch between CO2 Alarms and O2 alarms by selecting the CO2 / O2 dropdown in the top left.
- An offline alarm can be set from this page to indicate if a sensor or remote goes offline and fails to communicate with the tablet.
- Other settings like Mute, tablet volume and latch can be configured on this page



- The bottom of this page offers a list of all sensors and remotes assigned to this group along with the option to add additional sensors or remotes.
- A reset to default button is the last option on this page, this button allows the user to reset the Group settings for this individual group. No other groups will be altered with this button

Operation

Verify Firmware Version

To best service your CM-7000 Multi CO2 Sensor system, it is important to first verify what version of firmware your system is operating. To locate this information please follow the following steps:

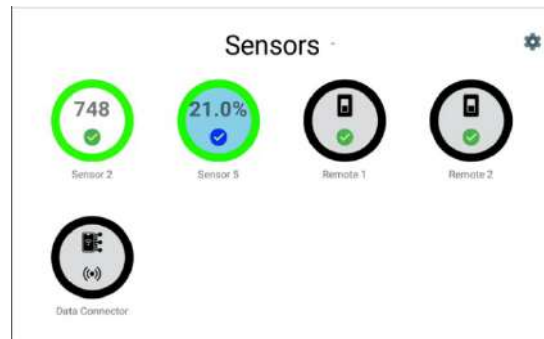

Step 1: Power on your CM-7000/CM-7005 Tablet and navigate to the main sensor page. This page displays all sensors and remote units that are connected.

Step 2: Press the settings icon located in the top right corner of the display. This will open the system settings page on your tablet.

Step 3: Use the touchscreen to scroll to the bottom of the page.

Step 4: The version of firmware will be displayed.

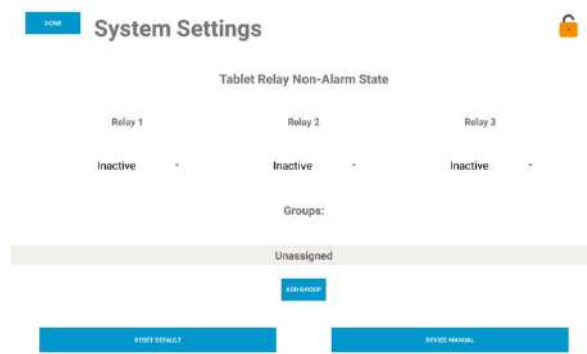

Unlocking Tablet

To update alarms or relay configuration, the CM-7000 system must first be unlocked. There are many pages that display a lock icon that can be selected, this selection will open a prompt allowing the user to enter the password "co2meter" to unlock the device. Please see the below images of the multiple locations that allow you the user to enter the password for configuration.

Option 1: Unlock from System Settings Page

Step 1: Navigate to the main sensor page. This page displays all sensor and remote units that are connected.

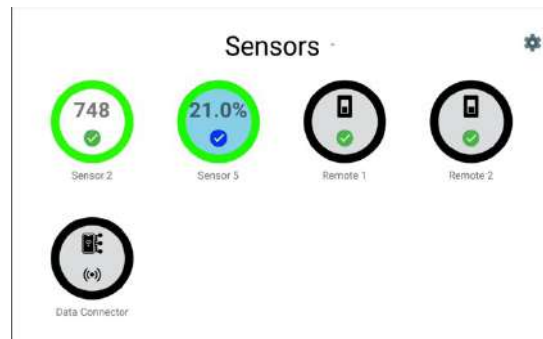

Step 2: Press the setting icon located in the top right-hand corner of the display. This will open the system settings page on your tablet.

Step 3: Press the lock icon in the top right-hand corner of the display.

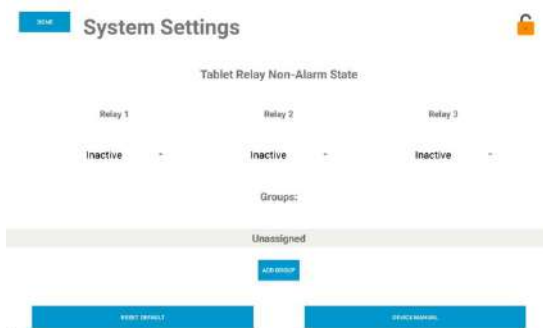

Step 4: The user will be prompted to "Insert Passcode to make changes to System Settings"

Step 5: Enter the password "co2meter" all lower-case letters.

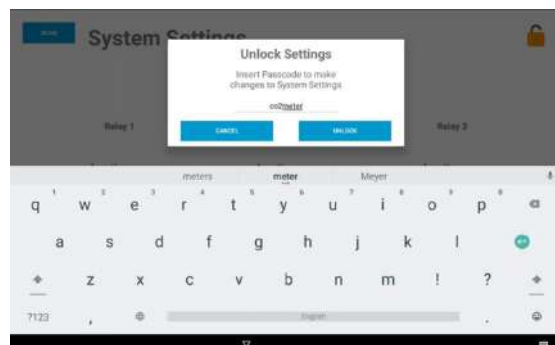

Step 6: Press unlock. This will unlock the technician access for 10 minutes.

Option 2: Unlock from the Sensor Page

Step 1: Navigate to the main sensor page. This page displays all sensor and remote units that are connected.

Step 2: Press on a sensor icon on the display. This will open the sensor page on your tablet.

Step 3: Press the lock icon in the top right-hand corner of the display.

Step 4: The user will be prompted to "Insert Passcode to make changes to System Settings"

Step 5: Enter the password "co2meter" all lower-case letters.

Step 6: Press unlock. This will unlock the technician access for 10 minutes.

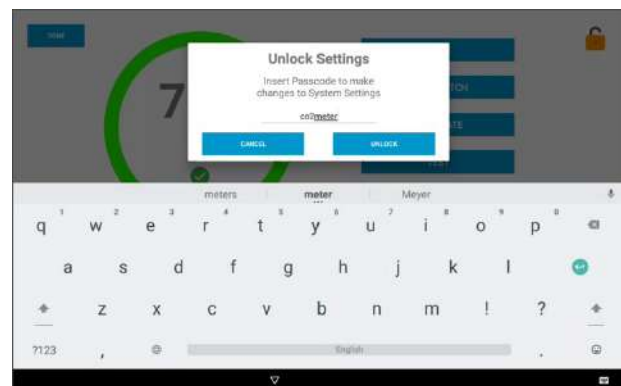
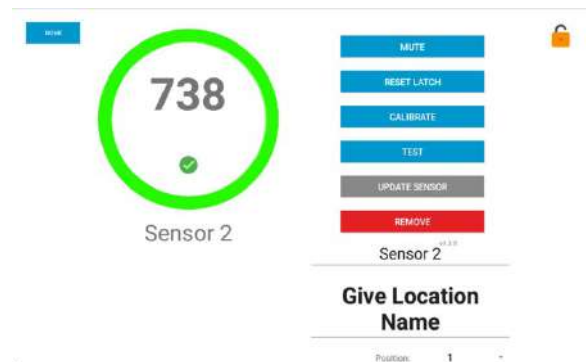
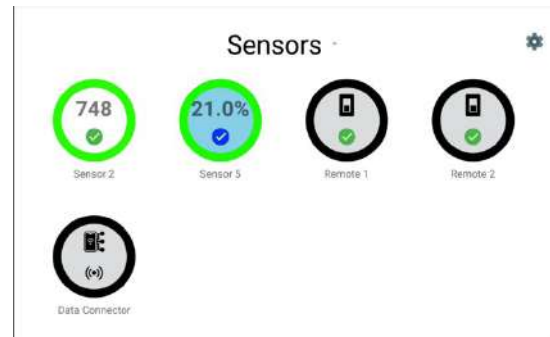

Adjusting Alarm Settings

Step 1: Navigate to Individual Group page, press the gear icon to access that group's Settings Page.

Step 2: Unlock using the password "co2meter"

Step 3: Set the Group Settings to desired configuration.

The user can configure the following settings:

Alarm Level: The CM-7000 CO2 Multi Sensor System features four default alarm levels for CO2

- **Alarm-1 AL1** **5,000ppm TWA**
- **Alarm-2 AL2** **5,000ppm**
- **Alarm-3 AL3** **1.5%**
- **Alarm-4 AL4** **3%**

As well as four default alarm levels for O2

- **Alarm-1 AL1** **20%**
- **Alarm-2 AL2** **19%**
- **Alarm-3 AL3** **17%**
- **Alarm-4 AL4** **15%**

All Alarms are user configurable from the drop-down menu located next to each alarm level value.

Latch- The latch switch will force the alarm to stay on, even if the sensor reads below the alarm trigger level. This functionality was designed specifically for Denver, CO, and requires a reset latch of all sensors that went into alarm before the latch can be cleared.

Sensors - This option allows the user to choose if only the compromised sensor will alarm or if every sensor assigned to that group will alarm.

Mute - The mute setting allows the user to choose whether the sensor mute button deactivates the Strobe, Audio, Both Strobe and Audio, Relays or All.

Mute Time- this setting allows the user to adjust the length of time the mute is in effect.

Volume - this allows the user to adjust the tablet volume (not Horn volume) during alarm status.

Group Sensors- This is a list of sensors and remotes that are connected to that group.

ADD SENSOR OR DEVICE - this button allows the user to add sensors or remotes that have not yet been assigned to a group.

RESET DEFAULT - This button resets Group settings to factory default. This will not reset other groups.

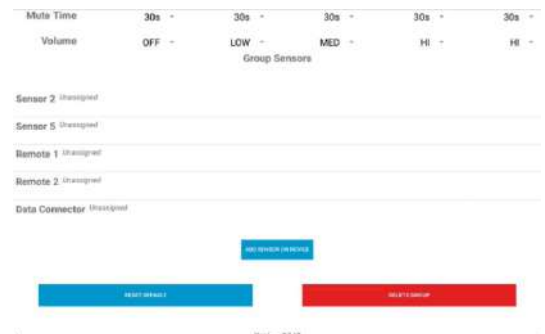
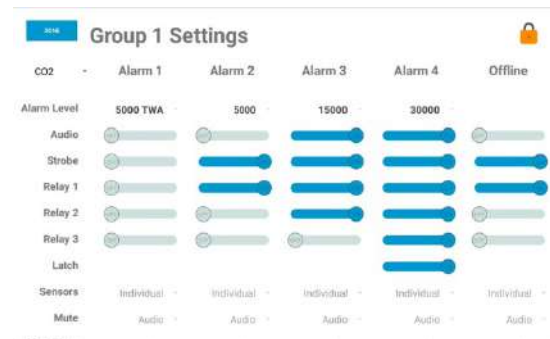

Group Configuration

Creating Group

Once the device is powered on and the CM-7000 app has launched, the user will be able to toggle back and forth from the **Group** and **Sensor** Screen by pressing the drop-down arrow located at the top center of the screen to the left of the screen title.



In order to create a new group, the user must begin on the Main Sensors or Groups screen. Located in the top right hand corner there is a gear settings icon. Press the icon to open the System Settings page displayed below:

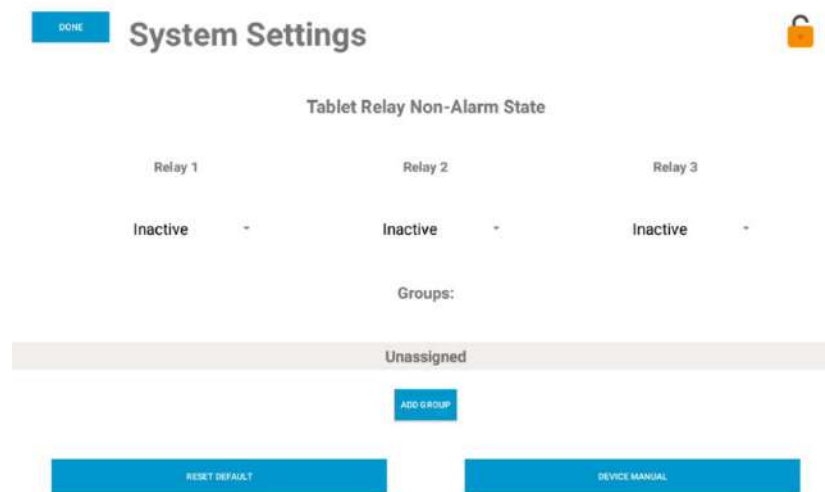

First, begin by unlocking the Group System settings screen. Press the lock icon located in the top right hand corner and enter the password "co2meter". Next, press the **ADD GROUP** button and a prompt will appear that will allow the user to assign a desired name to the group being created. Once named, press the **Done** button located at the top left-hand corner of the systems settings screen to be brought back to the Groups screen. The user can create as many Groups as needed in order to organize the sensors and reset units that are connected to the CM-7000.

*Note: sensors and reset units can only be assigned to one group at a time.

Adding Sensors to a Group

Select the desired group by pressing on that group's icon. The group's screen will appear and look like the screen below:



To add a sensor, first the user must open the Group settings by pressing the icon located in the top right hand corner. Press the icon to open the settings screen displayed below:

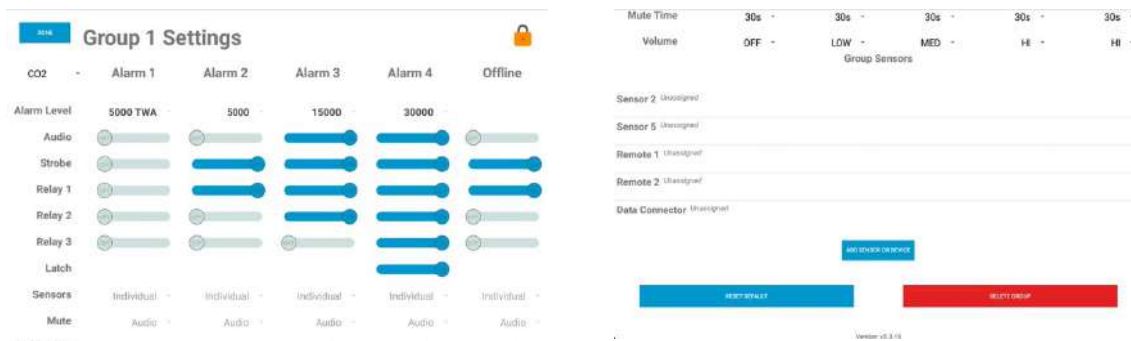

The settings have to be unlocked before changes can be made. Unlock the Group Settings screen by pressing the lock icon located in the top right hand corner and enter the password "co2meter". A list of all available sensors will appear. A Check box will be shown on the screen next to each sensor or reset unit that is connected to the CM-7000. To add a sensor to the group the user should press the check box to select and then press "OK". The sensors will then be added to the Group.

Note: If the sensor has already been assigned to another group, the user will be unable to add that sensor. All sensors that have previously been added to a group will appear faded in this list.



Once the selected sensors are selected and the “OK” button has been pressed the Group screen will appear and display the sensors and remotes that have been selected.



Adjusting Group Settings

To adjust the group settings, the user must select the desired group by touching the screen over that group’s icon. Once the desired Group has been selected the following settings screen will be displayed. The settings must be unlocked prior to adjusting. The password is “co2meter”

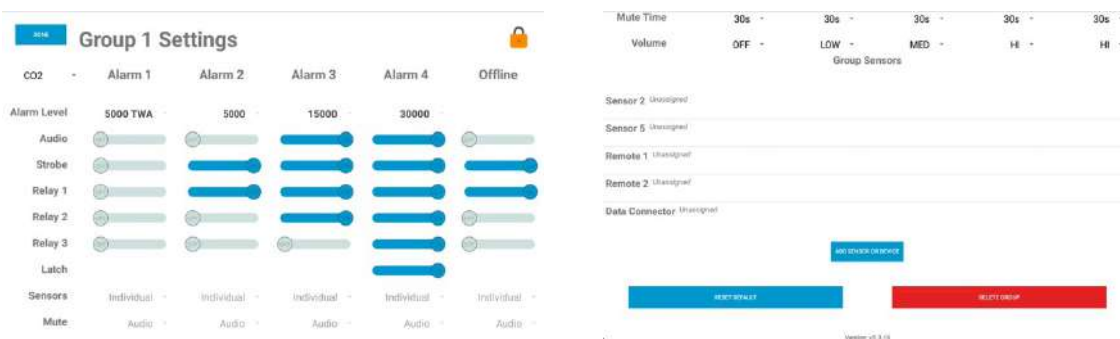

Each group features 4 configurable alarms. The alarm level, audible on/off, Strobe, 3 relays, and latch setting are all configurable. The user can also determine if the alarms are to be triggered individually or if the entire group is to be triggered. Lastly, mute settings and Factory reset can be found on this screen.

Relay Operation and Connection (CM-7005 & CM-7002)

Tablet Relay Operation

- Tablet Relays are triggered by the entire system. Tablet relays mirror the group settings. If relay 1 is triggered by an alarm, any alarm, the tablet relay will be triggered as well.
- The relays that can be set to inactive (normally open) or active (normally closed)
- These settings and feature must be unlocked using the password “co2meter” prior to changing them
- Press done to save configuration

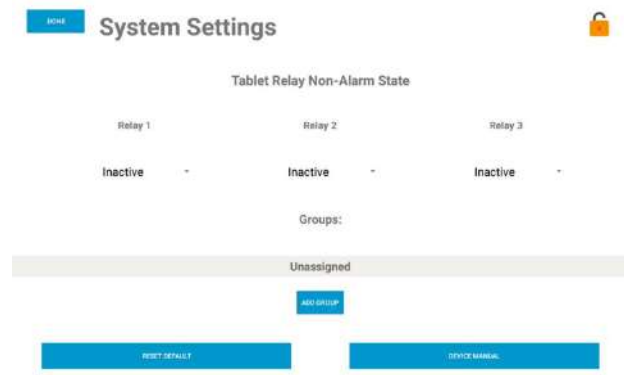

Tablet Relay Connection

The 3 tablet relays are accessible via a screw terminal located on the back of the tablet. A diagram of the back of the tablet can be seen below. Using a screwdriver to securely connect wire leads to appropriate relay connection position.

Back of CM-7005

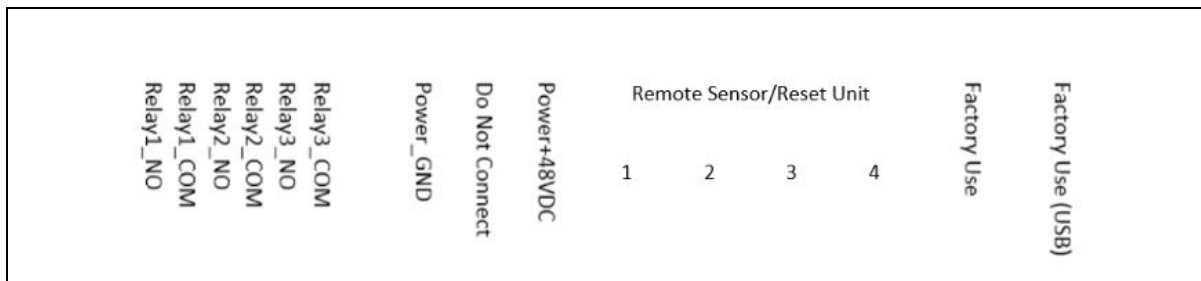

Remote Relay Operation

- Remote Relays are triggered by the alarms associated with the group that remote is assigned to. Relay one is triggered by any alarm level 1 breach in that group. The same is true in that relay 2 is triggered by any alarm 2 breach in that group, and relay 3 to alarm 3.
- The relays that can be set to inactive (normally open) or active (normally closed)
- These settings and features must be unlocked using the password “co2 meter” prior to changing them.
- Press done to save configuration

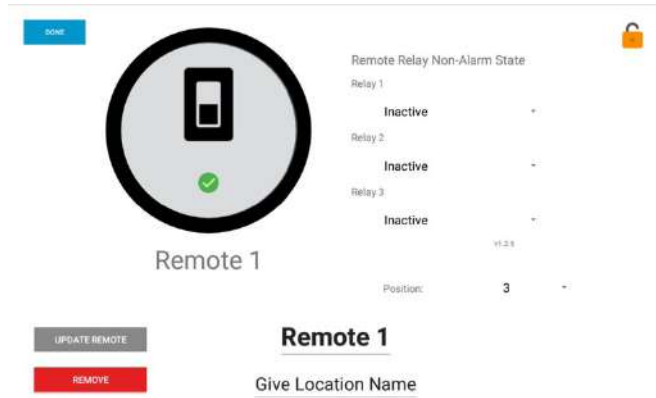

Remote Relay Connection (CBL-7002)

Remote Relay Access is easiest achieved by utilizing CBL-7002. This cable plugs into the strobe port of the remote as seen below. The cable allows the user to connect to the remote relays via screw terminals. The terminal position can be seen below.

CBL-7002



CBL-7002 CONNECTION TO CM-7002



*** Connect the CBL-7002 to the “Strobe” output on the CM-7002***

TOP VIEW OF SCREW TERMINAL	BOTTOM VIEW OF SCREW TERMINAL
1 + Relay 1_NO	8 - Not Used
2 - Relay 1_COM	7 + Not Used
3 + Relay 2_NO	6 - Relay 3_COM
4 - Relay 2_COM	5 + Relay 3_NO
5 + Relay 3_NO	4 - Relay 2_COM
6 - Relay 3_COM	3 + Relay 2_NO
7 + Not Used	2 - Relay 1_COM
8 - Not Used	1 + Relay 1_NO

RJ45 Pinout T568B

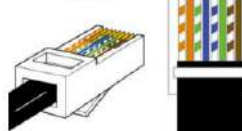

1	Relay-1 COM	White/Orange
2	Relay-1 N/D	Orange
3	Relay-2 COM	White/Green
4	Relay-2 N/D	Blue
5	Relay-3 COM	White/Blue
6	Relay 3 N/D	Green
7	N/C	White/Brown
8	N/C	Brown

Calibration

It is good practice to regularly calibrate the CO2 Sensor. We do so by Zero Calibrating using pure 100% Dry Nitrogen.

The procedure for a CO2 sensor is as follows:

1. On the tablet, tap on the sensor you are calibrating. Tap on the Unlock Button on the top right and enter the password. Scroll to the bottom of the sensor properties screen and tap the "Calibrate" button.
2. Place a flex tube connected to a tank of 99.9% Dry Nitrogen to the sensor orifice on the Remote Sensor Unit
3. When the sensor reads below 300ppm, the calibration will begin and takes 1 minute.
4. Leave the flex tube of Nitrogen on the sensor orifice for the entire minute.
5. When calibration is complete, the Red Alarm LED on the Remote Sensor Unit will flash 5 times, the Strobe may flash as well.
6. Check the tablet for a message validating that the calibration was successful.
7. If the unit fails calibration, it will state fail and you will need to keep the sensor main screen open and troubleshoot, via contacting our support team at either support@CO2Meter.com or speak to an expert, 877-678-4259.

The procedure for a CO2 sensor is as follows:

1. On the tablet, tap on the sensor you are calibrating. Tap on the Unlock Button on the top right and enter the password.
2. Ensure that the area is well ventilated with conditions like that of ambient outdoor air.
3. Scroll to the bottom of the sensor properties screen and tap the "Calibrate" button.
4. When calibration is complete, the Red Alarm LED on the Remote Sensor Unit will flash 5 times, the Strobe may flash as well. The sensor unit should now read 20.9% - 21.0%
5. Check the tablet for a message validating that the calibration was successful.
6. If the unit fails calibration, it will state fail and you will need to keep the sensor main screen open and troubleshoot, via contacting our support team at either support@CO2Meter.com or speak to an expert, 877-678-4259.

Please note: The end user has a choice of either calibrating themselves with a tank of nitrogen or sending it back to CO2Meter to calibrate for a small calibration fee.

Safety Notice

Warning: Your safety is very important to us. To ensure the proper and safe use of the device, please read all warnings and the entire User Manual before using the device. Otherwise, the protection provided by the equipment may be impaired. These warnings provide important safety information and should always be observed.

1. Please handle the device carefully. Do not subject the product to impact or shock, as it could lead to sensor accuracy drift.
2. Do not place the unit near a heat source. Heat may distort the unit.
3. Do not touch the exposed electronic circuitry of the device under any circumstances, as there is danger of electric shocks. All relays are dry contact and can remain exposed without risk of electric shock.
4. Please take care of the cable connection between Sensor Unit and Main Tablet. Make sure the cable from Sensor Unit Output (Main Tablet) port is connected to the Main Tablet INPUT (Sensor Unit/Main Tablet) port.
5. The dry contact relays do not provide power to external devices, like ventilation fans. If there is no power supply to the fan, the relay will not work. This may result in potential danger with high CO₂ concentration in confined space.
6. 6 bilingual Warning Signs are included with each device.

Product Care

To ensure maximum benefit from this product, please observe the follow guidelines.

1. Repair - Do Not attempt to repair or modify the device in any way. Please contact CO₂Meter directly if the product needs servicing, including replacement or calibration service. See Section 15 for technical support contact information.
2. Cleaning - Disconnect the power before cleaning. Use a damp cloth. Do not use liquid cleaning agents such as benzene, thinner or aerosols, as these will damage the device. Do Not splash the unit with water.
3. Maintenance – We recommend users to test the communication between the Sensor Unit and Main Tablet. This can be done by toggling the Test button on the Sensor Detail Page and checking that the CO₂ values occasionally change.

Support

Contact us: We're here to help!

If the troubleshooting guide above doesn't help you solving your problem or for more information, please contact us using the information below.

For further information on the CM-7000, visit our FAQ page: [here](#).



Support@CO2Meter.com



(386) 256-4910 (M-F 9:00am–5:00pm EST)



www.CO2Meter.com

See CO2Meter, Inc. Terms
& Conditions at:

www.CO2Meter.com/pages/terms-conditions



CO2Meter, Inc.

105 Runway Drive

Ormond Beach, FL 32174

Phone: 386-872-7665 | Fax: 866-422-2356

Email: Sales@CO2Meter.com