

Application Note AN-126:

Arduino UART Interface to K-30 Sensor

Introduction

The Arduino Uno, Mega or Mega2560 are ideal microcontrollers for operating SenseAir’s K-30 or K-33 CO2 sensors using an industry-standard UART TXD-RXD connection. Two examples are described:

1. **Basic** - Software.Serial is a library built into the Arduino software that can read CO2 levels only.
2. **kseries.h** - A CO2Meter-developed library which gives greater control of the sensor like calibration. It also allows you to access additional outputs on SenseAir’s K-33 series (ELG, BLG, ICB) of sensors that include temperature and %RH.

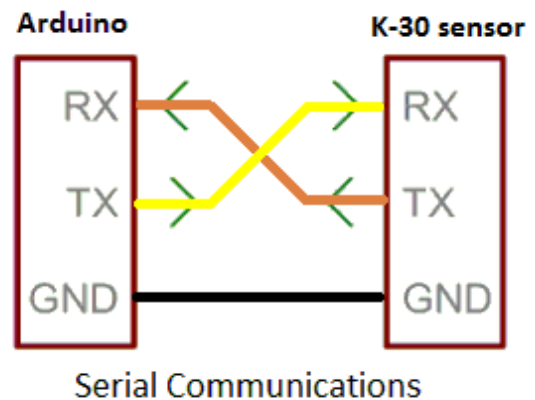

If you are new to Arduino hardware, these low-cost development boards are available from many sources. We recommend you start with authentic Arduino products and the Basic example below.

Run the Blink Example

The best way to become familiar with the Arduino Graphical User’s Interface (GUI) is to verify your Arduino board is operating properly. Create an Arduino project and run the example **Blink**. This simple test program confirms that a number of connection details and that the GUI are working properly.

Caution: Do not connect the Arduino board to the USB port until the Arduino software is installed. Otherwise Windows will install a generic driver and the Arduino will not operate.

Step 1: Install Arduino software on your computer. From this page select the **Windows Installer**.
<https://www.arduino.cc/en/Main/Software>

Step 2: To run the Blink example follow these instructions: <https://www.arduino.cc/en/Tutorial/Blink>

Note that the MEGA Arduinos have a LED on board. The Arduino UNO may require a LED and resistor be added as specified in the tutorial.

Once Blink runs properly, you can connect the K-30 or K-33 sensor.

Connecting the K30 Sensor

Refer to the wiring diagram below for the Arduino Uno or Arduino Mega 2560. The connections for Arduino MEGA are identical to the Mega2560.

Important: A 6-9 VDC, 500 ma or greater, external power supply is highly recommended since the K-30 draws 300+ma when sampling. Connect the power supply as shown.

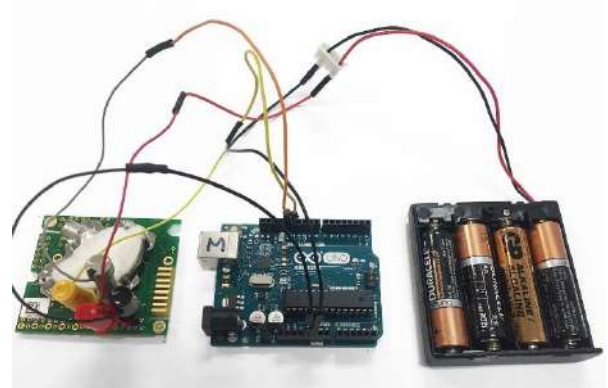

Arduino UNO to K-30 via Software.serial UART

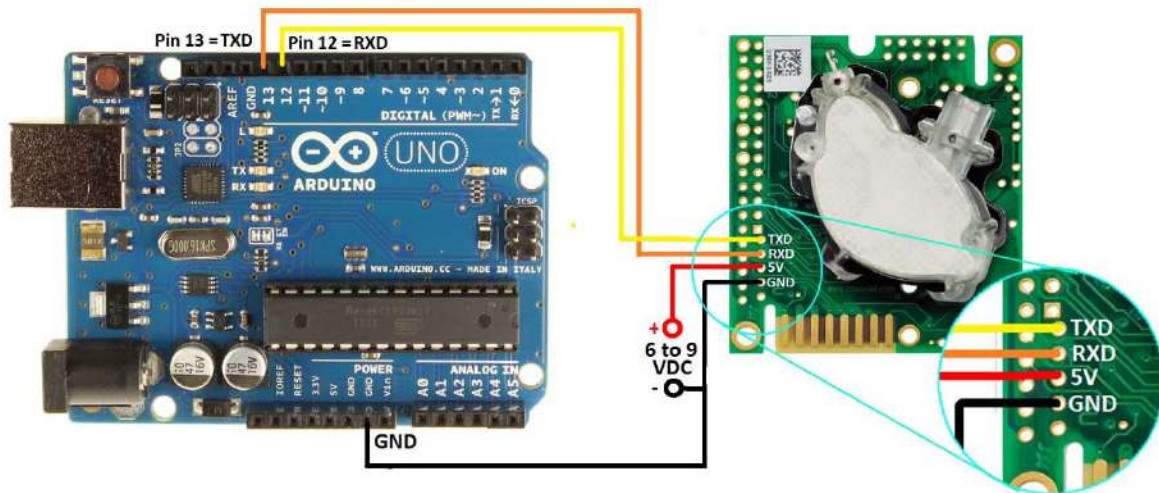

Arduino MEGA or MEGA 2560 TO K-30 via Software.serial UART

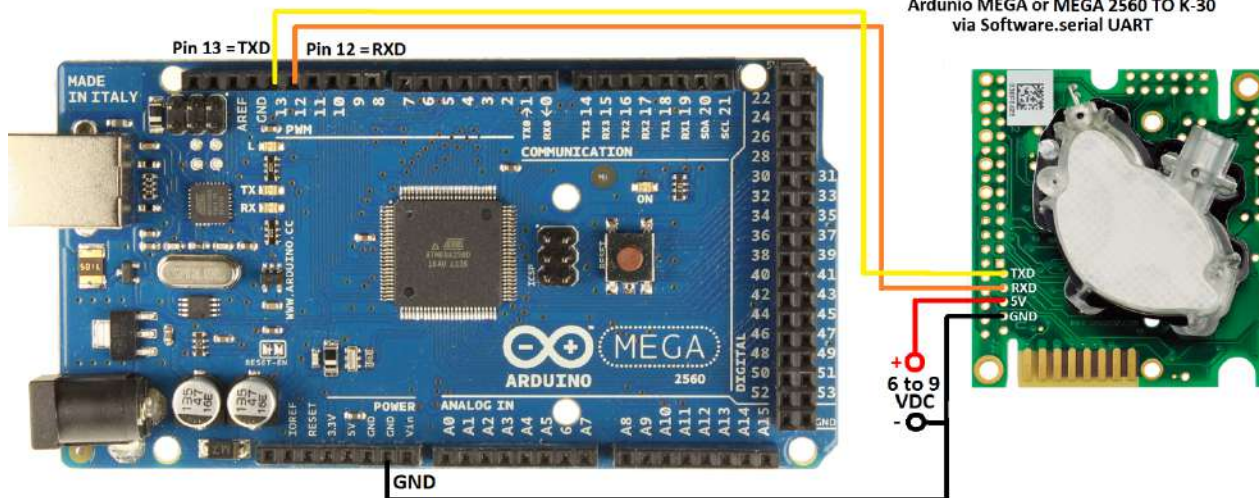

Creating an Arduino Project

Example 1: Basic

This example uses the SoftwareSerial driver which is built into the Arduino software. This statement

```
SoftwareSerial K_30_Serial(12,13)
```

Sets up a virtual serial port using pin 12 for Rx and pin 13 for Tx on both the UNO and MEGA boards.

Demo file download instructions

1. Click on the following link or copy this URL to download the example code:

www.co2meters.com/Documentation/AppNotes/AN126-K3x-sensor-arduino-uart.zip

2. Save the example code to your hard drive. Inside the .zip file, navigate to the K30_basic.ino file in the example folder. Extract it from the .zip file.

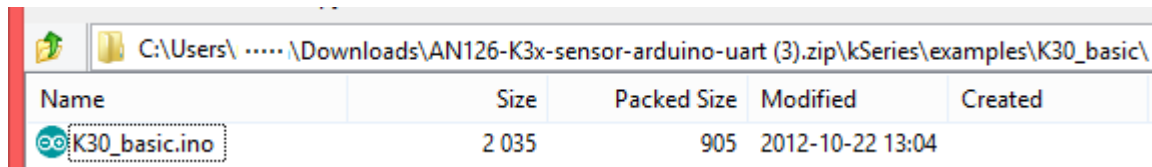

3. Double-click the K30_basic.ino file to open it in the Arduino GUI. It will start and ask the following:

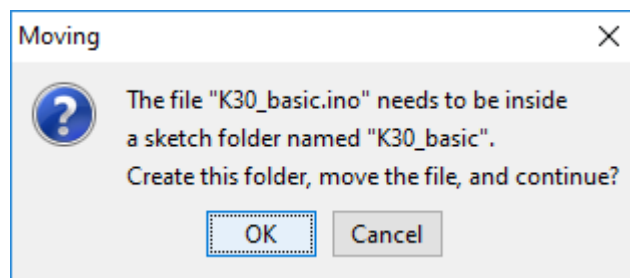

4. Click on OK. Observe the Arduino project code is displayed.

5. Click on Sketch >> Verify/Compile. The project should compile without errors.

6. Verify that your Arduino board is recognized correctly:

a. Click on Tools. Set Board to Arduino Uno or MEGA.

b. Confirm that Processor matches your Arduino: Uno, MEGA or MEGA 2560.

7. Click on Upload. When done uploading, your project is now running in the Arduino board.

8. To view program operation, click on Tools >> Serial Monitor.

9. Observe the following:

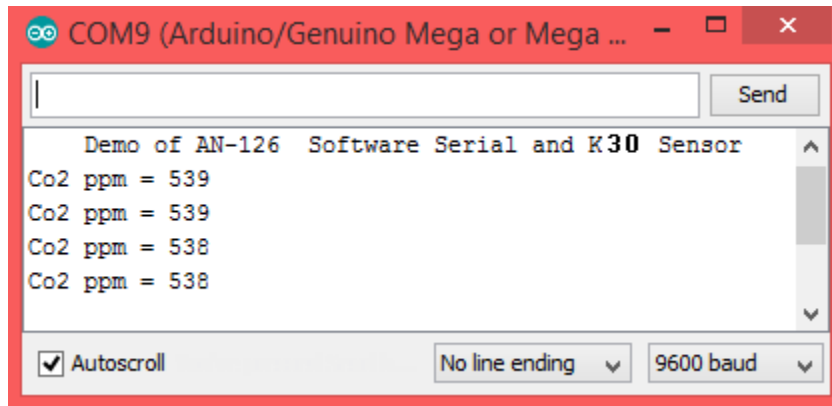

Note Appendix A contains the .txt version of Arduino code. It is also available in the AN126-K3x-sensor-arduino-uart.zip file.

Example 2: kseries.h

CO2Meter has written the kseries.h library to enable additional features beyond simply reading the current CO2 levels from the K-30 and K-33 series sensors. This library includes useful functions such as

- `getCO2(char format)`
- `getTemp()`, `getRH()`
- `chkSensorType()`, `chkK33()`, `chkASCII()`

Note that not all sensor functionality is implemented in this library. It is only used as an example of the most common functions. However, using this model, you can easily discover how to implement additional functions specific to each sensor by referring to the particular sensor's documentation on the CO2Meter.com website.

Installing the Arduino library

Like other Arduino libraries, this one is distributed as a folder in a .ZIP file. The name of the folder Kseries folder is the name of the library. Inside the folder will be .cpp (C++) files, .h file files, a keywords.txt file, and examples in the \example folder. Starting with Arduino version 1.0.5, this allows you to install our libraries in the IDE.

1. Click on the following link or copy this URL to download the example code:

www.co2meters.com/Documentation/AppNotes/AN126-K3x-sensor-arduino-uart.zip

Do not unzip the downloaded library, leave it as is.

2. Open the Arduino IDE, navigate to *Sketch > Include Library*. At the top of the drop down list, select the option to "Add .ZIP Library".

3. Navigate to your Download directory and click on the AN126-K3x-sensor-arduino-uart.zip file. The IDE will install the .h files, the .ccp files and additional necessary files.

4. From the zip file's \examples\K30_example_2 folder, double-click K30example_2.ino to open it in the Arduino GUI.

5. The GUI will ask you to create a project folder. Click OK. Observe the Arduino project code is displayed.

6. Click on Sketch >> Verify/Compile. The project should compile without errors.

7. Verify that your Arduino board is recognized correctly:

1. Click on Tools. Set Board to Arduino Uno or MEGA.
2. Confirm that Processor matches your Arduino: Uno, MEGA or MEGA 2560.

8. Click on Upload. When done uploading, your project is now running in the Arduino board.

9. To view program operation, click on Tools >> Serial Monitor. Observe the output as follows:

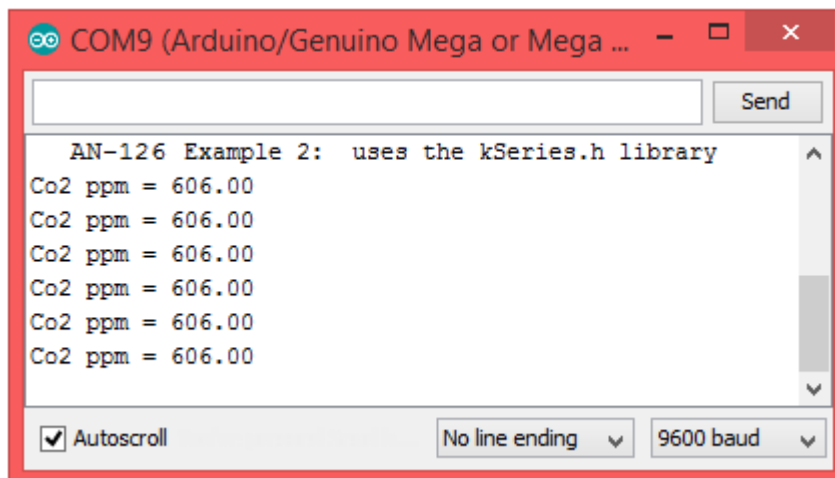

Appendix: Example 1

K30_basic.ino

```
// AN-126 Demo of K-30 using Software Serial
#include <SoftwareSerial.h>
/*
  Basic Arduino example for K-Series sensor
  Created by Jason Berger
  Co2meter.com
*/
#include "SoftwareSerial.h"
SoftwareSerial K_30_Serial(12,13); //Sets up a virtual serial port
  //Using pin 12 for Rx and pin 13 for Tx
byte readCO2[] = {0xFE, 0X44, 0X00, 0X08, 0X02, 0X9F, 0X25}; //Command
packet to read Co2 (see app note)
byte response[] = {0,0,0,0,0,0,0}; //create an array to store the response
//multiplier for value. default is 1. set to 3 for K-30 3% and 10 for K-33
ICB
int valMultiplier = 1;

void setup()
{
  // put your setup code here, to run once:
  Serial.begin(9600); //Opens the main serial port to communicate with the
computer
  K_30_Serial.begin(9600); //Opens the virtual serial port with a baud of
9600
  Serial.println("    Demo of AN-126  Software Serial and K-40 Sensor");
}

void loop()
{
  sendRequest(readCO2);
  unsigned long valCO2 = getValue(response);
  Serial.print("Co2 ppm = ");
  Serial.println(valCO2);
  delay(2000);
}
void sendRequest(byte packet[])
{
  while(!K_30_Serial.available()) //keep sending request until we start to
get a response
  {
    K_30_Serial.write(readCO2,7);
    delay(50);
  }
}
```

```

}
int timeout=0; //set a timeout counter
while(K_30_Serial.available() < 7 ) //Wait to get a 7 byte response
{
timeout++;
if(timeout > 10) //if it takes too long there was probably an error
{
while(K_30_Serial.available()) //flush whatever we have
K_30_Serial.read();
break; //exit and try again
}
delay(50);
}
for (int i=0; i < 7; i++)
{
response[i] = K_30_Serial.read();
}
}
unsigned long getValue(byte packet[])
{
int high = packet[3]; //high byte for value is 4th byte in packet in the
packet
int low = packet[4]; //low byte for value is 5th byte in the packet
unsigned long val = high*256 + low; //Combine high byte and low byte with
this formula to get value
return val* valMultiplier;
}

```

Appendix: Example 2

K30_example_2.ino

```
/*  AN-126 Example 2 uses kseries.h
  Reports values from a K-series sensor back to the computer
  written by Jason Berger
  Co2Meter.com
*/
#include "kSeries.h" //include kSeries Library
kSeries K_30(12,13); //Initialize a kSeries Sensor with pin 12 as Rx
and 13 as Tx
void setup()
{
  Serial.begin(9600); //start a serial port to communicate with the
computer
  Serial.println("Serial Up!");
}
void loop()
{
  double co2 = K_30.getCO2('p'); //returns co2 value in ppm ('p') or
percent ('%')
  Serial.print("Co2 ppm = ");
  Serial.println(co2); //print value
  delay(1500); //wait 1.5 seconds
}
```