

Freestanding Designer Fireplace

ecosmart⁺
Fire

POP Series



ecosmartfire.com

POP Series Design features



1. Surround Colours

Available in eye-catching orange, yellow, black or white, or request costing for a custom colour (MTO) to suit your personal design style, architectural environment and decor.

Configurations

Available in 4 different heights and two different burner sizes.

Enjoy Indoors & Outdoors

The tray holding the EcoSmart burner has a special plug, which is inserted for use indoors, or removed for outdoor use.

2. Glass Screen Included

The glass screens stabilise the flame in windy conditions and provide an added layer of safety, peace of mind and comfort.

Quick and Easy Installation

With no installation or building works required, simply unpack, put into position, and off you go.

Portable Fireplace

Fully portable, you can move the fireplace between rooms and outdoor spaces, or store away when not needed.

Ground Fixing Brackets

Models come with fixing brackets for permanently locating into a fixed position.

3. Burner Colours

Available with a Stainless Steel or Black Burner.

Environmentally-Friendly

Bioethanol fireplaces use an environmentally-friendly, renewable energy source that burns clean and delivers warming heat. You and your guests will enjoy the ambiance and tranquility of a real fire, without the hassles of burning real wood - no more embers, ash, and soot to clean up.

Global Compliance

These models comply with existing standards in the USA, Europe, UK and Australia. O-TL listed to UL 1370, EN 16647 BSI Certified and ACCC Safety Mandate compliant.

Included Accessories



Jerry Can with Safety Spout & e-NRG bottle adaptor



Lighting Rod & Lighter



Jerry Can Spout Extension

Optional Accessories



Outdoor Covers

*Logs not included







Disclaimer. All product specifications and data are subject to change without notice and believed to be correct at the time of publication. MAD Design Group (MDG), its affiliates, agents, and employees, and all persons acting on its or their behalf (collectively, "MAD Design Group"), disclaim any and all liability for any errors, inaccuracies or incompleteness contained herein or in any other disclosure relating to any product. MDG disclaims any and all liability arising out of the use or application of any product described herein or of any information provided herein to the maximum extent permitted by law. The product specifications do not expand or otherwise modify MDG's terms and conditions of purchase, including but not limited to the warranty expressed therein, which apply to these products. No license, express or implied, by estoppel or otherwise, to any intellectual property rights is granted by this document or by any conduct of MDG. Customers using or selling MDG products not expressly indicated for use in such applications do so entirely at their own risk and agree to fully indemnify MDG for any damages arising or resulting from such use or sale. Please contact authorised personnel from MDG to obtain written terms and conditions regarding products designed for such applications. Images are indicative only.

POP 8T Specifications

The tallest of the POP Series, POP 8T is a perfect statement fire for indoor or outdoor settings. Its chic form and array of eye-catching colours provide a big, vibrant impact.

Burner Ventilation and Efficiency*

Dimensions L x W x H mm/in	Compatible Burner	Fuel Capacity	Heats on Average (Indoors)	Thermal Output Net (MAX per burner)	Approx. Burn Time	Minimum Room Size
450 x 450 x 996 17.7 x 17.7 x 39.2	AB8	8 L [2.1 Gals]	Over 60 m ² [645 ft ²]	21.56 MJ/h 20,433 BTU/h, 5.99 kW	7 - 9 hours	116 m ³ [4,096 ft ³]
			Over 30 m ² [322.9 ft ²]	With AB8 Efficiency Ring** (EN Compliant) 13.9 MJ/h 12,860 BTU/h, 3.77 kW	9 - 11 hours	

Application	Indoor & Outdoor	
Surround Colours	 White ESF.D.POP.8.T.WH	 Black ESF.D.POP.8.T.BL
	 Orange ESF.D.POP.8.T.OR	 Yellow ESF.D.POP.8.T.YL
Burner Colours	 Stainless Steel	 Black
Materials	Grade 202 Stainless Steel surround with Coloured Powder-coating, Grade 304 Stainless Steel Burner with optional Black Ceramic Coating, Borosilicate Glass Fire Screen	
Approx. Weight	27.6kg [60.7lbs] Weight includes burner.	
Fuel Type	e-NRG Bioethanol / e-NRG.com	

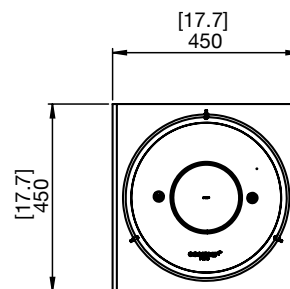
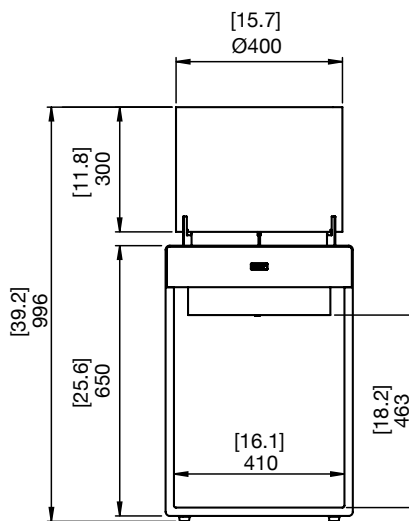

*These values are indicative only and may vary depending on the model purchased, installation, and the seasonal resource used to manufacture e-NRG.
This model comes with fixing brackets for permanently locating into a fixed position.
This model complies with existing standards in the USA, Europe, UK and Australia. O-TL listed to UL 1370, EN 16647 BSI Certified and ACCC Safety Mandate compliant.

FOR MORE INFORMATION PLEASE REFERENCE THE CLEARANCE & INSTALLATION MANUAL

Disclaimer: All product specifications and data are subject to change without notice and believed to be correct at the time of publication. MAD Design Group (MDG), its affiliates, agents, and employees, and all persons acting on its or their behalf (collectively, "MAD Design Group"), disclaim any and all liability for any errors, inaccuracies or incompleteness contained herein or in any other disclosure relating to any product. MDG disclaims any and all liability arising out of the use or application of any product described herein or of any information provided herein to the maximum extent permitted by law. The product specifications do not expand or otherwise modify MDG's terms and conditions of purchase, including but not limited to the warranty expressed therein, which apply to these products. No license, express or implied, by estoppel or otherwise, to any intellectual property rights is granted by this document or by any conduct of MDG. Customers using or selling MDG products not expressly indicated for use in such applications do so entirely at their own risk and agree to fully indemnify MDG for any damages arising or resulting from such use or sale. Please contact authorised personnel from MDG to obtain written terms and conditions regarding products designed for such applications. Images are indicative only.







POP 8L Specifications

A low-set modern retro style piece of fire furniture, the POP 8L is a combination of contemporary influences and nostalgic design elements.

Burner Ventilation and Efficiency*

Dimensions L x W x H mm/in	Compatible Burner	Fuel Capacity	Heats on Average (Indoors)	Thermal Output Net (MAX per burner)	Approx. Burn Time	Minimum Room Size
450 x 450 x 796 17.7 x 17.7 x 31.3	AB8	8 L [2.1 Gals]	Over 60 m ² [645 ft ²]	21.56 MJ/h 20,433 BTU/h, 5.99 kW	7 - 9 hours	116 m ³ [4,096 ft ³]
			Over 30 m ² [322.9 ft ²]	13.9 MJ/h 12,860 BTU/h, 3.77 kW	9 - 11 hours	

With AB8 Efficiency Ring (EN Compliant)**

Application	Indoor & Outdoor
Surround Colours	<div style="display: flex; justify-content: space-around;"> <div style="text-align: center;">  White ESF.D.POP.8.L.WH </div> <div style="text-align: center;">  Black ESF.D.POP.8.L.BL </div> </div> <div style="display: flex; justify-content: space-around; margin-top: 10px;"> <div style="text-align: center;">  Orange ESF.D.POP.8.L.OR </div> <div style="text-align: center;">  Yellow ESF.D.POP.8.L.YL </div> </div>
Burner Colours	<div style="display: flex; justify-content: space-around;"> <div style="text-align: center;">  Stainless Steel </div> <div style="text-align: center;">  Black </div> </div>
Materials	Grade 202 Stainless Steel surround with Coloured Powder-coating, Grade 304 Stainless Steel Burner with optional Black Ceramic Coating, Borosilicate Glass Fire Screen
Approx. Weight	25.1kg [55.2lbs] Weight includes burner.
Fuel Type	e-NRG Bioethanol / e-NRG.com

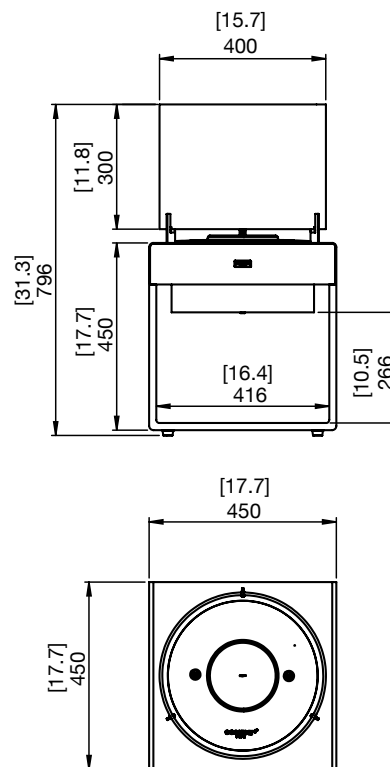

*These values are indicative only and may vary depending on the model purchased, installation, and the seasonal resource used to manufacture e-NRG.
This model comes with fixing brackets for permanently locating into a fixed position.
This model complies with existing standards in the USA, Europe, UK and Australia. O-TL listed to UL 1370, EN 16647 BSI Certified and ACCC Safety Mandate compliant.

FOR MORE INFORMATION PLEASE REFERENCE THE CLEARANCE & INSTALLATION MANUAL







Disclaimer: All product specifications and data are subject to change without notice and believed to be correct at the time of publication. MAD Design Group (MDG), its affiliates, agents, and employees, and all persons acting on its or their behalf (collectively, "MAD Design Group"), disclaim any and all liability for any errors, inaccuracies or incompleteness contained herein or in any other disclosure relating to any product. MDG disclaims any and all liability arising out of the use or application of any product described herein or of any information provided herein to the maximum extent permitted by law. The product specifications do not expand or otherwise modify MDG's terms and conditions of purchase, including but not limited to the warranty expressed therein, which apply to these products. No license, express or implied, by estoppel or otherwise, to any intellectual property rights is granted by this document or by any conduct of MDG. Customers using or selling MDG products not expressly indicated for use in such applications do so entirely at their own risk and agree to fully indemnify MDG for any damages arising or resulting from such use or sale. Please contact authorised personnel from MDG to obtain written terms and conditions regarding products designed for such applications. Images are indicative only.

POP 3T Specifications

An eclectic taller-style portable fire that's full of character, the POP 3T combines modern retro accents with contemporary technology.

Burner Ventilation and Efficiency*

Dimensions L x W x H mm/in	Compatible Burner	Fuel Capacity	Heats on Average (Indoors)	Thermal Output Net (MAX)	Approx. Burn Time	Minimum Room Size
350 x 350 x 851 13.8 x 13.8 x 33.5	AB3	2.5 L [0.7 Gals]	Over 20 m ² [215 ft ²]	6.14 MJ/h 5,800 BTU/h 1.7 kW	8 - 11 hours	40 m ³ [1,413 ft ³]

Application	Indoor & Outdoor
Surround Colours	<div style="display: flex; justify-content: space-around;"> <div style="text-align: center;">  White ESF.D.POP3.T.WH </div> <div style="text-align: center;">  Black ESF.D.POP3.T.BL </div> </div> <div style="display: flex; justify-content: space-around; margin-top: 10px;"> <div style="text-align: center;">  Orange ESF.D.POP3.T.OR </div> <div style="text-align: center;">  Yellow ESF.D.POP3.T.YL </div> </div>
Burner Colours	<div style="display: flex; justify-content: space-around;"> <div style="text-align: center;">  Stainless Steel </div> <div style="text-align: center;">  Black </div> </div>
Materials	Grade 202 Stainless Steel surround with Coloured Powder-coating, Grade 304 Stainless Steel Burner with optional Black Ceramic Coating, Borosilicate Glass Fire Screen
Approx. Weight	16.2kg [35.6lbs] Weight includes burner.
Fuel Type	e-NRG Bioethanol / e-NRG.com

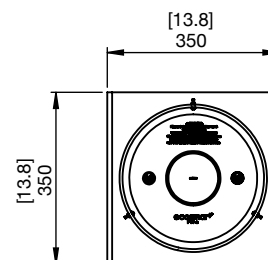
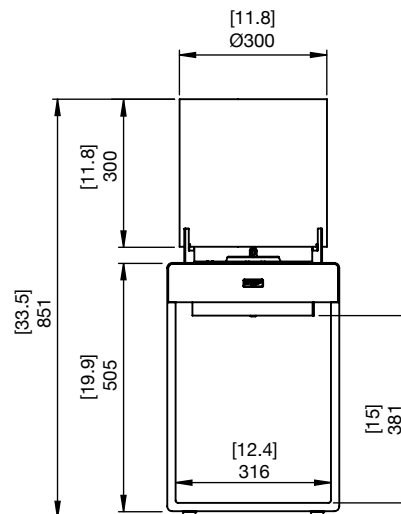

*These values are indicative only and may vary depending on the model purchased, installation, and the seasonal resource used to manufacture e-NRG.
This model comes with fixing brackets for permanently locating into a fixed position.
This model complies with existing standards in the USA, Europe, UK and Australia. O-TL listed to UL 1370, EN 16647 BSI Certified and ACCC Safety Mandate compliant.

FOR MORE INFORMATION PLEASE REFERENCE THE CLEARANCE & INSTALLATION MANUAL







Disclaimer: All product specifications and data are subject to change without notice and believed to be correct at the time of publication. MAD Design Group (MDG), its affiliates, agents, and employees, and all persons acting on its or their behalf (collectively, "MAD Design Group"), disclaim any and all liability for any errors, inaccuracies or incompleteness contained herein or in any other disclosure relating to any product. MDG disclaims any and all liability arising out of the use or application of any product described herein or of any information provided herein to the maximum extent permitted by law. The product specifications do not expand or otherwise modify MDG's terms and conditions of purchase, including but not limited to the warranty expressed therein, which apply to these products. No license, express or implied, by estoppel or otherwise, to any intellectual property rights is granted by this document or by any conduct of MDG. Customers using or selling MDG products not expressly indicated for use in such applications do so entirely at their own risk and agree to fully indemnify MDG for any damages arising or resulting from such use or sale. Please contact authorised personnel from MDG to obtain written terms and conditions regarding products designed for such applications. Images are indicative only.

POP 3L Specifications

Combining chic style and robust construction, the POP 3L is a perfect smaller fire where space is at a premium, whether indoors or out.

Burner Ventilation and Efficiency*

Dimensions L x W x H mm/in	Compatible Burner	Fuel Capacity	Heats on Average (Indoors)	Thermal Output Net (MAX)	Approx. Burn Time	Minimum Room Size
350 x 350 x 696 13.8 x 13.8 x 27.4	AB3	2.5 L [0.7 Gals]	Over 20 m ² [215 ft ²]	6.14 MJ/h 5,800 BTU/h 1.7 kW	8 - 11 hours	40 m ³ [1,413 ft ³]

Application	Indoor & Outdoor
Surround Colours	<div style="display: flex; justify-content: space-around;"> <div style="text-align: center;">  White ESF.D.POP3.L.WH </div> <div style="text-align: center;">  Black ESF.D.POP3.L.BL </div> </div> <div style="display: flex; justify-content: space-around; margin-top: 10px;"> <div style="text-align: center;">  Orange ESF.D.POP3.L.OR </div> <div style="text-align: center;">  Yellow ESF.D.POP3.L.YL </div> </div>
Burner Colours	<div style="display: flex; justify-content: space-around;"> <div style="text-align: center;">  Stainless Steel </div> <div style="text-align: center;">  Black </div> </div>
Materials	Grade 202 Stainless Steel surround with Coloured Powder-coating, Grade 304 Stainless Steel Burner with optional Black Ceramic Coating, Borosilicate Glass Fire Screen
Approx. Weight	15.7kg [34.5lbs] Weight includes burner.
Fuel Type	e-NRG Bioethanol / e-NRG.com

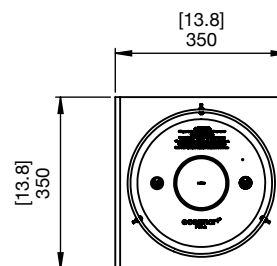
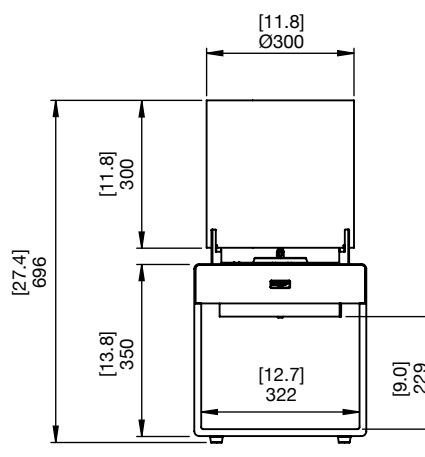

*These values are indicative only and may vary depending on the model purchased, installation, and the seasonal resource used to manufacture e-NRG.
 This model comes with fixing brackets for permanently locating into a fixed position.
 This model complies with existing standards in the USA, Europe, UK and Australia. O-TL listed to UL 1370, EN 16647 BSI Certified and ACCC Safety Mandate compliant.

FOR MORE INFORMATION PLEASE REFERENCE THE CLEARANCE & INSTALLATION MANUAL

Disclaimer: All product specifications and data are subject to change without notice and believed to be correct at the time of publication. MAD Design Group (MDG), its affiliates, agents, and employees, and all persons acting on its or their behalf (collectively, "MAD Design Group"), disclaim any and all liability for any errors, inaccuracies or incompleteness contained herein or in any other disclosure relating to any product. MDG disclaims any and all liability arising out of the use or application of any product described herein or of any information provided herein to the maximum extent permitted by law. The product specifications do not expand or otherwise modify MDG's terms and conditions of purchase, including but not limited to the warranty expressed therein, which apply to these products. No license, express or implied, by estoppel or otherwise, to any intellectual property rights is granted by this document or by any conduct of MDG. Customers using or selling MDG products not expressly indicated for use in such applications do so entirely at their own risk and agree to fully indemnify MDG for any damages arising or resulting from such use or sale. Please contact authorised personnel from MDG to obtain written terms and conditions regarding products designed for such applications. Images are indicative only.