

# CONNECT

MODULAR  
SOFAS





L50 Left  
(Flanelle)



R50 Right  
(Flanelle)

BLINDE'S CONNECT MODULES OFFER THE FREEDOM OF CREATING A LOUNGE IN THE SIZE AND SHAPE YOU DESIRE WITH THE ADDED CONVENIENCE OF CLICKING THEM TOGETHER TO KEEP IT IN PLACE.

CONNECT HAS ENDURING STYLE TOO, WITH A TIMELESS LOW-BACK DESIGN, GENTLE CURVES, STRONG COATED ALUMINIUM FRAME AND QUICK DRY FOAM COVERED IN WEATHER-RESISTANT SUNBRELLA® FABRIC IN NATURAL HUES. OPTIONAL CUSHIONS, ALSO IN SUNBRELLA® FABRIC, ARE AVAILABLE TO COMPLETE YOUR LOOK.

## CONNECT

### Materials

Coated aluminium frame, Quick dry foam, Sunbrella® Fabric

### Cushions (Sold Separately)

500mm [20"] x 500mm [20"]  
650mm [25"] x 650mm [25"]

### Sunbrella® Fabric Colours

Flanelle, Sooty, Canvas



### L50 Left

BLD.1.MS.CON.L50

### R50 Right

BLD.1.MS.CON.R50

### Weight

Approx 14kg / 30.9lbs

### Dimensions

L 1267mm [49.9"]  
W 950mm [37.4"]  
H 780mm [30.7"]  
SH 420mm [16.5"]

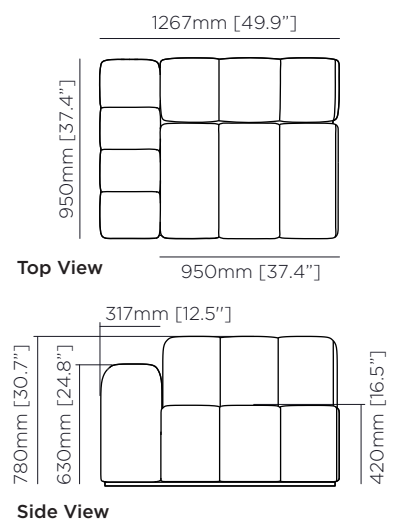



C37 Corner  
(Flanelle)



S37 Single  
(Flanelle)



O37 Ottoman  
(Flanelle)

**C37** Corner  
BLD.1.MS.CON.C37

**Weight**  
Approx 12.6kg / 27.7lbs

**Dimensions**  
L 950mm [37.4"]  
W 950mm [37.4"]  
H 780mm [30.7"]  
SH 420mm [16.5"]

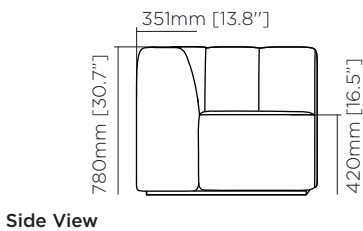
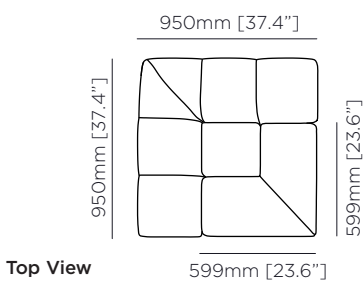

**S37** Single  
BLD.1.MS.CON.S37

**Weight**  
Approx 11.6kg / 25.5lbs

**Dimensions**  
L 950mm [37.4"]  
W 950mm [37.4"]  
H 780mm [30.7"]  
SH 420mm [16.5"]

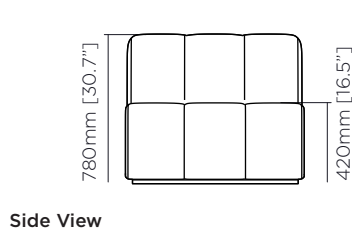
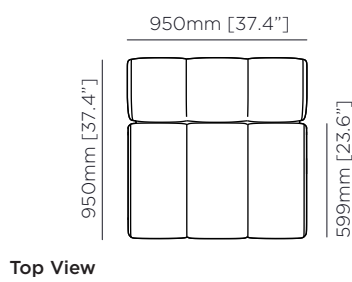

**O37** Ottoman  
BLD.1.MS.CON.O37

**Weight**  
Approx 8kg / 17.6lbs

**Dimensions**  
L 950mm [37.4"]  
W 950mm [37.4"]  
H 420mm [16.5"]

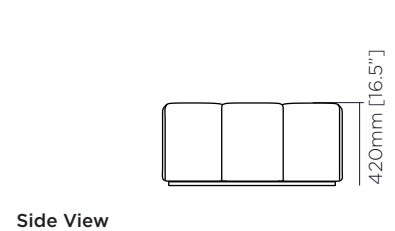
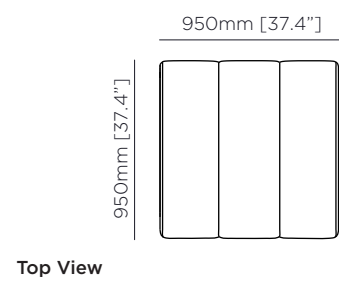

# CONNECT CONFIGURATION PACKAGES

MODULAR  
SOFAS

WITH EIGHT CONFIGURATION PACKAGES TO CHOOSE FROM AND THE OPTION OF CREATING YOUR OWN SHAPE AND SIZE, WITH CONNECT YOU CAN CREATE THE PERFECT MODULAR SOFA, FOR YOUR INDOOR OR OUTDOOR SPACE AND LIFESTYLE. EASY TO MOVE AND CONNECT TOGETHER, YOU CAN ADJUST THE COMBINATION AND CONFIGURATION OF YOUR MODULES FOR EACH OCCASION OR FOR A FRESH NEW LOOK.

**Modular 3 Sofa**  
BLD.MS.CON.S3

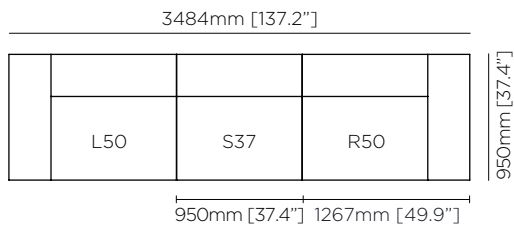

**Modular 4 Sofa**  
BLD.MS.CON.S4

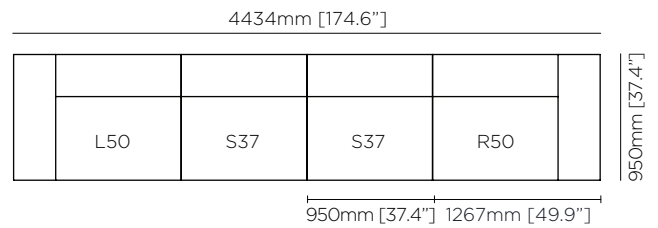

**Modular 5 L-Sectional**  
BLD.MS.CON.LS5

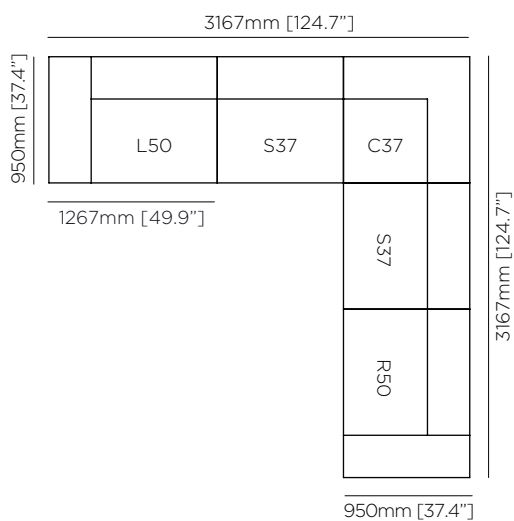

**Modular 5 Sofa Chaise**  
BLD.MS.CON.SC5

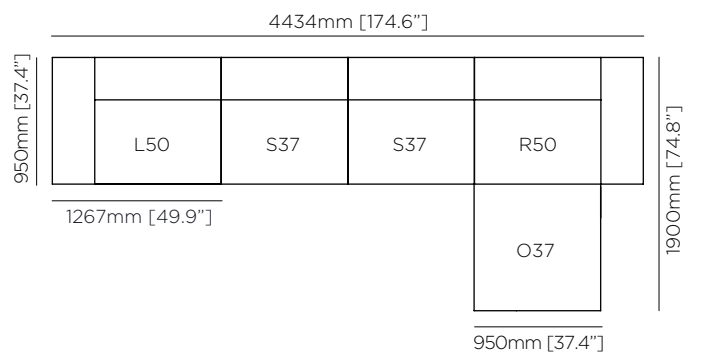

Modular components are available individually, allowing you to customise the configuration of your choice.

# CONNECT CONFIGURATION PACKAGES

MODULAR  
SOFAS

**Modular 6 L-Sectional**  
BLD.MS.CON.LS6

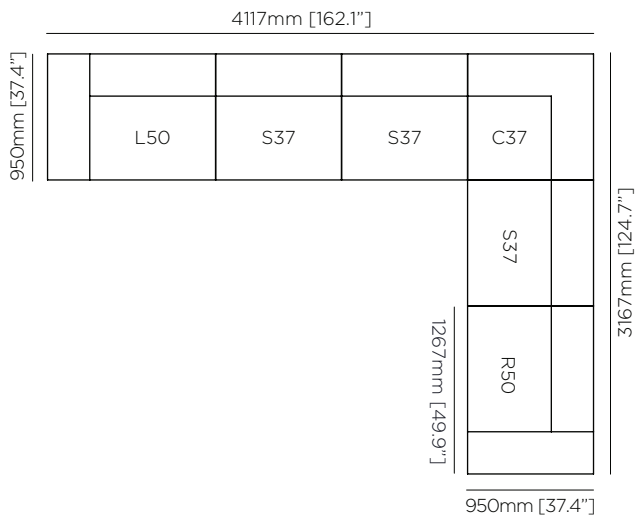

**Modular 6 U-Chaise Sectional**  
BLD.MS.CON.UC6

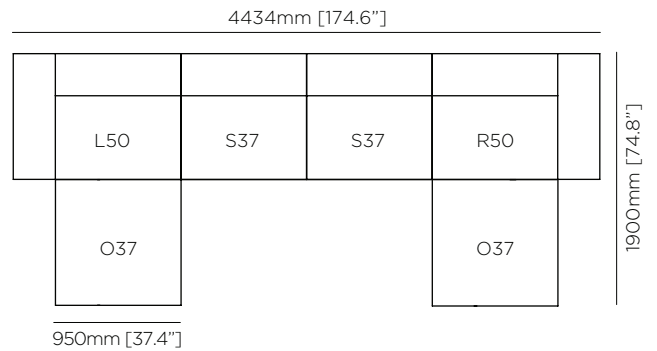

**Modular 7 U-Sofa Chaise Sectional**  
BLD.MS.CON.USC7

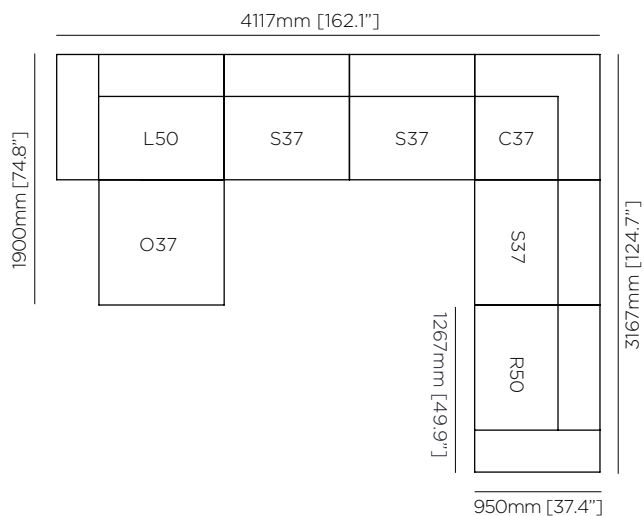

**Modular 8 U-Sofa Sectional**  
BLD.MS.CON.US8

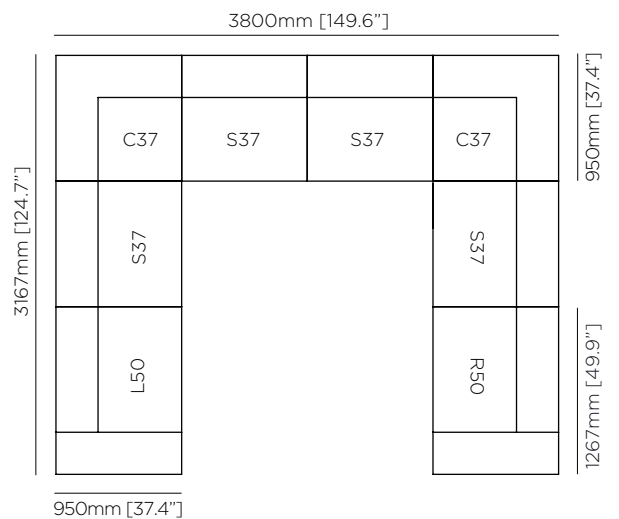

Modular components are available individually, allowing you to customise the configuration of your choice.