

Heli-C-CHECK®

Healthy stomach? Test yourself at home now!
Rapid test for the detection of Helicobacter pylori infection

Früherkennung kann schützen...

Heli-C-CHECK®

Healthy stomach? Test yourself at home now!
Rapid test for the detection of Helicobacter pylori infection

Früherkennung kann schützen...

INSTRUCTIONS FOR USE

INTRODUCTION

The most common cause of painful inflammation of the stomach lining with nausea and abdominal discomfort is a bacterium called Helicobacter pylori. Chronic inflammation in the stomach (gastritis) or ulcer may have further consequences. Moreover, Helicobacter pylori can contribute to the development of diseases, such as ulcers in the stomach and lymphoma progress (a type of cancer).

Heli-C-CHECK® is a rapid test for use at home to detect the presence of Helicobacter pylori antibodies in whole blood. Heli-C-CHECK® is intended as an aid in the diagnosis of Helicobacter pylori infection.

Heli-C-CHECK® as an immunochromatographic rapid test detects the presence of Helicobacter pylori specific anti-IgG antibodies in whole blood. In this test procedure, anti-human IgG is immobilized in the test line region of the test cassette. The sample reacts with Helicobacter pylori antigen coated particles. The mixture migrates chromatographically along the length of the test and interacts with the immobilized anti-human IgG. If the sample contains Helicobacter pylori antibodies, a colored Test line (T) will appear indicating a positive result. The final diagnosis must be confirmed by the physician.

An explanation of how to read and interpret the test result is given in the instruction pamphlet. Therefore, it is important to fully understand the entire instruction pamphlet before performing the test.

Read the instructions for use **completely** before performing the test.

A **step-by-step instruction** is given on the **next page** and describes the test procedure.

TEST CONTENTS

- 1 test cassette in a sealed pouch
 - 1 pipette
 - 1 glass capillary tube in a protective container
 - 1 solution bottle with sample dilution buffer
 - 1 automatic sterile lancet for comfortable blood sampling
- Owen Mumford Ltd.
Brook Hill, Woodstock
Oxfordshire, OX20 1TU, UK
- 1 alcohol pad
 - 1 plaster
 - 1 instruction pamphlet
- Paul Hartmann AG
89522 Heidenheim, Germany

Additionally required:

- 1 timer

TEST PREPARATION

Let test cassette and solution bottle stand at a room temperature (15°C to 27°C) before performing the test. Open the solution bottle with the sample dilution buffer by screwing the cap and let it stand upright on a table.

TEST PERFORMANCE

1. Twist the grey cap on the automatic lancet until cap separates easily from lancet body. Then twist it at least two times again.
2. Slowly massage your fingertip and clean it using the alcohol pad. Wait until the fingertip is dry.
3. Press the automatic lancing device with the round opening firmly against the clean fingertip and activate it by pushing the button. The puncture is almost painless.
4. Open the plastic container and carefully remove the glass capillary tube. Press a drop of blood out of the fingertip. Hold the glass capillary tube horizontally until it has completely filled.
5. Insert the filled glass capillary into the solution bottle and screw the cap back. Mix the content of the solution bottle by turning it gently upside down several times until the blood from the glass capillary tube is mixed with the solution.
6. Before twisting off the cap, let the sample mixture settle back to the bottom of the solution bottle. Only then twist off the cap.
7. Open the sealed pouch and remove the test cassette. Lay it face up on a clean, dry and flat surface.
8. Insert the pipette into the solution bottle and add a few drops of the sample mixture.
9. Hold the pipette with the sample mixture straight up and down over the test cassette and squeeze gently to add exactly 3 drops to the sample well (S). **Please note, that there should be no liquid applied to the result windows marked with the letters (T) and (C).**

Please wait exactly 10 minutes after adding 3 drops to the sample well! Then read the result.

EVALUATION OF TEST RESULTS

To read the test results simply determine whether a line is present or absent at the control (C) position. It does not matter how strong or weak a Control line (C) is.

POSITIVE TEST RESULT

If a **faint red to dark red Control line (C)** is visible in the result window **along with a faint red to dark red Test line (T)**, the test result is positive.

The test result indicates that blood sample contains Helicobacter pylori antibodies, indicating an existing or recent infection with Helicobacter pylori. The diagnosis must be confirmed by the physician.

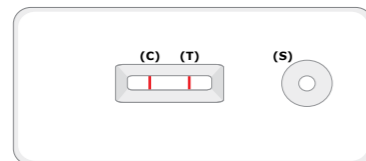

NEGATIVE TEST RESULT

If **only a faint red to dark red Control line (C)** is visible in the result window with **no Test line (T)**, the test result is negative.

The test result indicates that Helicobacter pylori antibodies are not present in the blood sample. Preliminary, there is no existing infection with Helicobacter pylori. If there are any other gastrointestinal symptoms, please, visit the physician for further medical investigation.

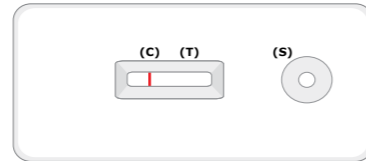

INVALID TEST RESULT

If there is **no Control line (C) or only a Test line (T)** in the result window, the test did not run correctly and the results are not valid.

It is important that you carefully followed the instructions for the test. You should test again with a new blood sample and a new test.

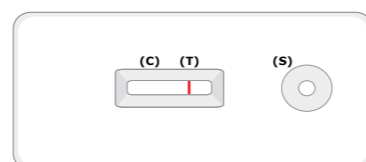
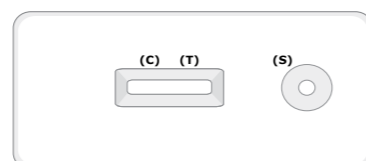

PERFORMANCE EVALUATION

		Reference Test		
Heli-C-CHECK		Positive	Negative	Total
	Positive	63	2	65
	Negative	4	86	90
	Total	67	88	155

Sensitivity: 94,03%
Accuracy: 96,92%

Specificity: 97,73%

WARNINGS AND IMPORTANT INFORMATION

- The test is intended for use outside the body only.
- Not to be taken internally. Avoid sample buffer contact with skin and eyes.
- Keep out of the reach of children.
- Protect from sunlight, do not freeze. Store in a dry place between 10°C und 27°C.
- Do not use after the expiration date printed on the package.
- Not following the exact instructions can affect the outcome of the test. The final diagnosis must be confirmed by the physician.
- Do not use the test if the packaging is damaged. Do not use broken test components.
- All test components are only intended to be used for this test. Do not reuse the test or test components.
- The test should be carried out immediately or within one hour after opening the foil pouch.
- Poor vision, color blindness or poor lighting may affect your ability to interpret the test correctly.
- All test components can be disposed in household waste.

For self-testing

STEP-BY-STEP INSTRUCTION

STEP 1

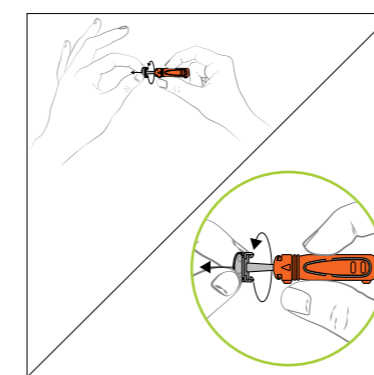

Twist the grey cap on the automatic lancet until cap separates easily from lancet body. Then twist it at least two times again.

STEP 2

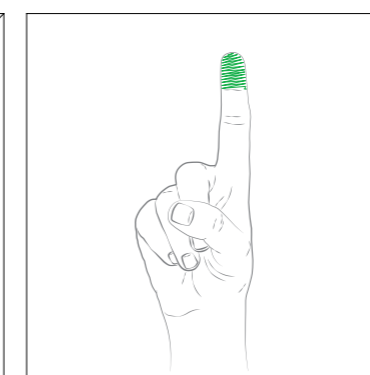

Slowly massage your fingertip and clean it using the alcohol pad. Wait until the fingertip is dry.

STEP 3

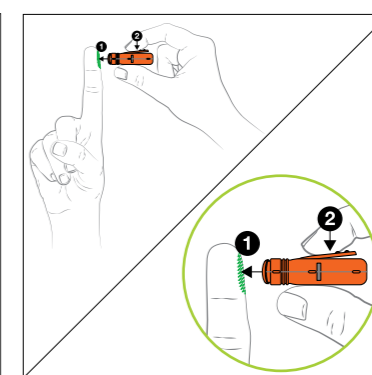

Press the automatic lancing device with the round opening firmly against the clean fingertip 1 and activate it by pushing the button 2. The puncture is almost painless.

STEP 4

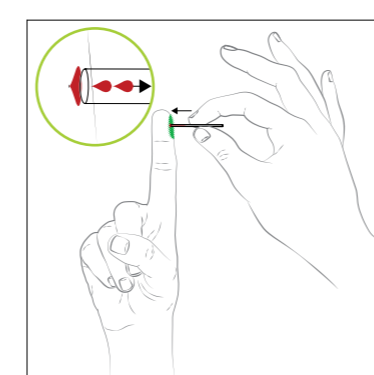

Open the plastic container and carefully remove the glass capillary tube. Press a drop of blood out of the fingertip. Hold the glass capillary tube horizontally until it has completely filled.

STEP 5

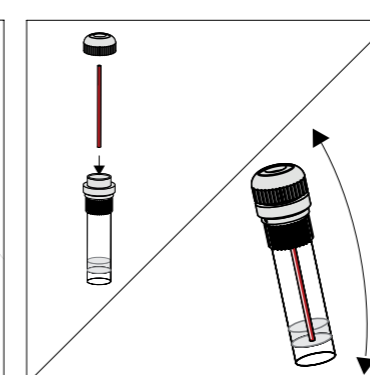

Insert the filled glass capillary into the solution bottle and screw the cap back. Mix the content of the solution bottle by turning it gently upside down several times until the blood from the glass capillary tube is mixed with the solution.

STEP 6

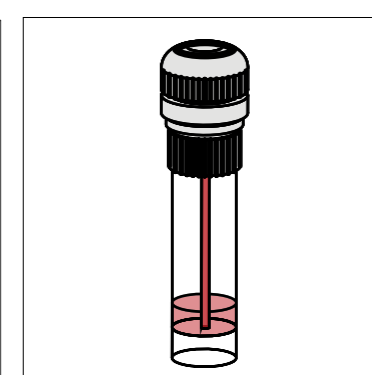

Before twisting off the cap, let the sample mixture settle back to the bottom of the solution bottle. Only then twist off the cap.

STEP 7

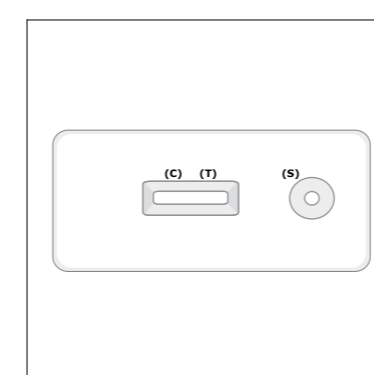

Open the sealed pouch and remove the test cassette. Lay it face up on a clean, dry and flat surface.

STEP 8

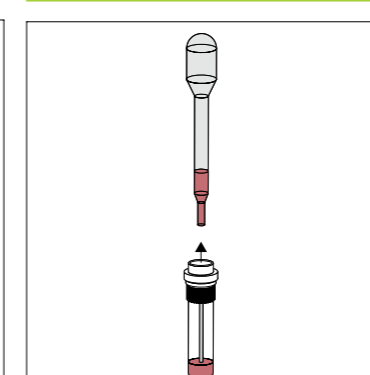

Insert the pipette into the solution bottle and add a few drops of the sample mixture.

STEP 9

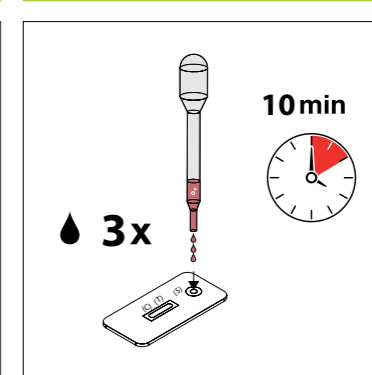

Hold the pipette with the sample mixture straight over the test cassette and squeeze gently to add exactly 3 drops to the sample well (S). Please note that there should be no liquid applied to the result windows marked with the letters (T) and (C). Do not touch or move the test cassette after adding the drops to the sample well (S).

After adding the 3 drops to the sample well, read the result after 10 minutes. After more than 15 minutes false-positive results may occur.

TEST RESULT

POSITIVE TEST RESULT

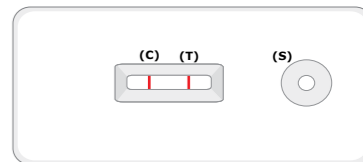

NEGATIVE TEST RESULT

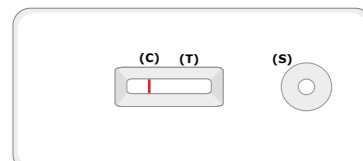

INVALID TEST RESULT

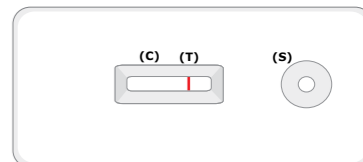
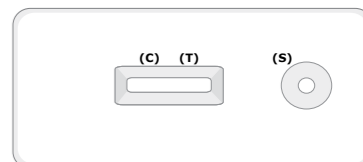

Please give us your feedback on our product by simply filling in the form at the website.

www.zuhausestest.de | www.heliccheck.com

Explanation of symbols:

Follow instructions	In vitro diagnostic medical device (for external use)	Best before (See imprint on package)
Store at 10°C - 27°C Do not freeze.	Content sufficient for 1 test	Do not reuse
Manufacturer	Sterilization by irradiation	Batchnumber (See imprint on package)

CE0483
Instructions English
Revision from 2018-01 (Rev. 01)

NanoRepro AG
Untergasse 8
D-35037 Marburg
www.nanorepro.com

NanoRepro
For the love of life.

www.zuhausestest.de
www.heliccheck.com



For the love of life.