

# TAPELIGHT PROFILES

design by Spazio



## EDGE PROFILE

- Profile for ceiling edge applications
- Extrusion made in anodised aluminium
- Available in 2m lengths
- Diffuser, endcaps and mounting clips are available as accessories
- Requires open or closed LEDtape and accessories (Fig. 1)

## STEP BULLNOSE PROFILE

- Profile for step applications
- Extrusion made in anodised aluminium
- Available in 2m lengths
- Diffuser, endcaps and mounting clips are available as accessories
- Requires open or closed LEDtape and accessories (Fig. 1)

## 50x32 PROFILES

- The extrusion is made in anodised aluminium
- Available in 2m lengths
- Diffuser, endcaps and mounting clips are available as accessories
- Requires open or closed LEDtape and accessories (Fig. 1)

## 35x35 PROFILES

- The extrusion is made in anodised aluminium
- Available in 2m lengths
- Diffuser, endcaps and mounting clips are available as accessories
- Requires open or closed LEDtape and accessories (Fig. 1)

Fig. 1



# TAPELIGHT PROFILES

design by Spazio



## ZERO PROFILES

- The extrusion is made in anodised aluminium
- Available in 2m lengths
- Diffuser, endcaps and mounting clips are available as accessories
- Diffusers Available:
  - Square opal
  - Flat opal
- Requires open or closed LEDtape and accessories (Fig. 1)



## CORNER PROFILE

- Profile for corner applications. Lumen source positioning at 45°
- Extrusion made in anodised aluminium
- Available in 2m lengths
- Diffuser, endcaps and mounting clips are available as accessories
- Diffusers available:
  - Round
  - Square
- Requires open or closed LEDtape and accessories (Fig. 1)



## SLIM PROFILES

- Slimline profile
- Extrusion made in anodised aluminium
- Available in 2m lengths
- Diffuser, endcaps and mounting clips are available as accessories
- Available as a surface or recessed version
- Requires open or closed LEDtape and accessories (Fig. 1)



## PETIT PROFILE

- Thin square profile
- Extrusion made in anodised aluminium
- Available in 2m lengths
- Diffuser, endcaps and mounting clips are available as accessories
- Requires open or closed LEDtape and accessories (Fig. 1)

Fig. 1



# TAPELIGHT PROFILES

design by Spazio



## EDGE PROFILE

To be used with LEDtape + accessories



code  
2m Edge profile  
**1046.05**

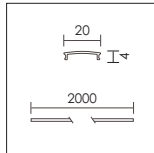
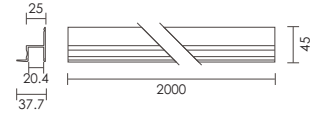

code  
Flat opal diffuser  
**1046.D**

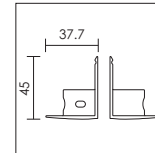

code  
End cap (pair)  
**1046.EC**

## STEP BULLNOSE PROFILE

To be used with LEDtape + accessories



code  
2m Step profile  
**1045.05**

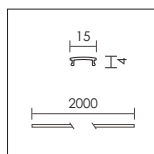
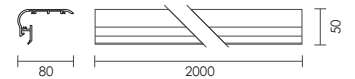

code  
Flat opal diffuser  
**1045.D**

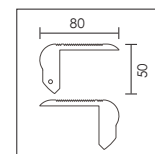

code  
End caps (pair)  
**1045.EC**

# TAPELIGHT PROFILES

design by Spazio



05  
Natural  
Anodised

## 35 x 35 SURFACE

To be used with LEDtape + accessories



code  
2m profile  
**1043.1.05**

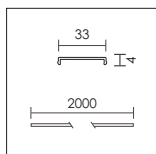
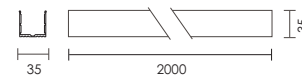

code  
Flat diffuser  
**1043.D**

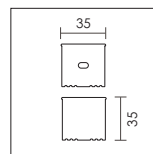
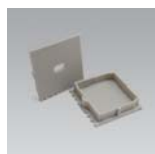

code  
End caps (pair)  
**1043.1.EC**

## 35 x 35 RECESSED

To be used with LEDtape + accessories



code  
2m profile  
**1043.2.05**

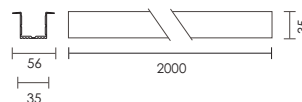

Cut out: 35 x 2000

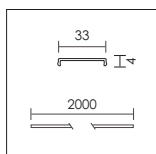

code  
Flat diffuser  
**1043.D**

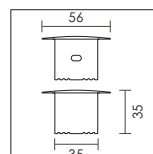
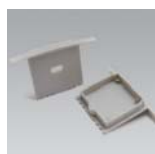

code  
End caps (pair)  
**1043.2.EC**

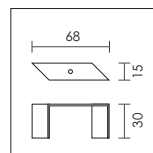

code  
Mounting clip  
**1043.2.MC**

# TAPELIGHT PROFILES

design by Spazio



## 50 x 32 SURFACE

To be used with LEDtape + accessories



code  
2m profile  
**1044.1.05**

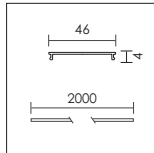
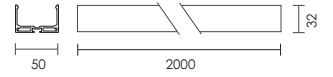

code  
Flat diffuser  
**1044.D**

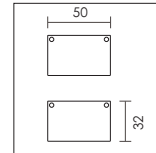

code  
End caps (pair)  
**1044.1.EC**

## 50 x 32 RECESSED

To be used with LEDtape + accessories



code  
2m profile  
**1044.2.05**

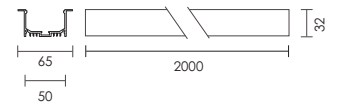

Cut out: 50 x 2000

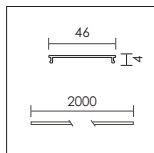

code  
Flat diffuser  
**1044.D**

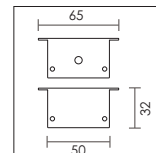

code  
End caps (pair)  
**1044.2.EC**

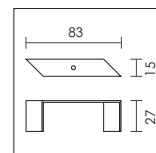

code  
Mounting clip  
**1044.2.MC**

# TAPELIGHT PROFILES

design by Spazio

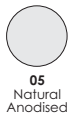

## ZERO SURFACE

To be used with LEDtape + accessories



code  
2m profile  
**1037.1.2000.05**

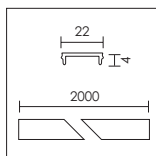

code  
Flat diffuser  
**1037.D.1**

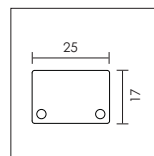

code  
Flat diffuser end cap  
**1037.1.EC.2**

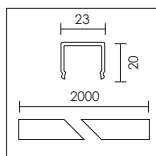

code  
Square diffuser  
**1037.D.2**

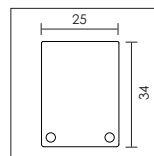

code  
Square diffuser end cap  
**1037.3.EC.2**

## ZERO RECESSED

To be used with LEDtape + accessories

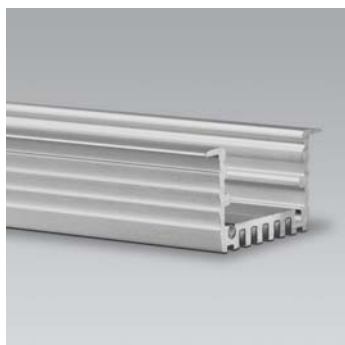

code  
2m profile  
**1037.2.2000.05**

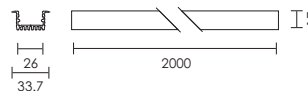

Cut out: 26 x 2000

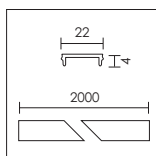

code  
Flat diffuser  
**1037.D.1**

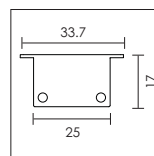

code  
Flat end cap  
**1037.2.EC.2**

# TAPELIGHT PROFILES

design by Spazio



## CORNER PROFILE WITH ROUND DIFFUSER

To be used with LEDtape + accessories



code  
2m profile  
**1040.05**

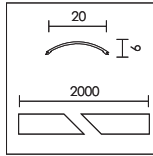
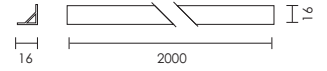

code  
Round diffuser  
**1040.1.D**

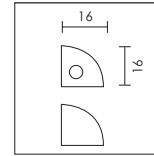

code  
Round end caps (pair)  
**1040.1.EC**

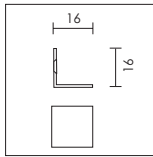

code  
Mounting clip  
**1040.MC**

## CORNER PROFILE WITH SQUARE DIFFUSER

To be used with LEDtape + accessories



code  
2m profile  
**1040.05**

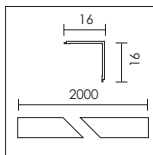
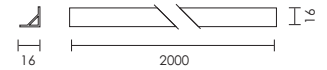

code  
Square diffuser  
**1040.2.D**

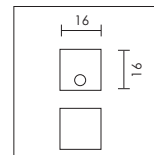

code  
Square end caps (pair)  
**1040.2.EC**

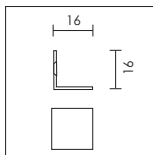

code  
Mounting clip  
**1040.MC**

# TAPELIGHT PROFILES

design by Spazio

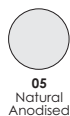

## SLIM SURFACE

To be used with LEDtape + accessories



code  
2m profile  
**1039.1.05**

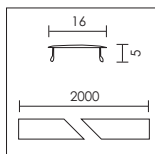
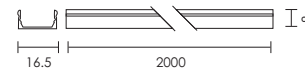

code  
**Slim** profile diffuser 2m  
**1039.D**

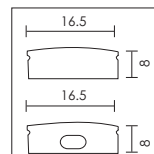

code  
**Slim** surface end cap (pair)  
**1039.1.EC**

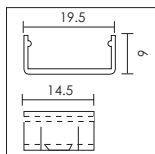

code  
**Slim** surface mounting clip  
**1039.1.MC**

## SLIM RECESSED

To be used with LEDtape + accessories



code  
2m profile  
**1039.2.05**

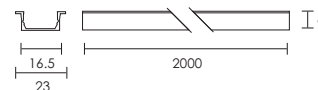

Cut out: 16.5 x 2000

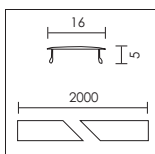

code  
**Slim** profile diffuser 2m  
**1039.D**

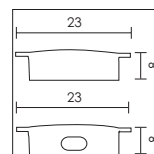

code  
**Slim** recessed end cap (pair)  
**1039.2.EC**



# TAPELIGHT PROFILES

design by Spazio



## PETITE PROFILE

To be used with LEDtape + accessories



code  
2m profile  
**1042.05**

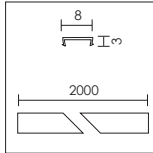
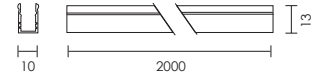

code  
Profile diffuser 2m  
**1042.D**

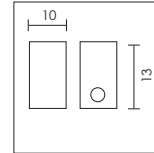

code  
End cap (pair)  
**1042.EC**

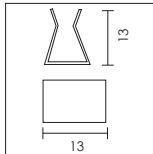
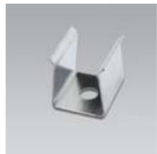

code  
Mounting clip  
**1042.MC**

## BASE 3 HEATSINK



code  
2m aluminium strip  
**1036.10477.2M**

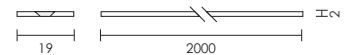

# PROFILE INSTALLATION

design by Spazio



Attach the Zero extrusion to required surface



Remove the application tape from LEDtape and apply to Zero surf.



Applied LEDtape



Attach the desired diffuser, Square or Flat opal diffuser available

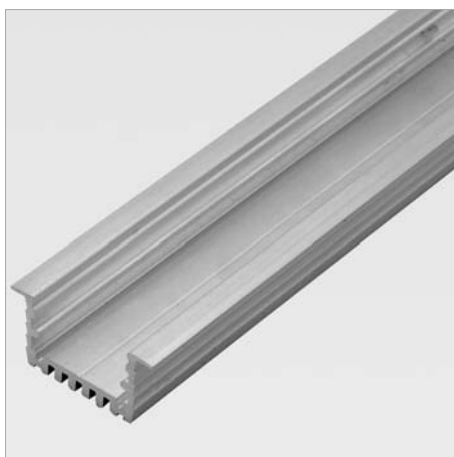

Zero recessed extrusion



Remove the application tape from LEDtape and apply to Zero Rec.



Applied LEDtape



Slide or attach desired diffuser, Square or Flat opal diffuser available

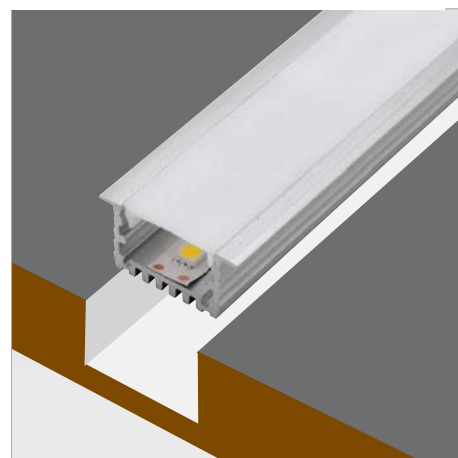

Make the necessary cut out and and install the Zero Recessed