

DUALTRON DUALTRON X II UP

PERSONAL MOBILITY

User Manual



* This product is always two-wheel drive.

Company Introduction

Minimotors Co.LTD., is a company which manufactures and distributes personal mobility with a professional production system since 1999.

Minimotors Co.LTD., created the electric mobility brand 'DUALTRON' to meet the world's needs by making personal mobility more innovative, reliable, and convenient from 1999 to the present and making a product that is loved by people all over the globe. Minimotors Co.LTD., is doing its best to become the world's best electric mobility company.



MINIMOTORS
Co.,Ltd. Since 1999

Brand Introduction

'DUALTRON' brand is a worldwide electric scooter brand name that Minimotors Co.LTD., designed.

'DUALTRON' is a break through product that combines the world's first dual drive system with new rubber suspension technology (patent application). It is a proud Korean luxury brand that has dominated the world's electric scooter market and is currently being exported to more than 30 countries.

DUALTRON®
The dream of electric technology

 **Please read the user manual carefully.**

Do not use the product until you understand its functions.
Do not rent the product to anyone who cannot operate the product.

*For the first time, the user should use it with a slow speed for safety.

01. Safety guidelines and restrictions	04
02. Product structure.....	06
03. Name of each part	07
04. Product components	08
05. How to use the product.....	09
06. How to use the instrument panel	12
07. Product functions guide	15
08. How to use the charger correctly	16
09. Safety precautions for Lithium battery.....	17
10. Safety guidelines before driving.....	18
11. Check and maintenance.....	19
12. Important checklist.....	20
13. Product specifications	22

Before Reading the Manual

This manual contains important information to help you to use your product more safely. For your safety, there are warnings of 'Danger', 'Warning', and 'Caution' depending on the degree of danger and the meanings are below.



Indicates a hazardous situation that will result in serious injury.



Indicates a hazardous situation that could result in serious injury.



Indicates a hazardous situation that could result in minor or moderate injury.

✓ **Please read this manual carefully**
before using this product

1) General safety guidelines and restrictions

* Even if it is within the warranty period, you may be liable for any accident caused by any of the following causes.



1. Be careful of water!

This product and components are not waterproof. Don't let the water get into the product and components.

*Never use it, if the road is wet due to the rain, snow, hailstone.

*If you wash or spread water to electric devices, it can result in malfunction or fire.



2. Beware of folding and spinning parts!

If parts of the body, as a finger or hair, get caught in the spinning or folding parts of the product, this may lead to severe injuries. Please be careful.



3. No acrobatics

Stunts and jumps such as jumping and dropping are prohibited as they can cause a great impact on the product and can cause malfunction and accidents.



4. No companion boarding

This product is intended for one adult only, so children, infants, or two people are prohibited from boarding.



5. Don't tune by yourself

Do not open or tune the electric parts (battery, controller or motor system).



6. No companion boarding

Unlicensed, driving after drinking, loading cargo on the scooter is prohibited. (More than bike or bicycle license is required) Please comply with the Road Traffic Act and related laws and regulations according to the place of use.

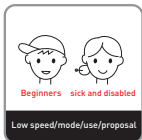

7. Beginners and seniors are encouraged to use at low speed

Beginners who are not accustomed to use the product, seniors and others should avoid high speed mode driving and recommend low speed driving. In addition, please use after practice how to ride safely in a wide place.



8. Do not sudden brake with front brake

If there is a risk of overturning, sudden deceleration should be done safely. Do not apply any unusual behaviors or artificial forces, such as stopping with your feet.

**10. Do not drive on steep slopes**

Acceptable gradeability is different for each product. Excessive hill roads exceeding the specification may cause damage to the product (parts) due to temperature cut, overcurrent, or low voltage cut, which may cause the product to malfunction.

**11. Safety warning when lifting the product**

Please always lift the product with at least one other person. When lifting the product, please be careful not to damage your back or knees.

**12. Be sure to wear safety equipment**

For the safety of passengers, be sure to wear a full face helmet and the other protective gear (for knees, elbows, hands, upper body) and do not wear shoes such as slippers or high heels that can interfere with driving.

2) Precaution before driving

1. Night driving should be avoided at all times. Always wear helmets and other body guards and drive safely.
2. Select the mode that suits you and drive. In order to cope with sudden situations, be prepared to slow down by holding the brake at all times.
3. When turning left / right, slow down to avoid the danger of overturning or slipping, then slowly turn safely.
4. To go backwards safely, get off the product only after coming to a complete stop.
5. It is prohibited to use in any places that are slippery, crowded, have a steep slope, or are uneven.
6. When crossing a pedestrian crossing, get off from the product for pedestrian safety.
7. Do not drive in a way that threatens any other means of transport, such as animals, pedestrians, bicycles, motorcycles, cars, etc.
8. When passing speed bumps and road obstacles, be sure to slow down.
9. When decelerating or braking, do not stop with your foot, but by using the brake appropriately.
10. Be careful as there is a risk of burns due to heat from the motor and brake (especially disk rotor) after driving.
11. It is prohibited to drive by holding the handle with one hand; please use both hands at all times.
12. Do not ride or drive when the kick stand is down.

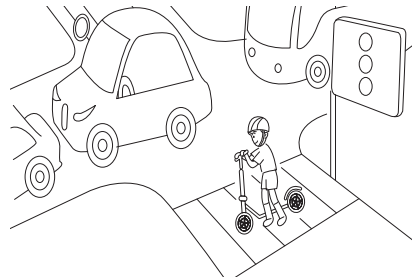

Product structure

Product size

Unfolded



Folded



* Depending on the method of measurement, errors may occur.

Handle

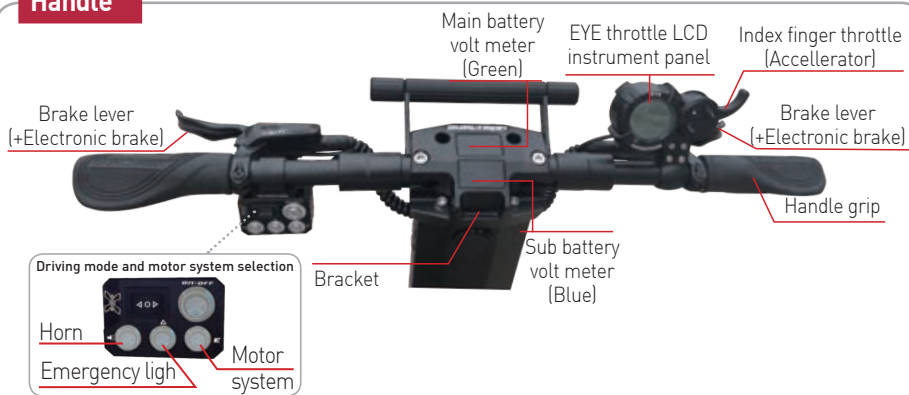

Body frame

Option: Normal post 490mm
Higher post 540mm



Product components

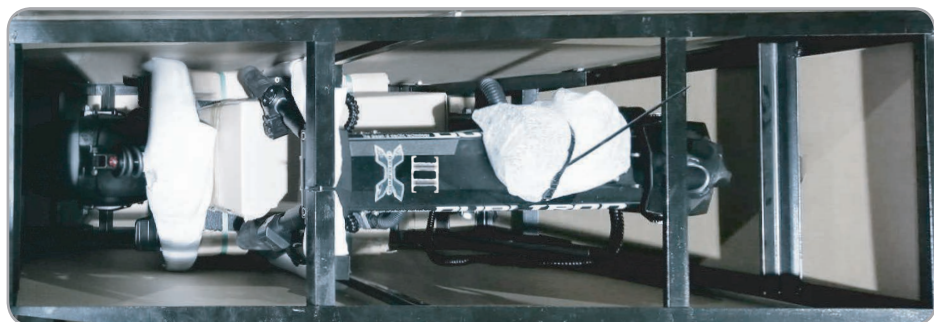

Checking the components inside of the box

Body, Default battery charger 2EA (6.5A, 1.75A), Basic tool, Swing arm fender, User manual

Unboxing the product



This unit is secured to the steel frame in the box. When lifting the product out of the box, make sure that at least two people open it safely, taking into account the weight of the product.

* There is a risk of accident and/or body injury from the folding parts, getting cut by the sharp edges of the steel frame, and by the product falling on the user.

Make a note of the serial number.



The serial number can be used to check information such as date of purchase, warranty period, etc., and product information can be checked even if the product is lost or stolen. (May vary depending on branch office situation.)

Assembling of the instrument panel, brake



-Locate the instrument panel and tighten the fixing bolts.



-Adjust the position of the brake and tighten the fixing bolts with a 4mm hexagon wrench.

1) Product unfolding



1. Raising handle post (Steering tube)

Release the folding knob and push handle post all the way end to raise up.

2. Set up folding part

Lock the folding knob firmly and check for slack or loosening during the drive.

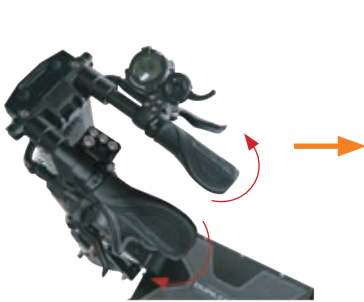

3. Expand handlebar

Push both handlebars out to the end and expand.

4. Length adjustable side stand

The length of the side stand can be adjusted according to the height of the product. Loosen the side stand's length adjustment screw, slide the side stand to the left or right, adjust it to the height of the product, and tighten the length adjustment screw.

Anti-reverse bending screw



Side stand stability check and length adjustment are required for safe positioning of the product.

* Pay attention to loosening and breaking of the anti-reverse bending screws located at the top of the side stand.

CAUTION

How to use the product

2) How to start



Step 1. Turning on the main switch

To turn on the product, press the power button on the instrument panel for 2 seconds to turn on the instrument panel.

You can set the start mode, cruise mode, electronic brakes, and ABS function.

When driving is finished, turn off the LCD panel and turn off the light power.

* The power of the instrument panel will turn off automatically after a few minutes of inactivity.

Step 2. Turning on the LED lights

Pressing the sub-battery power button on the right side of the steering tube will energize the handle.

At this time, when the top of the LED light button is pressed, high power headlights and steering tube lights are illuminated.

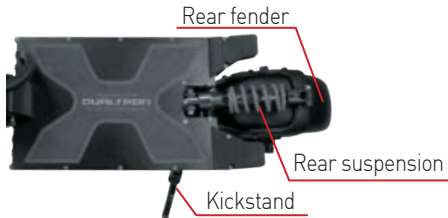

Step 3. Stance for driving

After tilting the kickstand, find a stable position on the footrest and then hold the handle grip comfortably.

Be careful not to raise your foot on the rear fender and rear suspension.

Step 4. Acceleration and deceleration

Acceleration can be performed by using the throttle of the instrument panel while driving, and the deceleration or stop can be performed by holding the brakes on the handle.

Before driving, be sure to check the folding part, the handle part,  CAUTION folding knob, the part where the main fixing part of the product is fastened well.

You must check before board to prevent accidents, check the damage and the position of the suspension fixing bolt which is connecting suspension arm and swing arm.

Throttle malfunction caution

Regardless of whether the throttle is operated or not, the motor sensor may continue to operate, causing malfunctions such as sudden acceleration.

In this case, hold the brake lever to cancel the operation.

This phenomenon may be caused by corrosion of the throttling, immersion of the throttle, disconnection of the magnet, broken off levers, or breakage of the spring.

Do not bounce the throttle lever strongly.

3) How to stop

Step1 Rear brake use

Be sure to use the rear brake first for decelerating when stopping while driving. For a safe stop, it is necessary to practice slowing down after deceleration with rear brake.

Step2 Front brake use

Always use the front and rear brake levers together to stop smoothly and safely after decelerating with the rear brake.



Step3 Driving mode and motor system selection

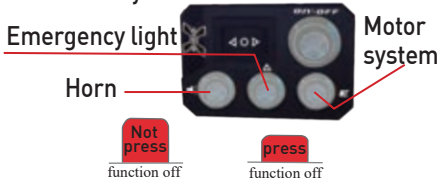

Step4 Deceleration and braking using electronic brake

Set the use and strength of the electronic brake among the detailed functions of the instrument panel before driving. When the brake lever works, the electronic brake works together to increase the braking force.

Tip Check for safe braking

- For safe braking, check whether the brake lever and disc caliper connection (wire damage, external breakage, etc.) are damaged before and after driving, and check brake wear and looseness of brake inner core (inner wire). In the case of hydraulic brakes, it is also necessary to check the oil leakage or deficiency and always check that the braking force is sufficient.
- Due to various factors such as road surface condition and speed, it may not always be possible to come to a complete stop even when the brake is operated as expected. The electronic brake and ABS functions are auxiliary functions to further increase the braking force. The user should understand the function and expect the operation timing when using this function.

4) Product Folding

Handlebar slider

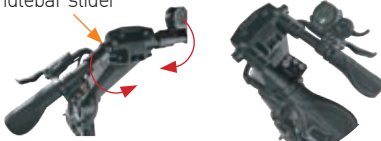

1. Releasing fixed handlebar

Pull both side handlebar slider, and fold forward

Folding knob



2. Folding Steering Tube

Unlock folding knob and press the knob hard then folding the steering tube.

How to use the instrument panel **⚠ CAUTION**

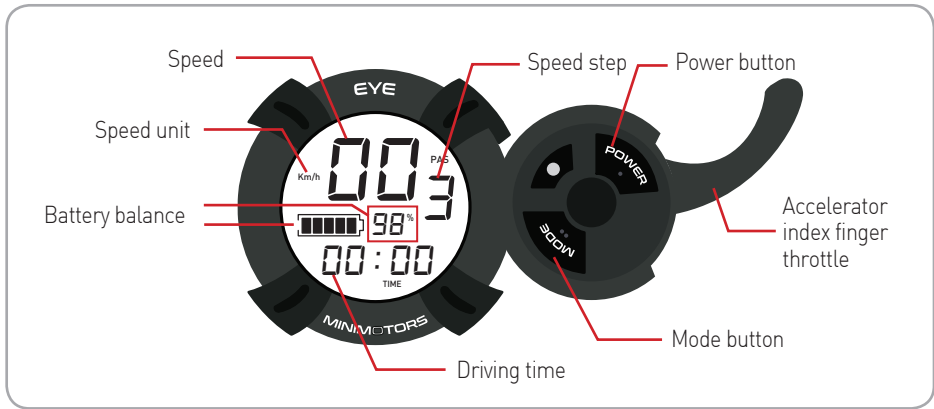

1) Speed step setting Can adjust with button.

While the instrument panel is on, press to set the speed step.

The setting is completed when the selected speed step value is selected.

* Blinks 3 times per 10 seconds when the remaining battery power is 10%.
It blinks continuously when the remaining battery power is 10%.

2) Functions and settings for each main screen mode can adjust with button.

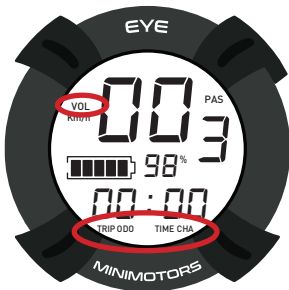

Mode	Discription
TRIP	Current mileage (Press and hold mode button to reset to '0')
ODO	Accumulated mileage
CHA	Not in use
VOL	Current voltage
TIME	Drive time

3) Instrument panel detailed function









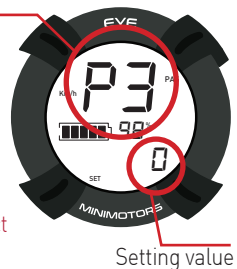





You can change the setting mode by turning on the power of the dashboard and pressing for 2-3 seconds.

In the setting mode, press once to change the internal setting value

* If you change default setting value P0(13), P1(72), 3 P2(15), P3(0) the exact information is not displayed.

Setting mode



 13(Fixed)	 72(Fixed)	 15(Fixed)	 0(Fixed)	 Speed unit 0(Km/h), 1(mp/h)
 Start method 0(Acceleration start), 1(Kick start)	 Cruise mode 0(OFF) 1(ON)	 Slow start 0(Off:Power start) ~5(Slow start)	 Max output 5-100% (User adjust)	 Battery save 1(MAX SAVE) 2(MID SAVE) 3(NO SAVE)
 Electronic brake power 0(Off) ~5(Powerful)	 LCD brightness control 0(Back light off) ~5(Brightest)	 Auto off time setting 5-30 minutes	 ABS setting 0(OFF), 1(ON)	

4) Features of cruise mode (automatic driving)

The cruise control function allows you to maintain the driving speed automatically.

Take advantage of cruise features to reduce fatigue when traveling long distances and to increase mileage of driving due to constant speed driving.

- **The start of the cruise function**

Select the Cruise function section of the dashboard under 'Settings' and maintain the throttle to the same Acceleration for 7 seconds the cruise function will start.

- **End of cruise function**

When you hold and release the brake while cruise mode is in effect, the cruise mode is automatically released.



- **Precautions when using the cruise function**

1. In case of cruise function, please ride in a position where brake can be used immediately so that cruise function is canceled and braking is possible in preparation for safety situation while driving.
 2. It is permanently dual drive mode and can be released via throttle and brakes.
- * It is not recommended that cruise function is disabled via the throttle.

CAUTION

5) Setting of Electronic brake

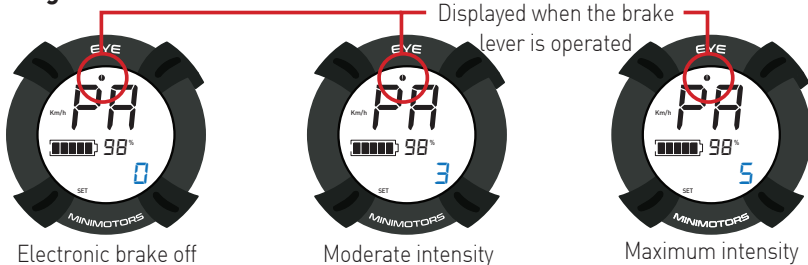

How to use the instrument panel

* Precautions when using electronic brake after a full battery charge



The electronic brakes do not operate when the battery is fully charged, so be sure to check and operate this device.

When the battery is used a little, the electronic brake will operate normally.

6) ABS function setting guide

All electric scooters are subject to sudden braking, causing the wheels to stop spinning (Tire Lock).

As a result, the slip of tire can cause the driver to fall down, which can cause accidents.

This product is equipped with ABS brake function to reduce the tire lock, enabling more secure braking.



ABS OFF



ABS ON

(1) ABS function ON

Set the ABS function part Pd of the dashboard to 1.

(2) ABS function OFF

Set the ABS function part Pd of the dashboard to 0.

* If Pd - ABS function 1 (ON), PA - electronic brake function will operate maximum, when the ABS function is disabled, the previously set electronic brake actuation value is applied.

* ABS brake is an abbreviation of Anti-Lock Brake System. It uses the principle that maximum static friction force is larger than kinetic friction, so that braking distance (distance from breaking to stopping) is shorter than the normal brake. It has the advantage that the vehicle does not slip well when wheel is rotating. And it is a brake assist system that can stop more safely without tire lock and slip.

Electric scooter Anti-Lock Brake System Patent pending : 10-2018-0045825

* Precautions when using the ABS function



ABS has the advantage of being able to stop at the shortest braking distance that can be obtained from the tires and road conditions.

However, due to the principle of repeatedly holding and releasing the brake several times in a second, a lot of vibration occurs in the motor and the body.

Repetitive vibration caused by this may cause frequent loosening of the motor, rim, fixing part, and body fixing bolt.

7) Self-diagnosis through dashboard



Fault type	Diagnosis	Solution
②	System error	* If the error information appears, immediately stop using the product and take the scooter to the service center before use. Excessive use can result in damage to the product and safety accidents.
④	Motor error	
⑤	Accelerator error	
⑥	Controller error	
⑦ ⑧ ⑨	None	

* The number ① is displayed when the cruise function is executed at a constant speed.

* The number ③ is displayed when the brake lever is operated.

(When the indicator lights, the accelerator does not operate.)

1) Remote control functions and settings

The LED remote control is infrared. Please aim at the bottom of the right LED bar.

Brightness&Light speed &Number of lamp beads control block

Multicolor light mode selection block

Light change mode selection block

Whole white lamp

Power button

Remote receiver
The lights will only be controlled when you operate the remote towards this place

2) LED function guide

When the LED is turned on, the main power is turned on and the LED bar is lit when the throttle power is turned on. Make sure that the LED lamp button on the right side of the deck is turned on.

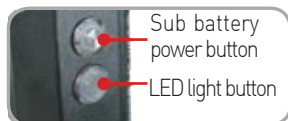

* LED Light Emitting System Cover Precautions

Cracks in the LED cover can be caused by direct sunlight or by polish, oil, wax etc. used for product maintenance. When using and servicing the product, always be careful not to contact the LED cover with direct sunlight, polish or alcohol.

*Solvent crack is a fine crack that occurs when a solvent touches the surface of a resin molding product. Solvents include not only chemicals such as alcohol, but also oils, waxes and cosmetics that are commonly used in everyday life.



3) Voltmeter function guide

Battery Voltmeter is basic mounted and can check real-time battery voltage.

■ Main battery voltmeter

Battery volts are displayed when power on main battery

■ Sub battery voltmeter

Sub battery voltmeter displayed when press power button located on handle steering tube right side.



4) How to use USB Charging Terminal

The USB charger operates as a sub-battery power source and can easily charge mobile phones, action cams, etc. within the allowed output range.

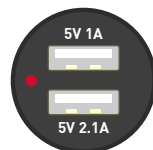

* Precautions when using USB charging terminals

USB charging terminals and products may be damaged when connecting high-power devices that are not allowed to USB charging terminals.

* To prevent infiltration of moisture and outside substances, always close the USB protective cap after use.



How to use the charger correctly

1) Basic charging method

1. Open the charger port cap and connect it to the connector of the charger and connect it to the household outlet.

3P charger connector
(Handle part 1ea)



3P fast charger connector
(Main frame 3ea)

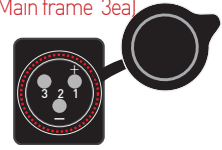

2. Charging status indicator
 - (Red) Charging
 - (Green) Charging complete



3. Be sure to close the charger port cap when driving or storing except when charging.
4. When connecting the connector to the charger port, there may be metallic sparks due to voltage difference, but this is normal.

2) Basic charging method

* Failure of the charger and abnormal conditions can cause electric shock and fire. Learn the correct usage and prevent safety accidents in advance.

<p>1. Manufacturers and sellers are not responsible for any problems arising from any disassembly, modification, or mixing with other chargers.</p>	<p>2. The charger is forbidden to be used in places subject to high humidity, heat, flammable materials, confined spaces, or where there is no ventilation such as in a car.</p>
<p>3. The charger is not waterproof. It is thoroughly controlled to prevent moisture from entering the charger.</p>	<p>4. Children and pets should not be allowed to approach the charger when they come into contact with them, as they may cause an electric shock.</p>
<p>5. If the charger lamp does not light, charger fall down, strong external shock, long time charge, or cable cover damage, discontinue use immediately and contact the service center</p>	<p>6. Unplug the charger when you are away from the home for long periods.</p>

7. Use only genuine charger.

8. Do not insert conductors into the charging port.

9. Do not touch the plug for about 10 seconds after unplugging the charger. There is a risk of electric shock from instantaneous discharge.

10. Do not remove the terminal during charging. Otherwise you may charge the internal circuit of the charger and cause malfunction.

11. Do not operate the product during charging.

12. Charging terminals should be firmly contacted during charging and should not be used if terminals are corroded or damaged.

13. When disconnecting the charger from the product, it is safe to hold the terminal without holding the wire.

14. Be sure to keep the charger disconnected from the product after the charging is complete.

The charger must be disconnected if it is not used for longer than a few days, as there is a risk of overcharging when charging more than the time indicated on the product specifications.

⚠ WARNING

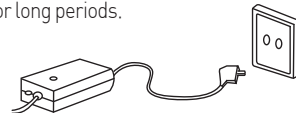



- 1) Care** Lithium batteries should be protected from direct exposure to children and pets.
- 2) Performance**
1. Lithium battery is affected by external temperature. In the winter, when the temperatures are low, the performance of the battery may be temporarily deteriorated and the mileage and power output is reduced.
 2. Lithium battery has a characteristic that discharge performance is reduced by more than 15% when charging / discharging 300 times or more. If usage time is shortened due to long usage, it should be replaced with a genuine one through the nearest point.
- 3) Charging**
1. Lithium battery should be used only with genuine battery and charger supplied from the manufacturer. Any problems caused by use of battery made by the manufacturer, mixed use, or using the charger are not covered by the manufacturer.
 2. Charging the lithium battery with a non-genuine charger may cause malfunction or fire.
 3. The lithium battery should be charged in a well-ventilated, dry place and around the charger in a place where there is no flammable material.
 4. Lithium battery should be charged at 0 ~ 45°C and discharged within -10 ~ 60°C .
The sub-battery must be charged at 0 to 50°C and discharged within -20 to 75°C .
Charging or discharging at a temperature outside this range may cause malfunction, fire or explosion.
 5. In case of moving from cold outside to warm indoor, please charge it after 1 ~ 2 hours.
This is to prevent condensation from occurring inside the product due to the temperature difference.
- 4) Storage**
1. Lithium batteries should be kept away from snow, rain and direct sunlight.
Do not store or charge them in a trunk or hot room.
Select a dry place and store at room temperature (10 ~ 20 °C).
 2. When storing for more than 3 months, charge the remaining battery level to 70 ~ 80% (do not store full charge).
- 5) Trouble symptom, safety**
1. Lithium battery should be discontinued immediately if it is damaged or there is leakage of battery, sour odor, appearance deformation, etc. Please contact the place of purchase to get technical support and service.
 2. If overheat, smoke, or ignition is detected in a product with lithium battery, immediately stop charging and use, move the product outdoors as soon as possible, and then use a fire extinguisher to extinguish flames. Do not spray water or immerse the product in any situation, which can lead to more danger.
 3. Lithium battery pack has very high energy density, so if you charge the battery for a long time and there is a case of short-circuit, leakage, bad battery, etc., it can lead to ignition.
Therefore, you should avoid charging for a long time without a person being present to avoid the risk of unexpected fire.
- 6) Misuse** If the lithium battery is short-circuited, the polarity is changed, or if the battery is impacted, malfunction or fire may result.
If you think that the battery has been impacted, you should stop charging and using it and visit the nearest service center for inspection.
- 7) Water inflow** It should be controlled to prevent water inflow into the lithium battery.
There is a risk of fire or electric shock if the charger is connected while moisture is present.
- 8) Caution** Disconnect the battery from the main unit except when recharging and reinstalling.
Do not use for any other purpose.
- 9) Disposal** When disposing of the lithium battery, the battery should be separated from the product at the point of purchase or near the service center and the charge and discharge terminals are not short-circuited. Dispose of it as industrial waste.



Battery disassembly prohibited

Battery disassembly, modification, and repair are not covered under warranty.

Safety guidelines before driving

1) Required checking before use

1. Check throttle and handle

- Operate the accelerator throttle lever about 2 ~ 3 times to check whether it returns to the home position.
- Be careful that excessive throttle leaning and manipulation of the throttle can cause malfunction due to internal parts damage.
- Check for free gap in the handlebars before using.



2. Check brake and cable

- The brake braking force is sufficient to check the operating condition. If the braking force is significantly lowered, use it immediately after inspection and action.
- Check that the brake pad is not worn, that the cable is not loose, that the cable is not damaged, and that there is no leakage in the case of hydraulic brakes.
- If there is an unusual feeling or noise during operation, check for breakage, wear, and deformation of the inner wire of the brake cable.
- Check that the bolts and nuts of the brake fixing parts are not loose and that the disc is not deformed or damaged.



3. Check tire pressure and abnormal tread wear

- Check the front and rear tires for wear and punctures and check the value marked on the surface of the tire. When the air pressure is shortened, the possibility of puncture increases, so check always.
- It is necessary to judge the replacement time by observing the appearance of the tire such as tire damage, uneven wear.



4. Tightening check such as folding part and handle part

- Make sure that the bolts and nuts of all parts of the product are tight and safe from loosening. Check the fastening condition and clearance of the folding and fixing parts of the handle (folding knob, swing arm, etc. folding related parts, suspension arm bolt, swing arm bolt).



* In these cases, stop driving immediately.

If you encounter any of the following situations while driving, stop driving immediately and contact your nearest branch or service center for proper measures.



If you provide pictures and videos to get an accurate diagnosis, professional counseling is available.

- Unusual heating of the motor
- Brake braking status error
- Error messages on the instrument panel
- When the throttle is not returned to its original position
- When the battery doesn't fully charge and shorter riding distance after a full charge (Battery explosion may cause due to faulty battery cell or battery cell breakdown)
- Abnormal noise is generated
- Product smoke, ignition, sour odor
- When rain or wet with water or in a similar situation
- When other driving is judged to be unreasonable

2) Maintenance and self-maintenance

Electric products can be damaged by various factors. The life span of each part varies depending on driving habits and driving environment. Parts that exceed the service life may cause accidents. Let's manage various parts and prevent safety accidents in advance.



1. Check the replacement timing of consumable parts

- ① The components and suspension parts of the swing arm, tires, wheels, bearings, discs, brake pads, cables and folding parts, various brackets and other consumable parts require periodic inspection and must always be checked.

Parts Replacement Schedule		
DUALTRON X II		
No.	Parts name	Replacement cycle / km
1	HANDLE BODY	3YEARS / 20,000
2	STEERING TUBE	3YEARS / 20,000
3	BATTERY	2YEARS / 20,000
4	Other chassis components	If the exterior is damaged or deformed

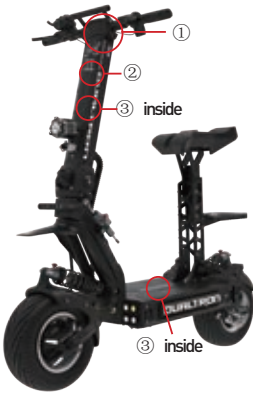

2. External damage inspection by driving environment



- ① Replace parts that may be damaged by the external driving environment, such as deformation of parts or tiny cracks due to pressure.
- ② If the product is exposed to strong sunlight for a long time, discoloration may occur.
- ③ In case of jumps, slight impacts such as turning, collision, etc., when driving frequently or for a long time in a poor road condition or driving for thousands of kilometers or more, fatigue breakdown phenomena may happen so please check the parts replacement schedule for each product and replace accordingly for safety.
- ④ Fatigue breakdown and maintenance parts may differ from the example conditions depending on the driving environment and the operating conditions. Also check parts other than the replacement cycle (maintenance parts) at all times to check for any signs of abnormality.

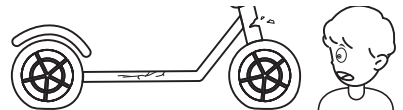

Important check list

Important notice

* Metal vibration may occur due to motor vibration and the vibration of the brake disc and pad during the load section that accelerates during driving. (About 15 – 30Km, different for each product)
This is a phenomenon in which all rotations (fans, automobiles, ships, etc.) are vibrating at a specific rotational frequency (rpm) rather than the product.

However, if the continuous noise or metal noise is large, there is a possibility that the disk will become bent and deformed.

* Please note that after running, there is a risk of burns due to the heat on the motor and brake (especially disk rotor) side.

* Be careful that the bolts of the motor, rim, and motor shaft may become loosened due to the ABS function.

* For inspection and repair, remove the side cover, attach the power switch, and attach it with the product's standard bolt. When tightening, carefully remove the cover of the wiring. Bolts other than the rule bolts (long bolts) can cause serious damage to the battery casing (battery cells), which can cause fire or safety accidents.

※ Folding parts and joints where movement occurs due to product characteristics can naturally damage the surface or paint surface during use, especially when operating in incorrect operation and form.

※ When inspecting the product, keep two wheels away from the ground and work on a safe workstation.

3) Maintenance by self-maintenance

1. Brake adjustment method

As you continue to use the brakes, the brake pads will become worn out and the gap between the pads and the brake disc will become wider.

If the braking force drops, use a 5mm hexagon wrench to loosen the brake arm wire bolt, then lift the brake arm upwards to adjust the braking force.



2. How to replace a tire

1. Remove the motor shaft nut (18 mm) after removal of the caliper bracket and the brake caliper, and release the tightening bolt to which the motor and wheel are connected.

2. After deflating the tire, press the tire to separate it from the wheel.

3. After replacing the tire, complete the assembly of the tire in reverse order. After assembly, apply a good fit to the main frame and tighten the screws and bolts to secure.



- ※ • After the tire has been replaced, run a simple test drive to match the pressure marked on the side of the tire.
- Patch seal (worm) can be used for repair in case of a puncture. Use tires for continuous inspection and check.

Easywheel System

- Full removable hub motor design

By designing rims and hub motors to enable complete separation, we have greatly improved the maintenance and maintenance of products by allowing only rims to be replaced without replacing the motor in the event of rim failure (Patent pending).

3. Causes and countermeasures of disc brake noise

The disc braking have good braking power so many electric scooters use the disc brake. However, you may hear a sharp hissing sound when you hold the disc brake because of dust or sand particles on the ground popping up on the surface of the disc, causing foreign substances to be on the brake pads or disc surface, or bending due to heat or external impact.

If that happens, clean the inner surface of the disc by turning the wheels with a clean, dry cloth and straighten any bent discs.



⚠ CAUTION

If you maintain the product using the above methods, please visit the nearest branch and get a safety check as there may be another problem.

4. How to adjust handlebar gap

If there is a free gap on the handle, use a 2.5mm or 3mm hexagon wrench to fine-tune the adjustment bolt that is visible when the handle is folded, then extend the handle to check the free gap condition. If there is a gap, rotate it a little until there is no gap.

* CAUTION : When adjusting for free gap, do not fully unfold the handle when the bolt is protruding more than necessary, and excessive coupling may cause external damage to the handlebars. If the handlebars are not normally combined with the handlebars, tighten the adjusting bolts clockwise again to reduce the protrusion.

5. How to adjust the gap in the folding section

If there is a free gap in the folding part, tighten the folding knob completely to clear the free gap.

If product folding is not required (always unfolding)

⚠ CAUTION

Remove the bolt protection caps on both sides of the front folding hanger and tighten the bolts to ensure that they are un-folding at all the time.

If you work in reverse order, you can do folding.



• **Adjust the height (by weight)**

You can adjust the height by turning the ring.



suspension control ring

• **Suspension strength control**

Turning the hydraulic control lever to adjust the suspension strength. (You can adjust it according to your weight and personal softness preferences.)



Hydraulic control lever

* When adjusting the suspension ring, the wheels must be raised from the ground before adjusting.

Product Specification

Product Name	Dualtron X-II UP		
Motor	Max 8,300W BLDC DUAL HUB MOTOR		
Battery Capacity	Main: 72V45AH Sub: 11V12.8AH	Main: 72V36AH Sub: 11V12.8AH	
Charging Time	Main : 9hr Sub : 2.5hr	Main : 7hr Sub : 2.5hr	When use 1unit 5A fast charger(3P) When use 1unit 4.5A chargr(3P)
Max Speed	Over 110km/h		75kg,83V,full charging,flat road. *Max mileage could be shorter depending on the driving environment.
Mileage(ECO)	Above 190km	Above 155km	
Gradeability	Around 70%(Around 35°)		Gradeability depends on the weight of rider,road condition battery condition,temperature.
Max Load	150kg		Max 120kg is recommended
Product Weight	Around 66kg		
Folding	Turn & Push Release		Patent pending
Unfolding Size	1305 x 632 x 1240mm		Length x Width x Height
Folding Size	1305 x 350 x 780mm		Length x Width x Height
Instrument Panel	EYE throttle is applied as the default option.[Bettery level, TRIP, ODO, Time, Speed display and mode change.]		Cruise / Electronic brake / Auto save function / ABS
Light	Front high-power LED light + Steering tube & wheel cover & side deck RGB lights, bottom mood LED & taillight, warning lights & brake lights are built in		
Suspension	Hydraulic bike tuning 19step		
Brake	Hydraulic brake+160mm rotor		Common use for front and rear wheel
Tire	13inch ultra wide tubeless tire (Maximum air pressure is marked on the side of the tire)		Fully detachable Hub Motor design (Patent pending)
Product material	Frame and handle: Aviation aluminum forging alloy, Shaft: SCM, Covers: Polypropylene		

*The specification can be changed by manufacturer without notice to improve the quality and safety for users.

*The distance can be affected by loaded weight, wind direct (wind speed), road condition, slope and tire condition.

MEMO

Electric wiring diagram

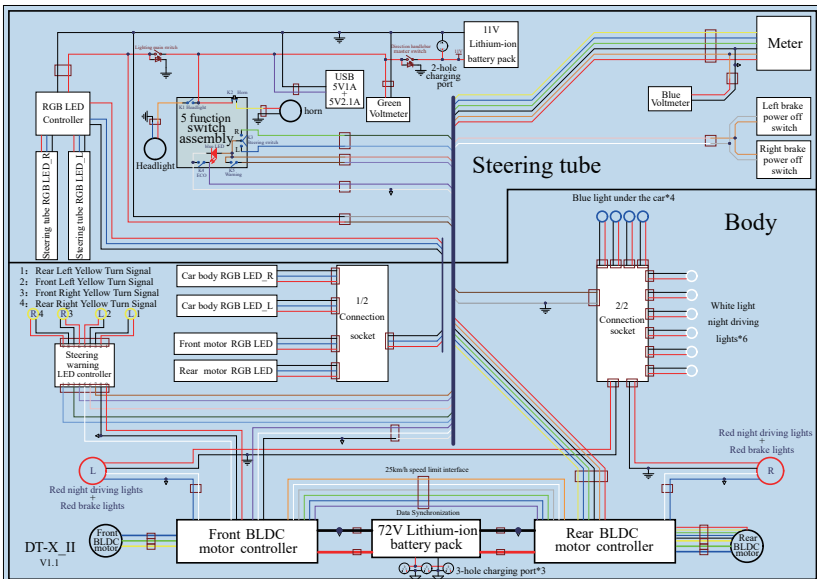

DUALTRON X II UP

Electric Scooter User Manual

Zhejiang Minimotors Bike Co., Ltd.
No.1, Baolong road, Lanjiang Street,
Lanxi Economic development zone,
Jinhua city, Zhejiang province, China

www.dual-tron.com

