



Divisiones y puertas de paso
Glazed room dividers and doors
Divisions et portes d'accès

NEW

Multiplo Compact Glass

SOFTPRO[®]
TECHNOLOGY by Saheco

saheco
sistemas para puertas correderas

SV-T-PRO X110

(TELESCÓPICA)

SV-T-PRO X110

Multiplo Compact Glass

+ info saheco.com



ES

La familia Multiplo Compact Glass es la mejor opción para cerrar espacios grandes con múltiples hojas de vidrio. Ésta familia incorpora como novedad la tecnología **SOFTPRO** de Saheco, una característica que aporta mayor suavidad y seguridad en la apertura y en el cierre de la instalación.

SV-T-PRO X110 permite colocar 2 hojas de hasta 110kg por hoja con el objetivo de recogerlas en un único lado de la instalación, bien a izquierda o bien a derecha. La apertura y el cierre se desarrollan de forma suave arrastrando las dos puertas con un solo movimiento.

Ésta familia tiene dos acabados disponibles: Aluminio anodizado plata mate y Aluminio cepillado acabado Inox.

Además, el sistema ha sido probado en 100.000 ciclos según normativa europea EN1527 / EN1670.

EN

The Multiplo Compact Glass family is the best choice for closing large spaces with multiple sheets of glass. This family incorporates the new **SOFTPRO** technology of Saheco, a characteristic that brings greater smoothness and security in the opening and closing of the installation.

SV-T-PRO X110 allows you to place 2 sheets of up to 110kg per sheet with the aim of collecting them on a single side of the installation, either left or right. The opening and the closing are developed smoothly dragging the two doors with a single movement.

This family has two finishes available: Matte silver anodized aluminum and Brushed aluminum finish.

In addition, the system has been tested in 100,000 cycles according to European regulations EN1527 / EN1670.

FR

La gamme Multiplo Compact verre est la meilleure option pour fermer de grands espaces avec de multiples panneaux de verre. Cette nouvelle famille, incorpore la nouvelle technologie **SOFTPRO** SAHECO avec une fonctionnalité qui vous donne plus sécurité dans l'ouverture et la fermeture de l'installation.

SV-T-PRO X110 permet de placer 2 feuilles de jusqu'à 110 kg chaque, afin de recueillir sur un côté de l'installation, soit à gauche ou à droite. L'ouverture et la fermeture se développent en faisant glisser doucement les deux portes en un seul mouvement.

Cette système a deux finitions: anodisé argent mat en aluminium et finition en aluminium brossé Inox.

En outre, le système a été testé dans 100.000 cycles selon la norme européenne EN1527 / EN1670.



Sara Valentina
www.ivetralto.it

hasta 1 up to 1 jusqu'à 110 kg |
242 lb por hoja 1 per panel 1 par panneau

SV-T-PRO X110



Quality Certificate	Details			
UNE EN 1527 Categories	Durability 6	Door Weight 110 Kg	Corrosion resistance 3	Type of door Glass
Durability	100.000 cycles			
Corrosion	Grade 3 Suitable for humid environments			



Multiplo Compact Glass

SOFTPRO®

TECHNOLOGY by Saheco

La nueva tecnología
de frenado suave
de Saheco SOFTPRO®

SOFTPRO® The new
soft-closing technology
from SAHECO

La nouvelle technologie
de système de freinage
de Saheco SOFTPRO®

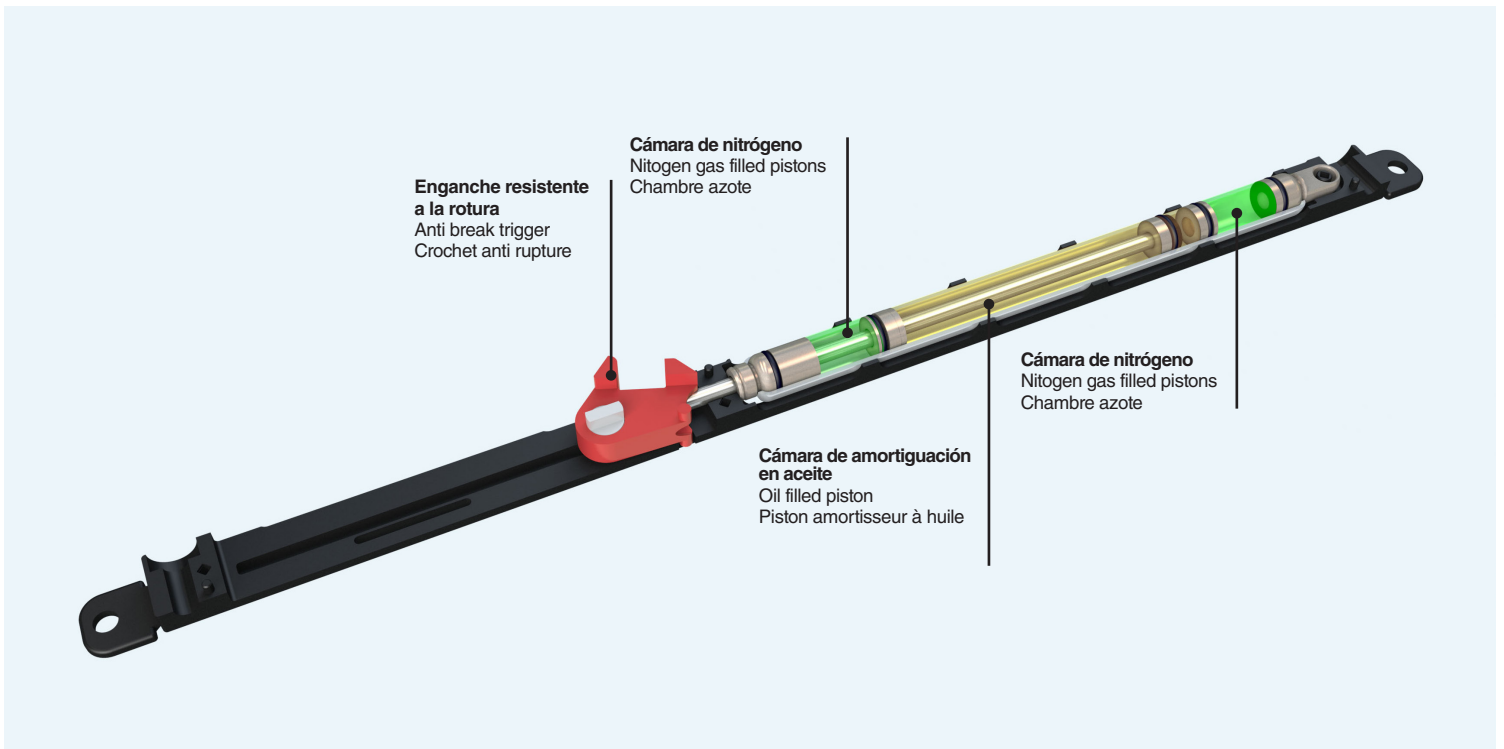

La nueva tecnología SOFTPRO® de frenado suave combina la función de dos pistones a gas y un amortiguador de aceite en un único componente.

Ofrece 4 funciones distintas:

- Velocidad de cierre ajustable
- El cierre es progresivo y se ralentiza cuando la puerta se acerca a la posición completamente cerrada
- Cierre suave
- Enganche resistente a la rotura

Garantiza un frenado seguro y evita el rebote de la puerta.

Proporciona un movimiento armónico y una amortiguación segura del cierre de la puerta hasta 110 kg.

SOFTPRO® The new soft-closing technology from SAHECO which combines two nitrogen gas filled pistons and one oil filled piston all within the same unit.

Features:

- Fully adjustable closing speed
- Closing action is PROGRESSIVE and slows down as the door approaches the fully closed position
- Soft Closing
- Anti break feature on the trigger

Ensures safe braking and Prevents bouncing of the door.

·Ensures the door is braked SAFELY
·Ensures the door is held firmly in the closed position
·Combines an aesthetically pleasing action with safe soft closing for door weights up to 110Kgs.

La nouvelle technologie de freinage SOFTPRO® fonctionne grâce à la combinaison de deux pistons à gaz et un amortisseur à huile.

Offre 4 types de fonctions:

- Ajustement flexible
- Frein progressive
- Freinage douce
- Crochet anti-rupture

Garanti un freinage fiable évitant le refoulement de la porte.

Apporte un mouvement esthétique et un amortissement fiable de fermeture de porte jusqu'à 110kg.

SOFTPRO[®]

TECHNOLOGY by Saheco

CARACTERÍSTICAS SOFTPRO[®]

Frenado progresivo de los últimos 65 mm de recorrido de la puerta, para hojas de hasta 110kg.

FEATURES SOFTPRO[®]

Progressive soft closing for the last 65mm of the doors travel into the fully closed position for door weights up to a maximum of 110Kgs.

CARACTÉRISTIQUES SOFTPRO[®]

Freinage progressif de derniers 65mm de parcours de la porte, pour panneaux jusqu'à 110kg.



Para más información vea el video de instalación en:

To get more information please watch the video at:

Pour avoir plus info regarder la vidéo de installation à:

www.saheco.com



hasta 1 up to 1 jusqu'à 110 kg |
242 lb por hoja | per panel | par panneau

SV-T-PRO X110

Multiplo Compact Glass

Características técnicas

Technical characteristics | Caractéristiques techniques

Pictogramas | Pictograms | Pictogrammes

Perfilería Profiles Profils

STANDARD
 STANDARD VIDRIO FIJO I
 FIXED GLASS I VERRE FIXE

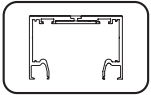

10 mm - 103x70 mm
 12 mm - 107x70 mm

FT
 FT VIDRIO FIJO I
 FIXED GLASS I VERRE FIXE

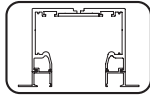

10 mm - 103x87 mm
 12 mm - 107x87 mm

Especificaciones Specifications Spécifications

STANDARD
 STANDARD VIDRIO FIJO I
 FIXED GLASS I VERRE FIXE



10-12 mm

FT
 FT VIDRIO FIJO I
 FIXED GLASS I VERRE FIXE



10-12 mm

STANDARD
 FT



20 mm

STANDARD VIDRIO FIJO I
 FIXED GLASS I VERRE FIXE
 FT VIDRIO FIJO I
 FIXED GLASS I VERRE FIXE



10 mm - 12 mm
 12 mm - 11 mm



SOFTPRO simple / double
 55kg / 110kg
 MIN. 970 mm / MAX. 1600 mm
 Doble freno retenedor
 MIN. 600 mm / MAX. 1600 mm



MÁX. 110 kg

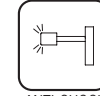

ANTI-SHOCK



RODAMIENTO A
 BOLAS BALL BEARING
 ROULEMENT À BILLES

Peso | Weights | Poids

hasta 1 up to 1 jusqu'à **110 kg** por hoja | per panel | par panneau

hasta 1 up to 1 jusqu'à **242 lb** por hoja | per panel | par panneau

Variantes de instalación | Installation possibilities | Variantes d'installation



Sección tipo

Cross-section | Section type

(Cotas en mm / Dimensions in mm / Dimensions en mm)

SV - T-PRO X110

(MONTAJE A TECHO | CEILING MOUNT I
 ASSEMBLAGE A SOSTRE)

SV - TPRO X110

(MONTAJE A TECHO | CEILING MOUNT I
 ASSEMBLAGE A SOSTRE)

(OPCIÓN VIDRIO FIJO I FIXED GLASS
 OPTION I OPTION VERRE FIXE)

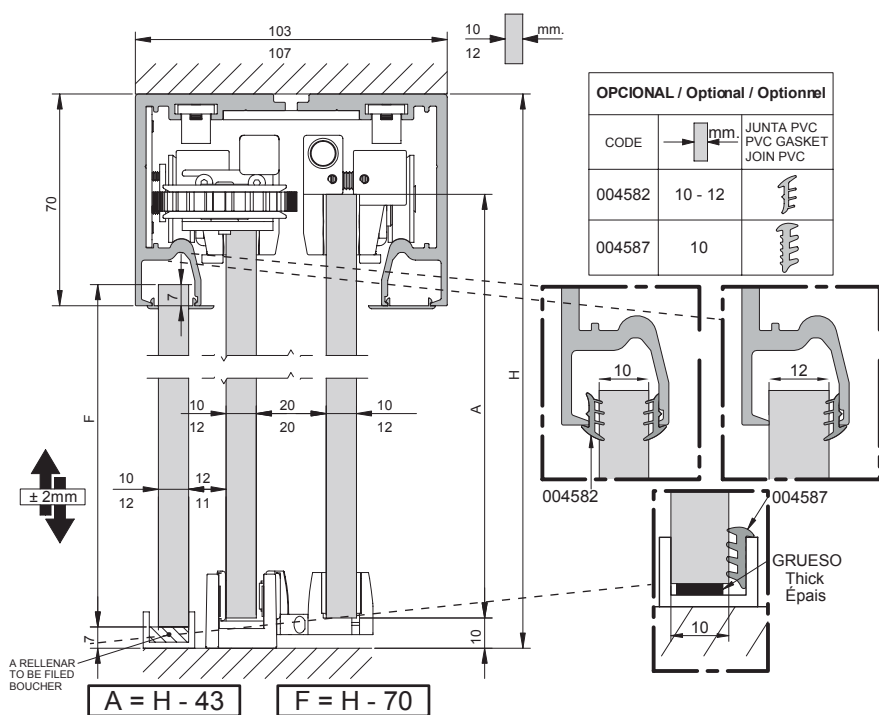
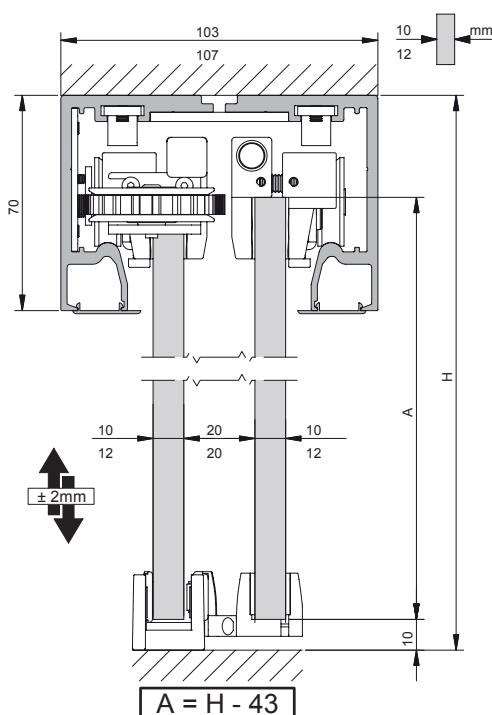



Sección tipo

Cross-section | Section type

(Cotas en mm / Dimensions in mm / Dimensions en mm)

SV - T-PRO X110

(MONTAJE A FALSO TECHO | FALSE CEILING MOUNT | ASSEMBLAGE FAUX PLAFOND)

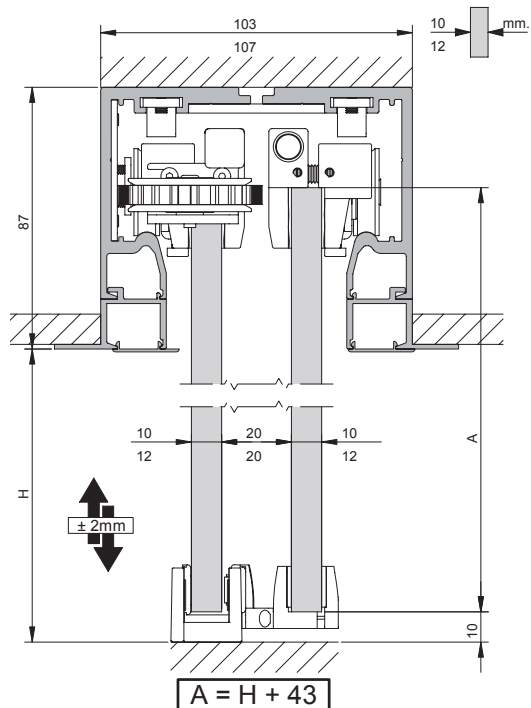

SV - T-PRO X110

(MONTAJE A FALSO TECHO | FALSE CEILING MOUNT | ASSEMBLAGE FAUX PLAFOND) (OPCIÓN VIDRIO FIJO | FIXED GLASS OPTION | OPTION VERRE FIXE)

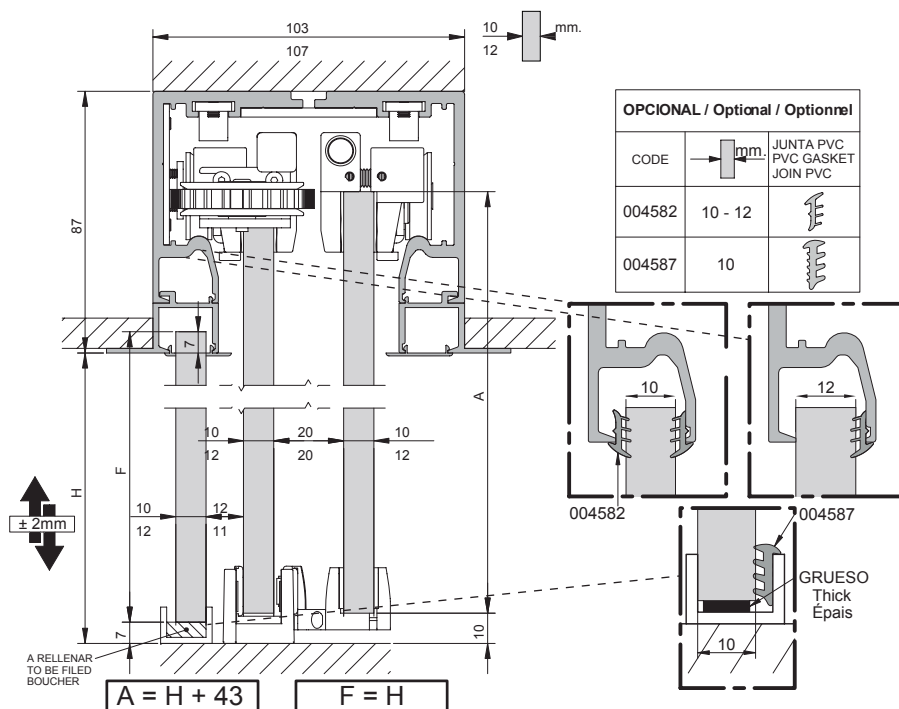

hasta 1 up to | jusqu'à 110 kg |
242 lb por hoja | per panel | par panneau

SV-T-PRO X110

Multiplo Compact Glass

Sistema de montaje

Assembly system | Système de montage

SV - T-PRO X110

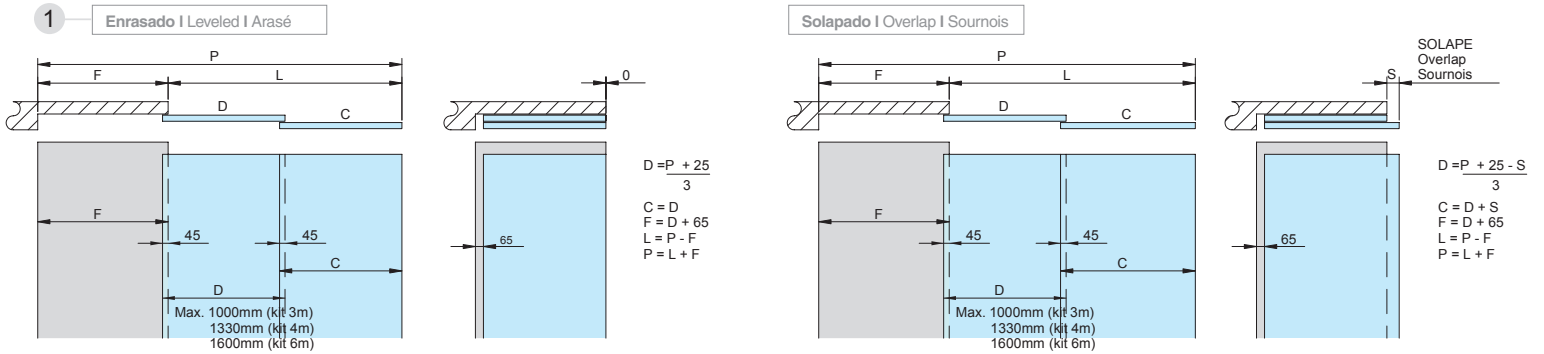

SV - T-PRO X110

(MONTAJE PINZAS | CLAMPS ASSEMBLY |
ASSEMBLAGE PINCES)

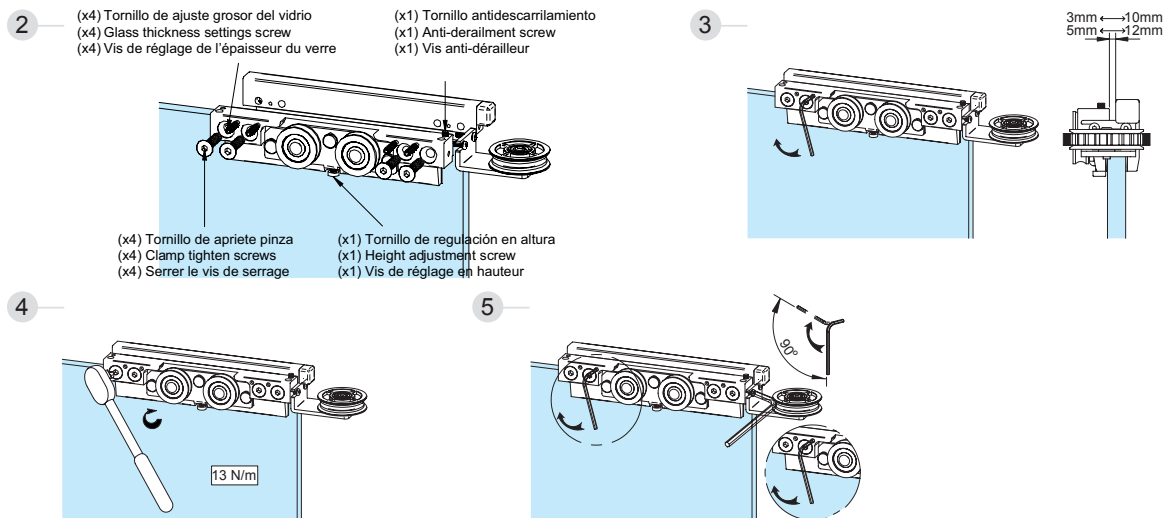

6

Softpro doble 55kg | Double Softpro 55kg | Softpro double 55kg

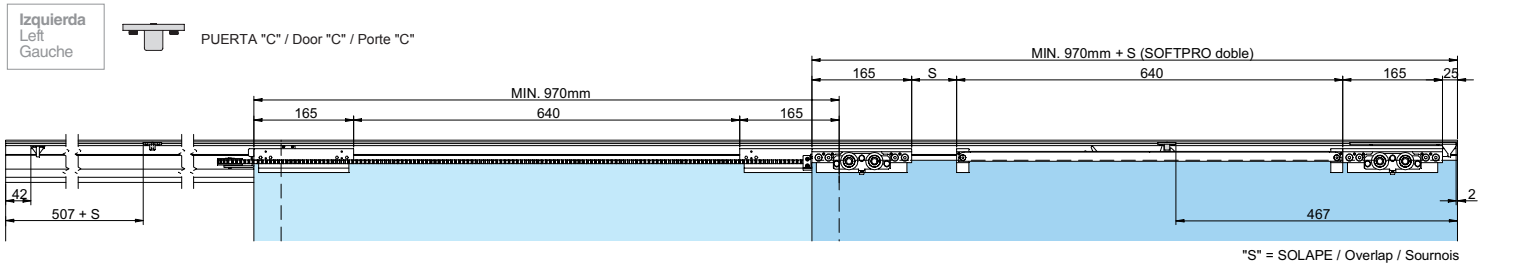

Softpro doble 110kg | Double Softpro 110kg | Softpro double 110kg

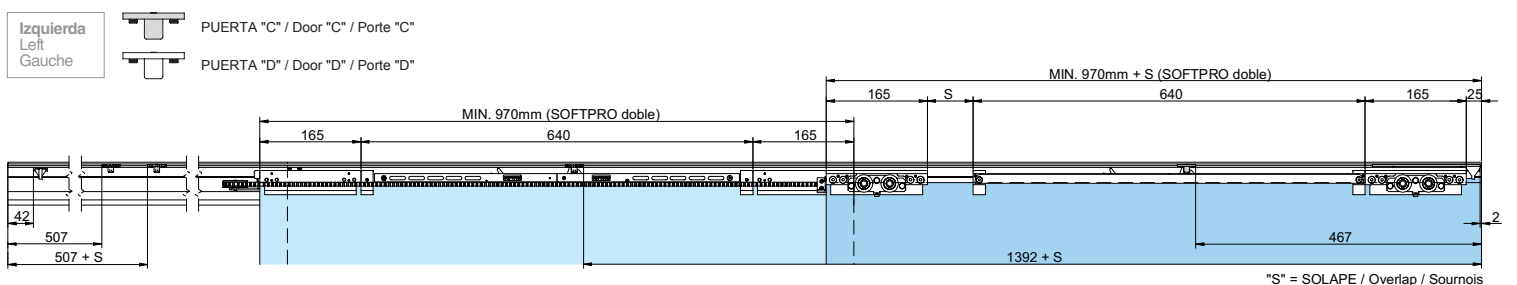



Softpro simple 55kg + Anti-shock | Simple Softpro 55kg + Anti-shock | Softpro simple 55kg + Anti-shock

Izquierda
Left
Gauche



PUERTA "C" / Door "C" / Porte "C"

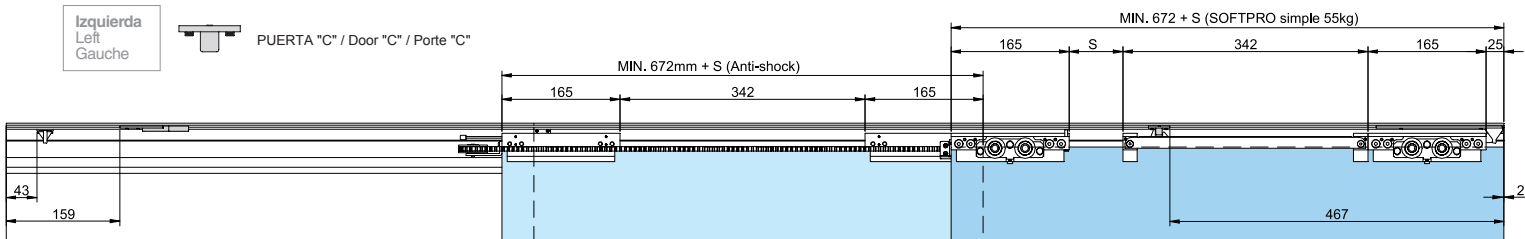

"S" = SOLAPE / Overlap / Sournois

Softpro simple 110kg + Anti-shock | Simple Softpro 110kg + Anti-shock | Softpro simple 110kg + Anti-shock

Izquierda
Left
Gauche



PUERTA "C" / Door "C" / Porte "C"



PUERTA "D" / Door "D" / Porte "D"

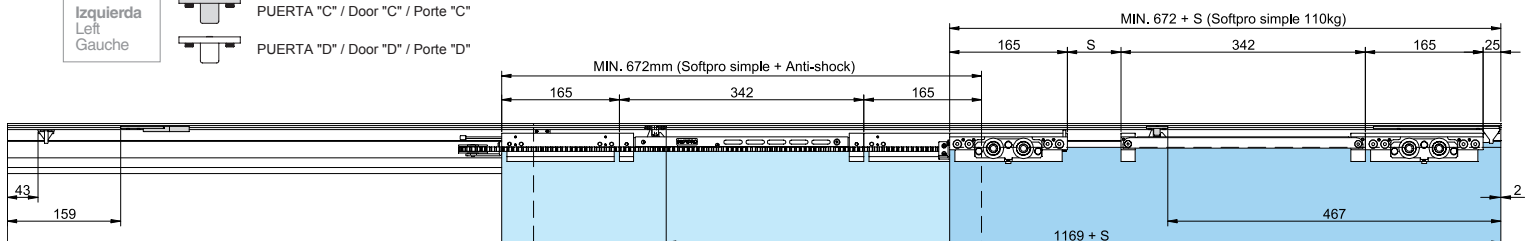

"S" = SOLAPE / Overlap / Sournois

Freno retenedor | Retaining brake | Frein de retenue

Izquierda
Left
Gauche

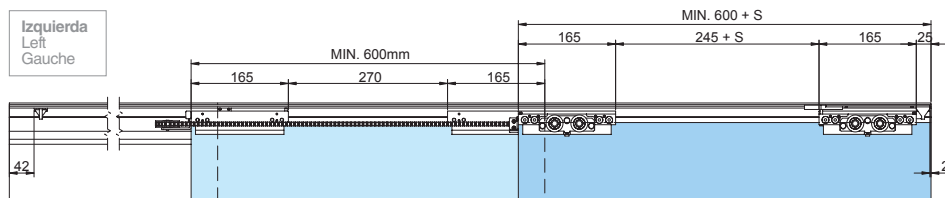

"S" = SOLAPE / Overlap / Sournois

SV - T-PRO X110

(MEDIDA CORREA | LEASH MEASURE |
MESURE CINTURON)

7 MEDIDA CORREA | LEASH MEASURE | MESURE CINTURON
2 x (D + 140 mm)

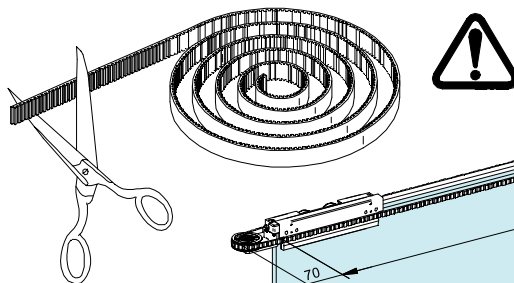
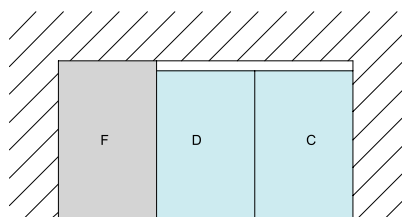

8

Izquierda
Left
Gauche

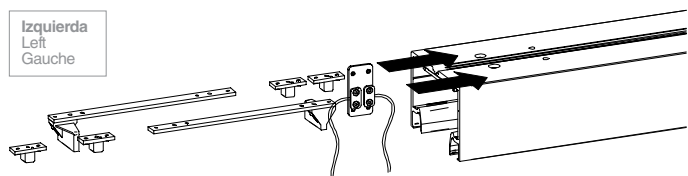

Sistema de montaje

Assembly system | Système de montage

SV - T-PRO X110

(MONTAJE PUERTAS | DOOR ASSEMBLY | INSTALLATION DES PORTES)

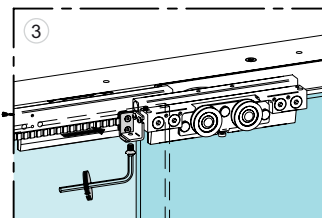
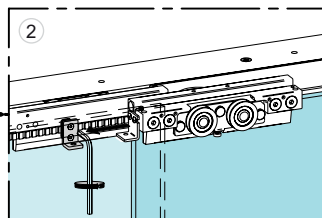
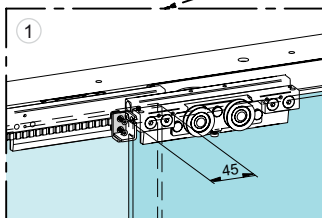
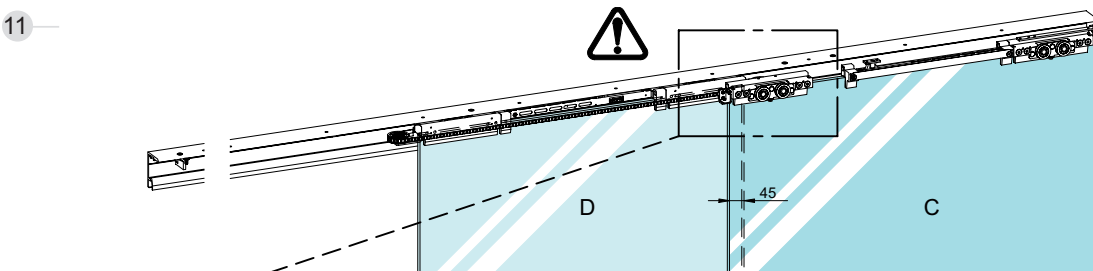
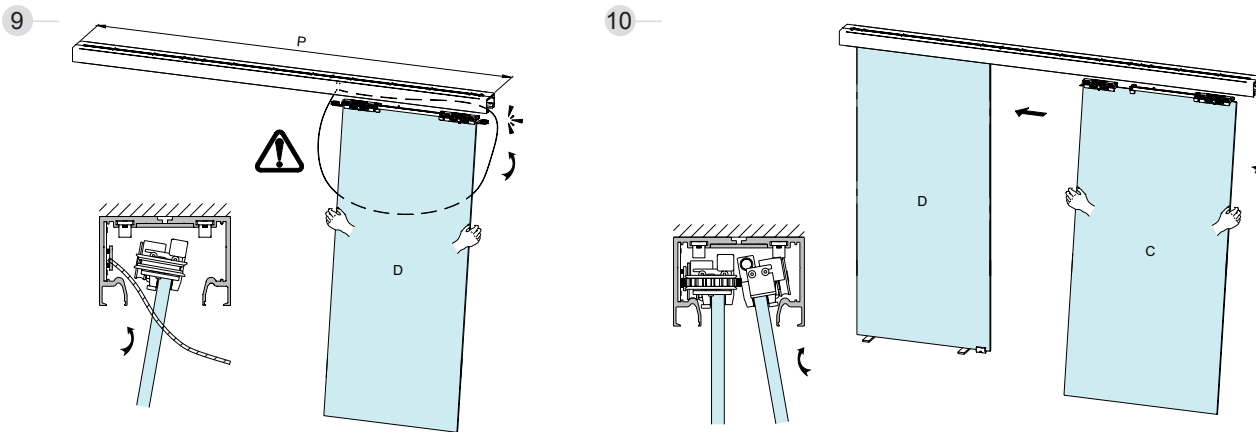

SV - T-PRO X110

(MONTAJE GUIADORES INFERIORES | LOWER GUIDERS MOUNTS |
 ASSEMBLAGE GUIDERS INFÉRIEURS)

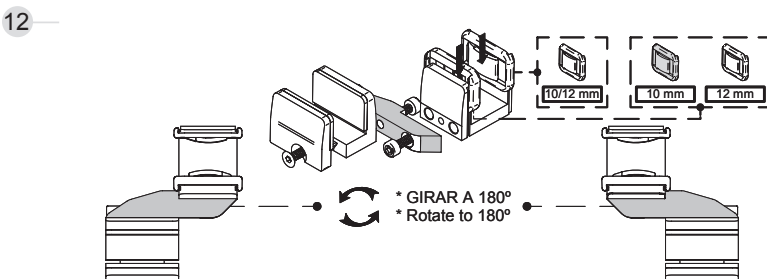





Guiador Izq. para vidrio 10/12mm
 Left guider for 10/12mm glass
 Guider gauche pour le verre 10/12mm

Guiador Dch. para vidrio 10/12mm
 Right guider for 10/12mm glass
 Guider droite pour le verre 10/12mm

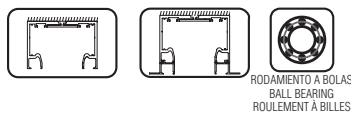
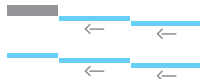
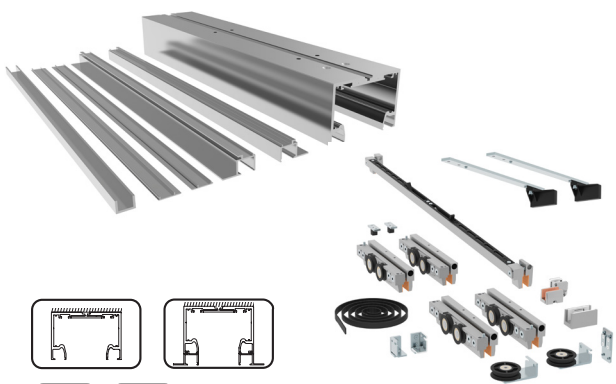

Composición Kits

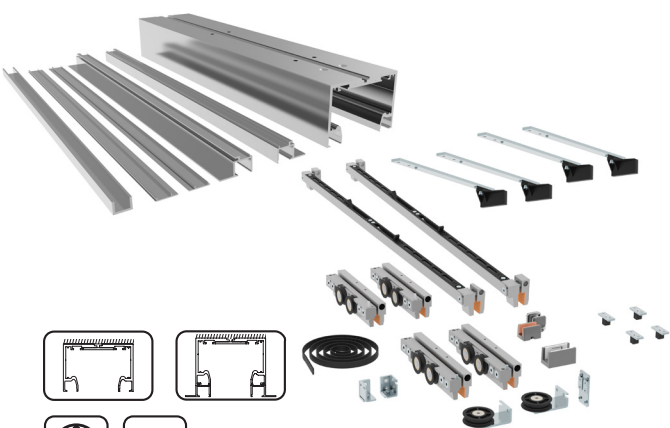
kits Composition | Composition de kits

KITS	Finished	Cód.			
  <p>RODAMIENTO A BOLAS BALL BEARING ROULEMENT À BILLES</p>	<p>Kit SV-T-PRO X110 con/sin vidrios fijos (10mm) Doble freno retenedor Instalación a techo o falso techo SV-T-PRO X110 kit with/without fixed glass (10mm) Double retaining brake Ceiling or false ceiling mount Kit SV-T-PRO X110 avec/sans verre fixe (10mm) 2 freins de retenue Fixation à plafond ou à faux plafond</p> <p>hasta 1 up to 1 jusqu'à 110 kg por hoja 1 per panel 1 par panneau</p> 	S	0 910 41	3 m	1 kit 1 jeu
		S	0 910 43	4 m	
		BS	0 910 42	3 m	
		BS	0 910 44	4 m	
  <p>RODAMIENTO A BOLAS BALL BEARING ROULEMENT À BILLES</p> <p>SOFTPRO</p>	<p>Kit SV-T-PRO X110 con/sin vidrios fijos (10mm) SOFTPRO doble 55kg Instalación a techo o falso techo SV-T-PRO X110 kit with/without fixed glass (10mm) double SOFTPRO 55kg Ceiling or false ceiling mount Kit SV-T-PRO X110 avec/sans verre fixe (10mm) SOFTPRO double 55kg Fixation à plafond ou à faux plafond</p> <p>hasta 1 up to 1 jusqu'à 55 kg por hoja 1 per panel 1 par panneau</p> 	S	0 910 45	3 m	1 kit 1 jeu
		S	0 910 47	4 m	
		BS	0 910 46	3 m	
		BS	0 910 48	4 m	
  <p>RODAMIENTO A BOLAS BALL BEARING ROULEMENT À BILLES</p> <p>SOFTPRO</p>	<p>Kit SV-T-PRO X110 con/sin vidrios fijos (10mm) SOFTPRO doble 110kg Instalación a techo o falso techo SV-T-PRO X110 kit with/without fixed glass (10mm) double SOFTPRO 110kg Ceiling or false ceiling mount Kit SV-T-PRO X110 avec/sans verre fixe (10mm) SOFTPRO double 110kg Fixation à plafond ou à faux plafond</p> <p>hasta 1 up to 1 jusqu'à 110 kg por hoja 1 per panel 1 par panneau</p> 	S	0 910 65	3 m	1 kit 1 jeu
		S	0 910 67	4 m	
		BS	0 910 66	3 m	
		BS	0 910 68	4 m	

hasta 1 up to 1 jusqu'à 110 kg |
242 lb por hoja 1 per panel 1 par panneau

SV-T-PRO X110

Multiplo Compact Glass

Aluminio anodizado plata mate
Satin anodized aluminum
Aluminium anodisé argent









Aluminio cepillado acabado Inox
Stainless steel brushed finish aluminium
Aluminium brossé finition inox

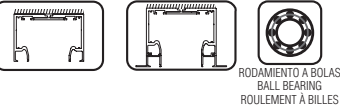

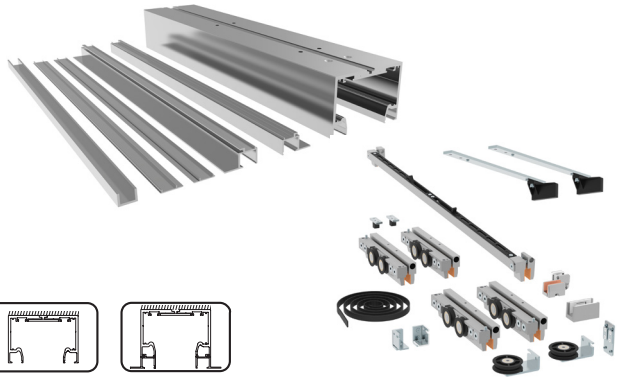
Composición Kits

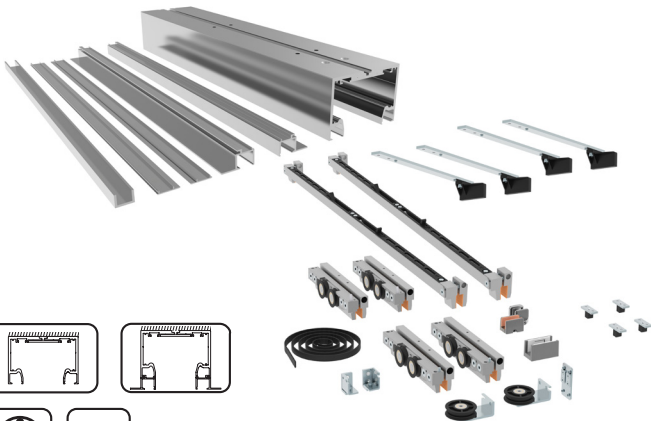
kits Composition | Composition de kits

KITS	Finished	Cód.		
 <p>Kit SV-T-PRO X110 con/sin vidrios fijos (12mm) Doble freno retenedor Instalación a techo o falso techo SV-T-PRO X110 kit with/without fixed glass (12mm) Double retaining brake Ceiling or false ceiling mount Kit SV-T-PRO X110 avec/sans verre fixe (12mm) 2 freins de retenue Fixation à plafond ou à faux plafond</p> <p>hasta 1 up to 1 jusqu'à 110 kg por hoja per panel par panneau</p>  <p>RODAMIENTO A BOLAS BALL BEARING ROULEMENT À BILLES</p> 	<p>S</p> <p>S</p> <p>BS</p> <p>BS</p>	<p>0 910 49</p> <p>0 910 51</p> <p>0 910 50</p> <p>0 910 52</p>	<p>3 m</p> <p>4 m</p> <p>3 m</p> <p>4 m</p>	<p>1 kit 1 jeu</p>
 <p>Kit SV-T-PRO X110 con/sin vidrios fijos (12mm) SOFTPRO doble 55kg Instalación a techo o falso techo SV-T-PRO X110 kit with/without fixed glass (12mm) double SOFTPRO 55kg Ceiling or false ceiling mount Kit SV-T-PRO X110 avec/sans verre fixe (12mm) SOFTPRO double 55kg Fixation à plafond ou à faux plafond</p> <p>hasta 1 up to 1 jusqu'à 55 kg por hoja per panel par panneau</p>  <p>RODAMIENTO A BOLAS BALL BEARING ROULEMENT À BILLES</p> 	<p>S</p> <p>S</p> <p>BS</p> <p>BS</p>	<p>0 910 53</p> <p>0 910 55</p> <p>0 910 54</p> <p>0 910 56</p>	<p>3 m</p> <p>4 m</p> <p>3 m</p> <p>4 m</p>	<p>1 kit 1 jeu</p>
 <p>Kit SV-T-PRO X110 con/sin vidrios fijos (12mm) SOFTPRO doble 110kg Instalación a techo o falso techo SV-T-PRO X110 kit with/without fixed glass (12mm) double SOFTPRO 110kg Ceiling or false ceiling mount Kit SV-T-PRO X110 avec/sans verre fixe (12mm) SOFTPRO double 110kg Fixation à plafond ou à faux plafond</p> <p>hasta 1 up to 1 jusqu'à 110 kg por hoja per panel par panneau</p>  <p>RODAMIENTO A BOLAS BALL BEARING ROULEMENT À BILLES</p> 	<p>S</p> <p>S</p> <p>BS</p> <p>BS</p>	<p>0 910 69</p> <p>0 910 71</p> <p>0 910 70</p> <p>0 910 72</p>	<p>3 m</p> <p>4 m</p> <p>3 m</p> <p>4 m</p>	<p>1 kit 1 jeu</p>



Componentes

Components | Composants

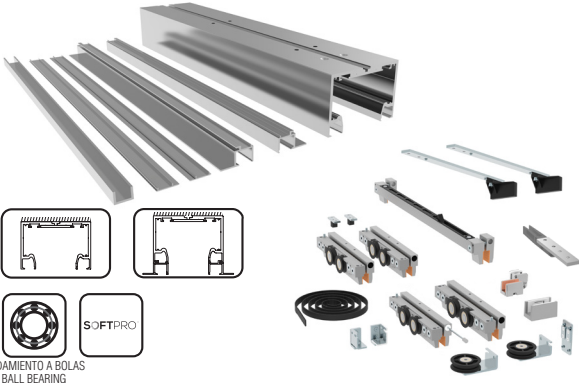
KITS		Finished	Cód.		
 <p>RODAMIENTO A BOLAS BALL BEARING ROULEMENT À BILLES</p> <p>SOFTPRO</p>	<p>Kit SV-T-PRO X110 con/sin vidrios fijos (10mm) SOFTPRO simple 55kg + 1 Anti-shock Instalación a techo o falso techo SV-T-PRO X110 kit with/without fixed glass (10mm) simple SOFTPRO 55kg + 1 Anti-shock Ceiling or false ceiling mount Kit SV-T-PRO X110 avec/sans verre fixe (10mm) SOFTPRO simple 55kg + 1 Anti-shock Fixation à plafond ou à faux plafond</p> <p>hasta 1 up to 1 jusqu'à 55 kg por hoja per panel par panneau</p>	<p>S</p> <p>S</p> <p>BS</p> <p>BS</p>	<p>0 109 50</p> <p>0 109 52</p> <p>0 109 51</p> <p>0 109 53</p>	<p>3 m</p> <p>4 m</p> <p>3 m</p> <p>4 m</p>	<p>1 kit 1 jeu</p>
	<p>Kit SV-T-PRO X110 con/sin vidrios fijos (10mm) SOFTPRO simple 110kg + 1 Anti-shock Instalación a techo o falso techo SV-T-PRO X110 kit with/without fixed glass (10mm) simple SOFTPRO 110kg + 1 Anti-shock Ceiling or false ceiling mount Kit SV-T-PRO X110 avec/sans verre fixe (10mm) SOFTPRO simple 110kg + 1 Anti-shock Fixation à plafond ou à faux plafond</p> <p>hasta 1 up to 1 jusqu'à 110 kg por hoja per panel par panneau</p>	<p>S</p> <p>S</p> <p>BS</p> <p>BS</p>	<p>0 109 58</p> <p>0 109 80</p> <p>0 109 59</p> <p>0 109 81</p>	<p>3 m</p> <p>4 m</p> <p>3 m</p> <p>4 m</p>	<p>1 kit 1 jeu</p>
	<p>Kit SV-T-PRO X110 con/sin vidrios fijos (12mm) SOFTPRO simple 55kg + 1 Anti-shock Instalación a techo o falso techo SV-T-PRO X110 kit with/without fixed glass (12mm) simple SOFTPRO 55kg + 1 Anti-shock Ceiling or false ceiling mount Kit SV-T-PRO X110 avec/sans verre fixe (12mm) SOFTPRO simple 55kg + 1 Anti-shock Fixation à plafond ou à faux plafond</p> <p>hasta 1 up to 1 jusqu'à 55 kg por hoja per panel par panneau</p>	<p>S</p> <p>S</p> <p>BS</p> <p>BS</p>	<p>0 109 54</p> <p>0 109 56</p> <p>0 109 55</p> <p>0 109 57</p>	<p>3 m</p> <p>4 m</p> <p>3 m</p> <p>4 m</p>	<p>1 kit 1 jeu</p>
	<p>Kit SV-T-PRO X110 con/sin vidrios fijos (12mm) SOFTPRO simple 110kg + 1 Anti-shock Instalación a techo o falso techo SV-T-PRO X110 kit with/without fixed glass (12mm) simple SOFTPRO 110kg + 1 Anti-shock Ceiling or false ceiling mount Kit SV-T-PRO X110 avec/sans verre fixe (12mm) SOFTPRO simple 110kg + 1 Anti-shock Fixation à plafond ou à faux plafond</p> <p>hasta 1 up to 1 jusqu'à 110 kg por hoja per panel par panneau</p>	<p>S</p> <p>S</p> <p>BS</p> <p>BS</p>	<p>0 109 82</p> <p>0 109 84</p> <p>0 109 83</p> <p>0 109 85</p>	<p>3 m</p> <p>4 m</p> <p>3 m</p> <p>4 m</p>	<p>1 kit 1 jeu</p>

Aluminio anodizado plata mate
Satin anodized aluminum
Aluminium anodisé argent



Aluminio cepillado acabado Inox
Stainless steel brushed finish aluminium
Aluminium brossé finition inox



hasta 1 up to 1 jusqu'à **110 kg** |
242 lb por hoja | per panel | par panneau

SV-T-PRO X110

Multiplo Compact Glass

Componentes







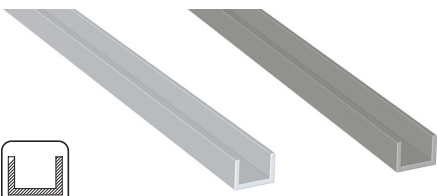

Components | Composants

CONJUNTOS DE PERFILES PROFILES SETS JEUX PROFILS		Finished	Cód.		
	<p>Conjunto perfil superior corredero para techo o falso techo con/sin vidrios fijos (10 mm) Top track set. Ceiling or false ceiling mount with/without fixed glass (10mm) Jeu rails de roulement pour fixation à plafond ou à faux plafond avec/sans verre fixe (10mm)</p>	S	0 109 38	3 m	1 juego 1 set 1 jeu
		S	0 109 48	4 m	
		S	0 109 68	6 m	
		BS	0 109 39	3 m	
		BS	0 109 49	4 m	
		BS	0 109 69	6 m	
	<p>Conjunto perfil superior corredero para techo o falso techo con/sin vidrios fijos (12 mm) Top track set. Ceiling or false ceiling mount with/without fixed glass (12mm) Jeu rails de roulement pour fixation à plafond ou à faux plafond avec/sans verre fixe (12mm)</p>	S	0 109 70	3 m	1 juego 1 set 1 jeu
		S	0 109 72	4 m	
		S	0 109 74	6 m	
		BS	0 109 71	3 m	
		BS	0 109 73	4 m	
		BS	0 109 75	6 m	
JUEGOS SETS JEUX		Finished	Cód.		
<p>RODAMIENTO A BOLAS BALL BEARING ROULEMENT À BILLES</p>	<p>Juego accesorios SV-T-PRO X110 Doble freno retenedor SV-T-PRO X110 fitting set with double retaining brake Garniture SV-T-PRO X110 avec 2 freins de retenue</p> <p>hasta 1 up to 1 jusqu'à 110 kg por hoja 1 per panel 1 par panneau</p>		0 109 12		1 juego 1 set 1 jeu
<p>RODAMIENTO A BOLAS BALL BEARING ROULEMENT À BILLES</p>	<p>Juego accesorios SV-T-PRO X110 SOFTPRO® doble 55kg SV-T-PRO X110 fitting set with double SOFTPRO® 55kg Garniture SV-T-PRO X110 avec SOFTPRO® double 55kg</p> <p>hasta 1 up to 1 jusqu'à 55 kg por hoja 1 per panel 1 par panneau</p>		0 109 09		1 juego 1 set 1 jeu
<p>RODAMIENTO A BOLAS BALL BEARING ROULEMENT À BILLES</p>	<p>Juego accesorios SV-T-PRO X110 SOFTPRO® doble 110kg SV-T-PRO X110 fitting set with double SOFTPRO® 110kg Garniture SV-T-PRO X110 avec SOFTPRO® double 110kg</p> <p>hasta 1 up to 1 jusqu'à 110 kg por hoja 1 per panel 1 par panneau</p>		0 109 13		1 juego 1 set 1 jeu
<p>RODAMIENTO A BOLAS BALL BEARING ROULEMENT À BILLES</p>	<p>Juego accesorios SV-T-PRO X110 SOFTPRO® simple 55kg + 1 Anti-shock SV-T-PRO X110 fitting set with simple SOFTPRO® 55kg + 1 Anti-shock Garniture SV-T-PRO X110 avec SOFTPRO® simple 55kg + 1 Anti-shock</p> <p>hasta 1 up to 1 jusqu'à 55 kg por hoja 1 per panel 1 par panneau</p>		0 109 16		1 juego 1 set 1 jeu
<p>RODAMIENTO A BOLAS BALL BEARING ROULEMENT À BILLES</p>	<p>Juego accesorios SV-T-PRO X110 SOFTPRO® simple 110kg + 1 Anti-shock SV-T-PRO X110 fitting set with simple SOFTPRO® 110kg + 1 Anti-shock Garniture SV-T-PRO X110 avec SOFTPRO® simple 110kg + 1 Anti-shock</p> <p>hasta 1 up to 1 jusqu'à 110 kg por hoja 1 per panel 1 par panneau</p>		0 109 17		1 juego 1 set 1 jeu

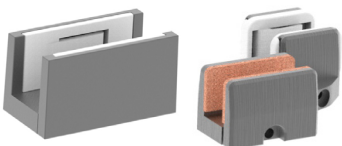

Componentes

Components | Composants

PERFIL INFERIOR LOW PROFILE PROFILE BAS		Finished	Cód.		
 	Perfil inferior para vidrio fijo Bottom U channel for fixed panel Rail bas pour verre fixe		00 87 34	3 m	1 perfil 1 profile 1 profil
			00 84 34		
ACCESORIOS ACCESSORIES ACCESSOIRES		Finished	Cód.		
	Juego guidores inferiores SV-T-PRO X110 SV-T-PRO X110 bottom guides set Jeu guides de sol SV-T-PRO X110		0 109 14		1 juego 1 set 1 jeu
			0 109 15		
	Junta transparente PVC 2mm PVC profile gasket 2mm Joint d'adaptation PVC 2mm		00 45 82	1 m	1 pieza 1 piece 1 pièce
	Junta transparente PVC 3mm PVC profile gasket 3mm Joint d'adaptation PVC 3mm		00 45 87	1 m	1 pieza 1 piece 1 pièce

hasta 1 up to 1 jusqu'à 110 kg |
242 lb por hoja | per panel | par panneau

SV-T-PRO X110

Multiplo Compact Glass

Aluminio anodizado plata mate
Satin anodized aluminum
Aluminium anodisé argent



Aluminio cepillado acabado Inox
Stainless steel brushed finish aluminium
Aluminium brossé finition inox



Multiplo Compact Glass

Polígono Industrial de Foradada / 08580
St. Quirze de Besora / Barcelona / Spain
T +34 93 852 92 23
F +34 93 852 91 59
saheco@saheco.com

Export contact details
T +34 93 852 96 15
F +34 93 855 13 42
export@saheco.com
saheco.com

+ info saheco.com

