

RGB CRITTER[®] FLASHLIGHT USER GUIDE

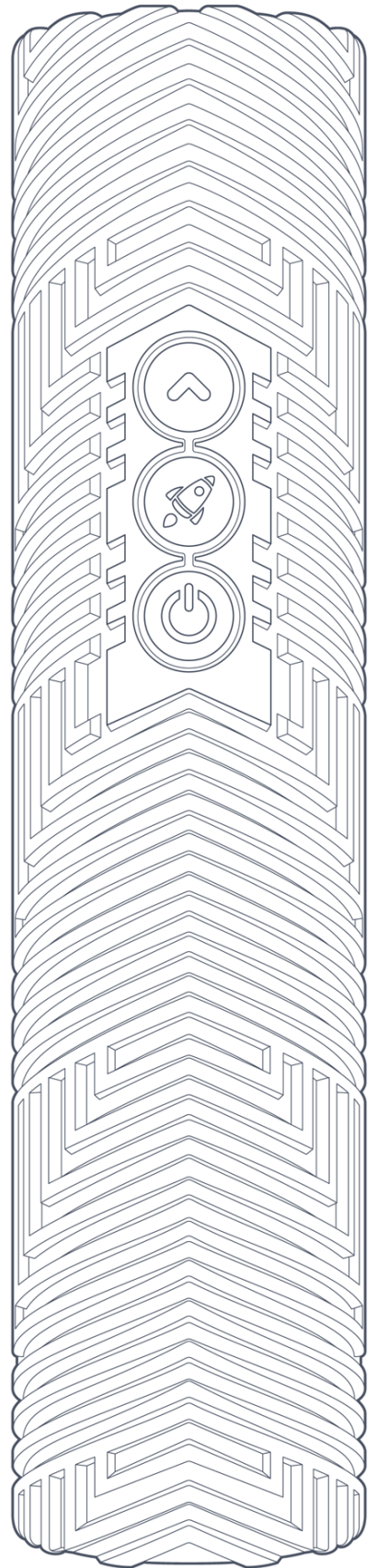

READ ME FIRST

SUPPORT

DON'T LIKE READING MANUALS? NO WORRIES!

There are many helpful product demo and tutorial videos that we created specifically for you! We highly recommend that you refer to these videos for instructions on how to use your RGB Critter and its many accessories: www.antsonamelon.com/pages/demo-videos.

For further assistance, please email us at support@antsonamelon.com.

INSTAGRAM

Need even more information? Check out our IGTV Section on Instagram for even more demos and tutorials.

[@antsonamelon](https://www.instagram.com/antsonamelon)

LEGAL

30-DAY SATISFACTION GUARANTEE

To ensure the highest quality for all customers, all Ants on a Melon, Inc. products are inspected before they leave our facilities in Oregon, USA. If you are not satisfied with any Ants on a Melon, Inc. product within 30 days of purchase, please return the product, complete with retail packaging and components along with the receipt, to the original place of purchase for a refund or replacement. Please note: your Ants on a Melon, Inc. product must be in 100% new condition to be eligible for a refund.

If you ordered your RGB Critter from www.antsonamelon.com, please fill out the form found on the website link below. We will contact you with additional instructions once we receive your return request.

www.antsonamelon.com/pages/return-policy

WARRANTY REGISTRATION

All orders placed on our website or on Kickstarter are automatically registered under warranty. If you would like to transfer the warranty to another person, this must be done within 30 days of receiving your order. To transfer your warranty, please contact us at support@antsonamelon.com. In the event of a Warranty Claim, we will use your order receipt and email address to verify your order information.

WARRANTY POLICY

See the entire Warranty Policy here: <https://antsonamelon.com/pages/warranty-info>.

CAUTIONS, DISCLAIMERS, AND WARNINGS

FIRST TIME USE

Examine box contents to ensure all included parts are in good condition, not damaged from shipping. Packaging materials, bags, and small parts may pose a choking hazard. Keep out of reach of children under the age of 14.

The information contained in this manual is an aid to understanding the various theories and practices, preparation, and uses, and it does not represent an endorsement or guarantee the efficacy or use of its preparation. Failure to read or follow instructions as well as improper or careless use may lead to personal injury. Ants on a Melon, Inc. and affiliated companies will not assume any liability for injury or damage resulting from the use or misuse of this device. Ants on a Melon, Inc. and affiliated companies are not liable for failures to comply with these warnings and safety guidelines. By purchasing the product, the buyer assumes all risks associated with lithium-ion batteries. If you do not agree with these conditions, return the product immediately before use.

LOCKED AND UNCHARGED

The RGB Critter was packaged with the buttons locked and a discharged battery. To unlock and charge your RGB Critter, please refer to the “Quick Start Instructions” included with your order.

CORRECT USE AND SAFETY

NOTICES

- **ALWAYS** have an accessory attached to the front end of the RGB Critter. Failure to do so could result in denting the RGB Critter aluminum housing.
- **ALWAYS** have the End Cap inserted into the back end of the RGB Critter. Failure to do so could result in denting the RGB Critter aluminum housing.
- **ALWAYS** wear proper eye protection when using our fiber optic products and Light Painting Blades.
- **ALWAYS** be aware of your surroundings while using our products. Maintain a safe distance around you when using our products in the presence of others.
- **DO NOT** remove the silicone sleeve when the RGB Critter is warm to the touch.
- **DO NOT** leave the unit turned on and left unattended.
- **DO NOT** attempt to recharge the batteries using any other methods not described in this manual.
- **DO NOT** use any other battery than the battery included with your RGB Critter Flashlight or other AOAM brand 18650 battery. Use of any other 18650 battery could result in damage to the RGB Critter or pose a danger to your safety.
- **DO NOT** charge your RGB Critter Flashlight with any micro-USB cable other than the one supplied with your order. Use of any other micro-USB cable could result in damage to the micro-USB port.

- **DO NOT** submerge the RGB Critter in water.
- **DO NOT** charge the RGB Critter outdoors.
- **DO NOT** hit the RGB Critter on hard surfaces such as concrete.
- **DO NOT** subject the RGB Critter to excessive force, shock, dust, temperature, or humidity.
- **DO NOT** disassemble the RGB Critter or tamper with internal components. Doing so will void any warranty.
- **DO NOT** expose the RGB Critter to direct sources of heat for extended periods of time.
- **DO** dispose of the unit legally and recycle when possible.

[DEMO VIDEO 1] GETTING STARTED: IMPORTANT NOTICES

This video discusses important information on how to correctly and safely use the RGB Critter.



ABOUT YOUR CRITTER

PACKAGE CONTENTS

- (1) RGB Critter® Flashlight
- (1) 18650 3.6V 3050mAh Lithium-Ion Battery
- (1) Micro-USB to USB 2.0 A-Male Charging Cable
- (1) Critter Key
- (2) Spare O-rings

RGB CRITTER® SPECS

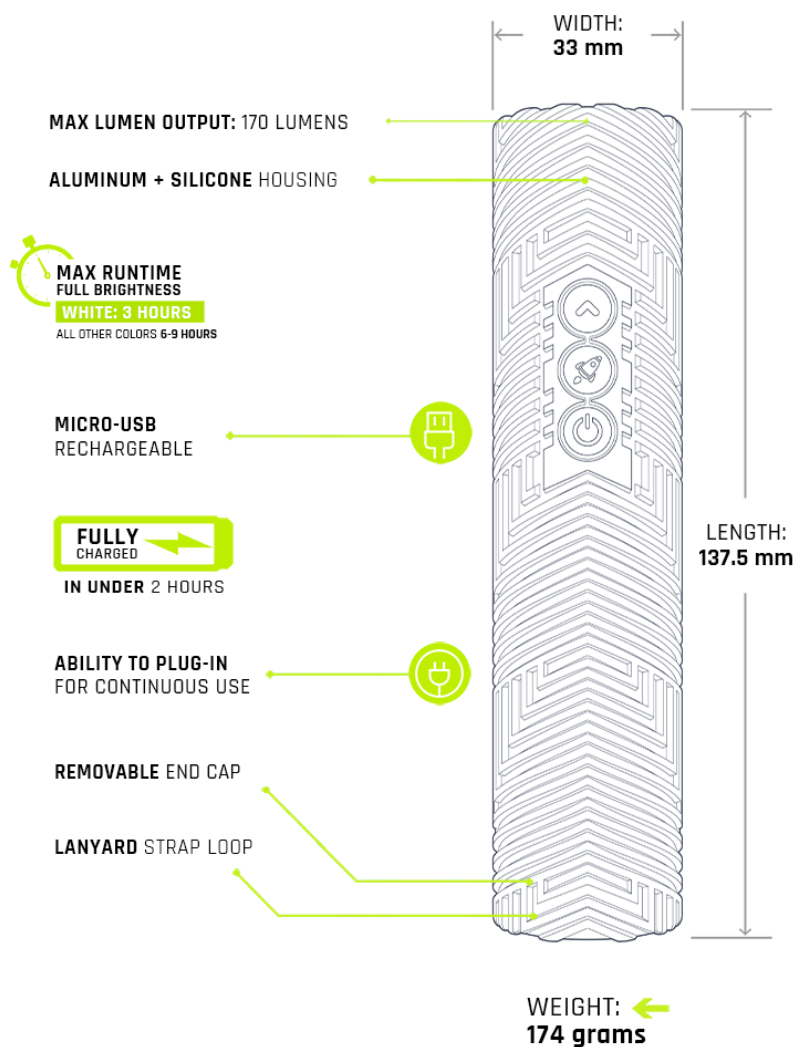

BATTERY SAFETY AND CHARGING

Ants on a Melon, Inc. batteries must meet rigorous standards. With normal use, they will last for hundreds of charge cycles without losing any capacity. The RGB Critter has built-in protection to prevent the battery from being overcharged or drained too low. To conserve battery life, use the RGB Critter in a temperature-controlled environment. When outdoors, stay sheltered from the elements and avoid using in extremely cold temperatures.

SAFETY DISCLAIMER

Ants on a Melon, Inc. batteries should not be substituted with third-party batteries. Only use official Ants on a Melon, Inc. branded batteries with your RGB Critter. We cannot verify the dimensions, quality, or safety of any other battery, and using third-party batteries can result in personal injury, electric shock, and damage to the RGB Critter which is not covered under warranty.

This flashlight will accumulate heat when used for extended periods, resulting in a high temperature for the flashlight shell. Pay attention to avoid burning.

ADDITIONAL BATTERY INFORMATION

If left within the RGB Critter, the 18650 battery will continue to discharge at a slow rate. If stored for more than 2-3 weeks, the battery should be removed from the RGB Critter and stored around the 50% charge level in a cool environment.

For a complete guide on battery safety and handling techniques and tips, head to:
www.antsonamelon.com/pages/battery-safety.

INSTRUCTIONS

[DEMO VIDEO 2] RGB CRITTER PARTS AND CHARGING

This demo video covers the physical features of the RGB Critter, important notices associated with these parts, and charging instructions.

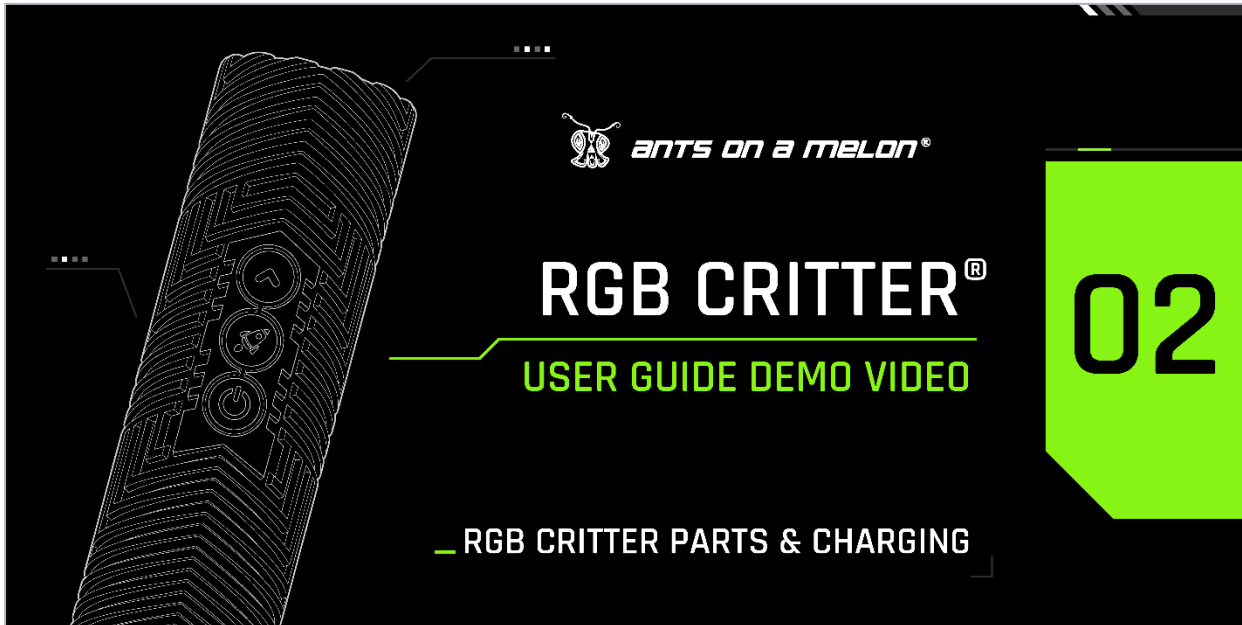

CHARGE VIA MICRO-USB PORT

1. Insert Critter Key into End Cap and rotate counterclockwise.
2. Insert micro-USB charging cable included with order. Plug other end of USB cable into the power source.

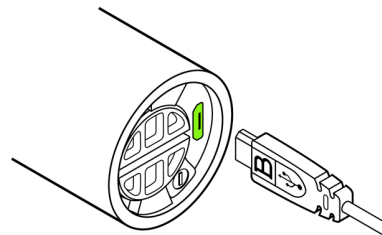
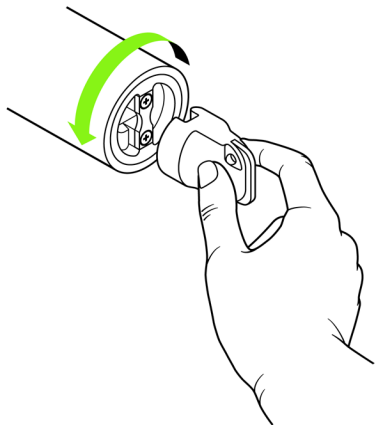

3. RGB Critter button LEDs will pulse to indicate the battery is charging.
4. RGB Critter button LEDs will blink 1x every 10 seconds when the battery is fully charged.
5. When the micro-USB cable is disconnected, the main LED will show corresponding color for battery charge level.

CHARGING RATES

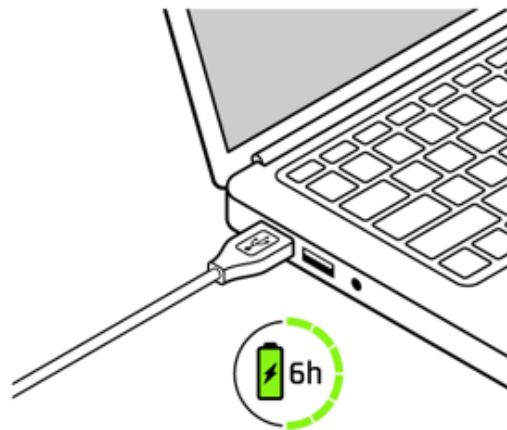
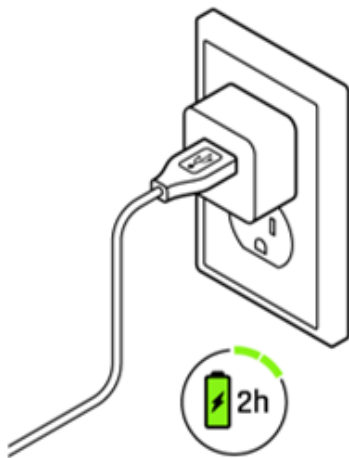

PLUG IN FOR CONTINUOUS USE

Using the micro-USB charging cable, you can power the RGB Critter for continuous use. With the micro-USB cable plugged in, the battery will fully charge then switch to direct power from your power source.

REPLACING 18650 BATTERY

1. Remove End Cap.
2. Insert metal side of Critter Key into Battery Cap and rotate counterclockwise.
3. The 18650 battery will slide out with the negative side facing outward.

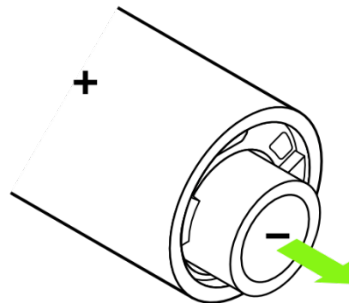
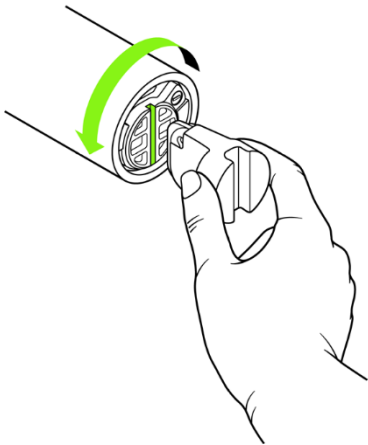

END CAP INSTALLATION

Always be sure to fully install the End Cap after charging or replacing a battery! Failure to do so may result in denting the RGB Critter's aluminum housing. It is intentional that the End Cap doesn't rest flush with the back side of the RGB Critter's aluminum housing. In other words, the End Cap will stick out a little way past the back end of the aluminum housing. This helps to prevent damage to this area in the event that the RGB Critter is accidentally dropped on a hard surface.

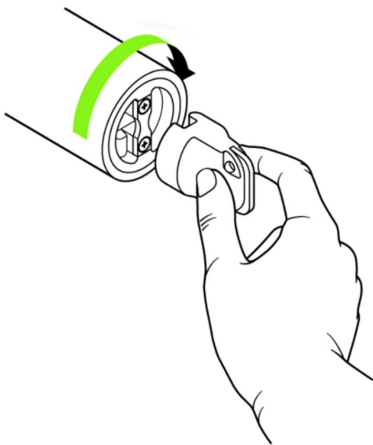

DEVICE CARE AND MAINTENANCE

STORAGE

Store the RGB Critter in a clean, dry environment and avoid direct exposure to sunlight.

PREVENT DENTING TO ALUMINUM HOUSING

To prevent denting on the front end of the RGB Critter, you should at all times have a twist-on accessory attached to the front end of the RGB Critter. Denting of the aluminum housing is NOT covered under warranty.

O-RINGS

The O-ring located on the End Cap of the RGB Critter is required to prevent water or dust ingress. If you notice that the O-ring on the End Cap is becoming worn or it has broken due to extended use, then replace it with one of the spare O-rings included with the RGB Critter Flashlight.

TROUBLESHOOTING

If you experience an issue with your RGB Critter Flashlight or any other Ants on a Melon, Inc. product, send an email to support@antsonamelon.com and we will assist you ASAP. To expedite your service request, please include a detailed description of the problem you're experiencing and include pictures if possible.

CERTIFICATIONS

All Ants on a Melon Products conform to the CE European Directives.



Disposal of Electrical & Electronic Equipment. The product should not be treated as household waste. Instead hand it over to the appropriate collection point for the recycling of electrical equipment which will conserve natural resources.

Disposal of waste batteries. This product contains batteries, do not dispose of them with other household waste. Hand them over to the appropriate collection point for recycling.

Ensuring proper product and battery disposal prevents potential negative consequences for the environment and human health. For more information, contact your city, your local household waste disposal service, the place of purchase or go to www.antsonamelon.com.

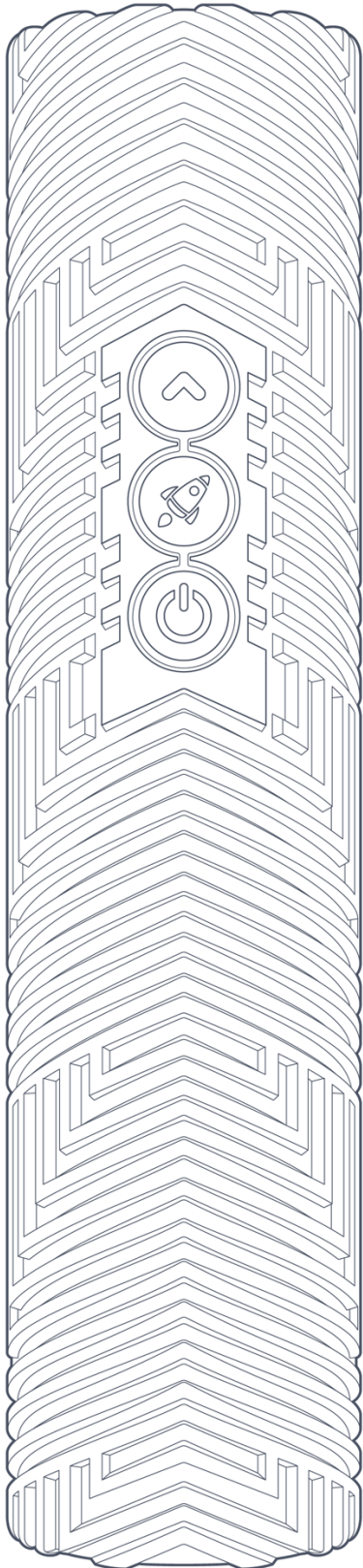

www.antsonamelon.com