

CASA1

HOUSEHOLD SLIDING DOOR

Installation manual



Contents

Product character	2
Application	2
Technical parameter	2
Spare part introduction	3-4
Installation	5
Application of mounting bracket	5
Rack selection	6-7
Installation of Mecahnism 1 (Use bracket)	8-12
Installation of Mecahnism2 (Top mounting)	13-16
Data adjustment	17-18
Setting of wireless push button	19
Terminal introduction	20
Trouble shooting and solution	20

Product character

- 1.Easy for instal,without change existing door structure.
- 2.Compact size,Nice appearance and modern design.
- 3.System can apply with sensor,remote control,push button, pet switch,photocell,card reader,lock and so on.
- 4.Window and door mode can be switched Arbitrarily.
5. 433.92hz module,can be suit with smart-home.

Application

- A. Door of kitchen and balcony.
- B. office, shop front and aisle.
- C.French window or other sliding window.

Technical parameter

Power supply	AC100-240V
MAX Weight	80kgs
MAX width	5Meter
Standard track	1Meter,Length can be Customized
Color	White/Black
Length of track	0.5Meter/pcs
Product weight	3.0kgs
Product measurement	490mm*72mm*63mm
Holding time	0-20s(Adjustable)

Spare part introduction

Cover



Drive unit



Rack



Wall mounting wireless push button



Power pack



End cap of Rack



Spare part introduction

Mounting bracket



Screw



3mm Allen key



Screw Driver



6key remote(optional)



wireless sensor (optional)



wired sensor (optional)



Install tools

Saw



Pistol Drill



Pencil



Installation

Top mounting1: System install on the top of window, Left window is moving part

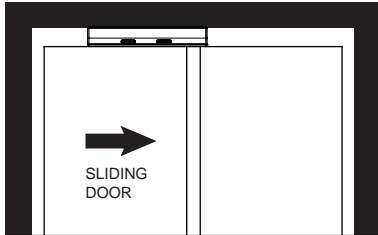

Top mounting 2: System install on the top of window, right window is moving part

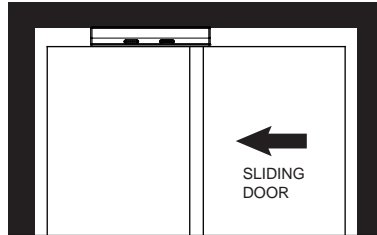

Bottom mounting1: System install at the bottom of window, left window is moving part

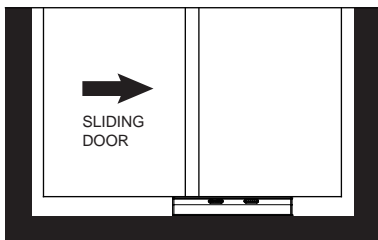

Bottom mounting2: System install at the bottom of window, right window is moving part

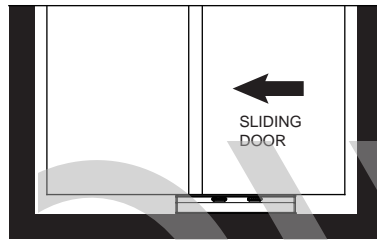

Application of mounting bracket

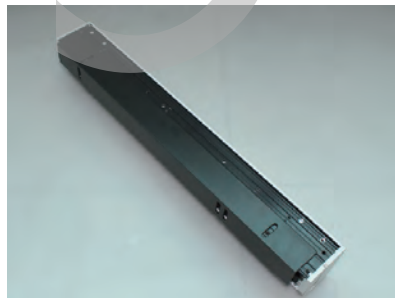

Rack selection

1. Put cap onto the rack of close direction

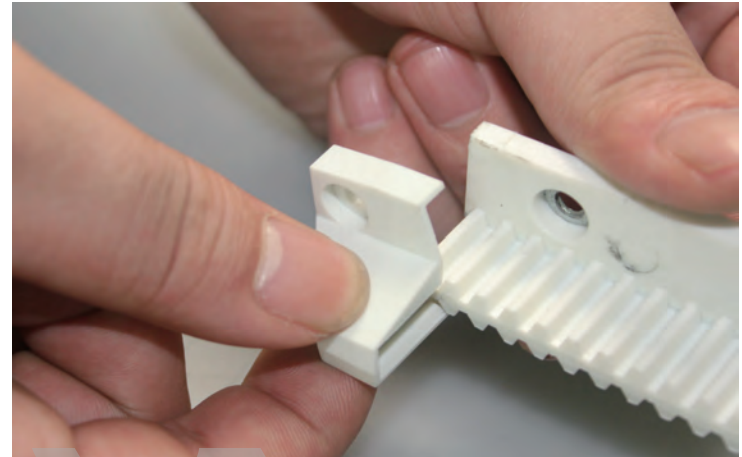

2. Connect 2 rack together when door/window width over 0.5m, Use hammer to make the connection part flat and straight,



Rack selection

3. Put the rack to the top or bottom of door and window edge, mark the width of width of door and window by pencil



4. Deduct 3 teeth and cut with saw (for end cap use) from the position marked in previous, (if not need end cap, cut with saw and not need to Deduct 3 teeth)

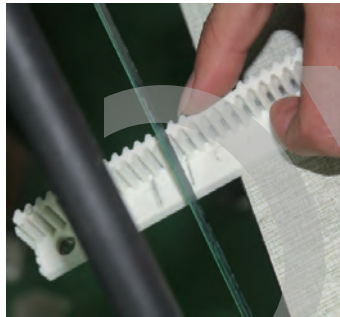

5. Cutted rack



Installation of Mecahnism 1 (Use bracket)

1. Put system to the top of door frame when door is fully closed, move the system about 70mm from the center line of whole door, mark the position of both side by pencil

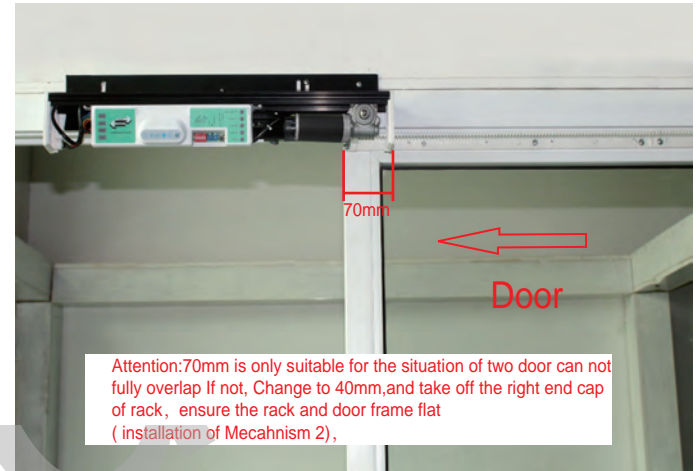

2. Adjust system position refer to the mark, leaving 25mm distance between system and door leaf, then tighten the screw

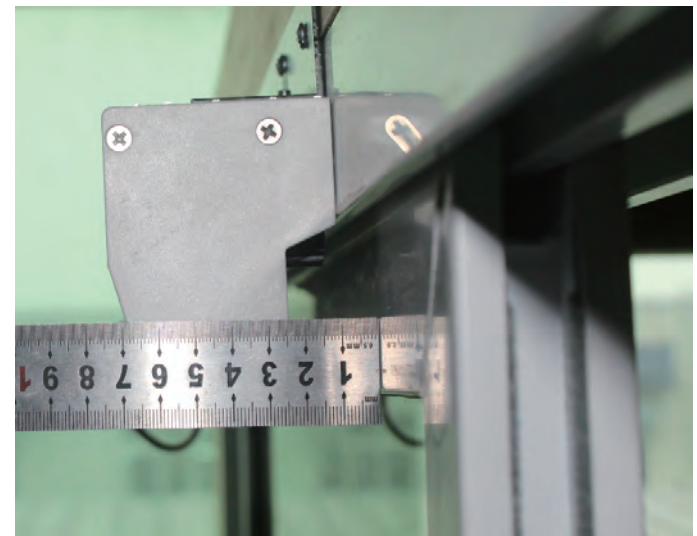

Installation of Mecahnism 1 (Use bracket)

3.Put the connected rack at another side, adjust the position and make the gear and rack is well fit, then tighten the screw

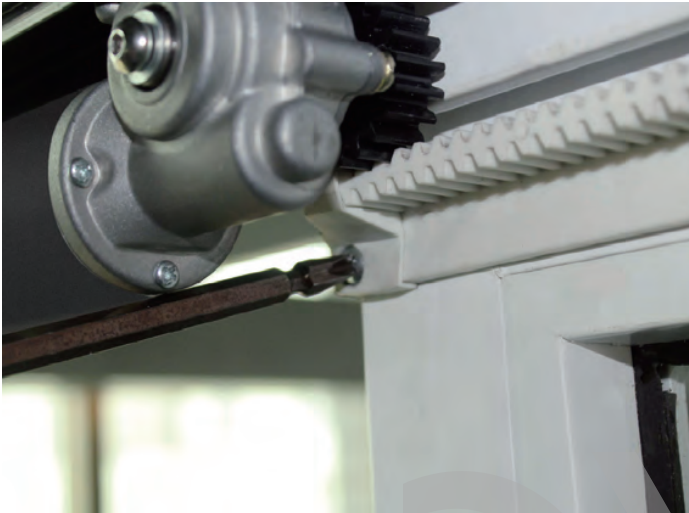

Installation of Mecahnism 1 (Use bracket)

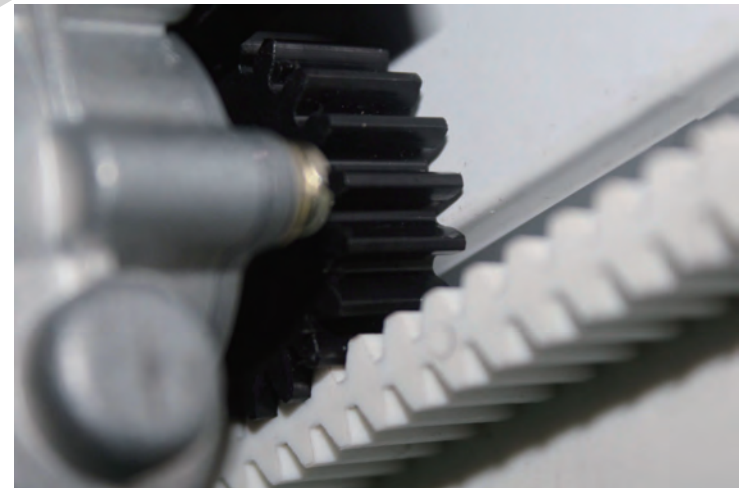
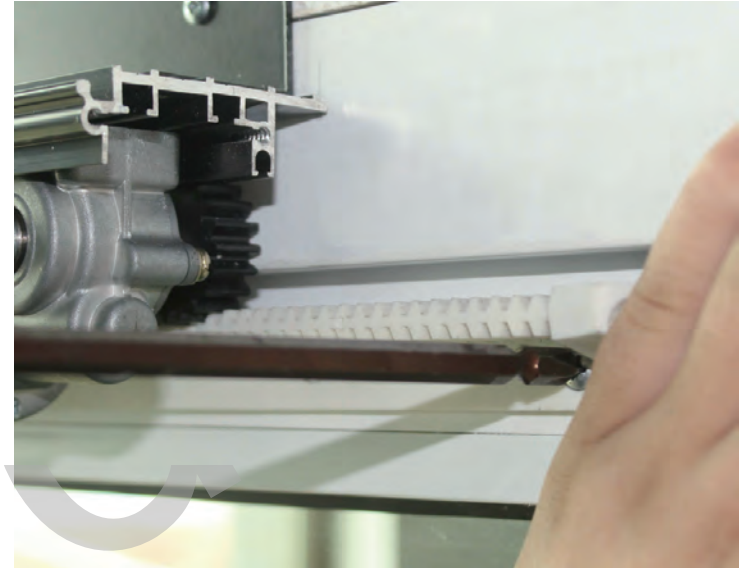

Installation of Mecahnism 1 (Use bracket)

4. Move the door leaf make sure that there is same resistance and try to reduce resistance as possible as it can be, Ensure the system smoothly working

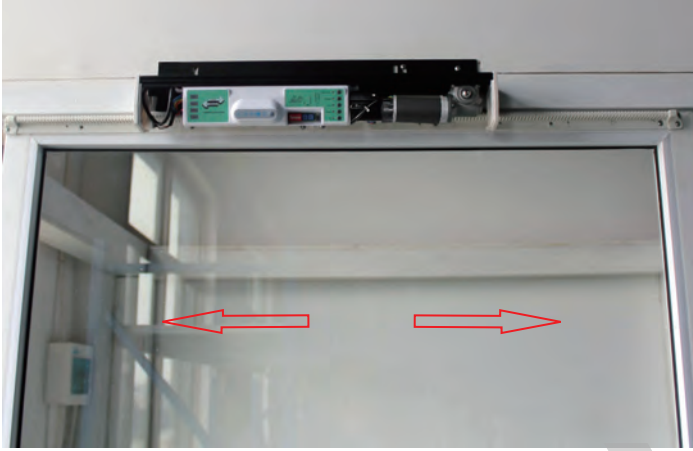

Installation of Mecahnism 1 (Use bracket)

6. Power on to test the system



5. Take out wireless push button, mounting onto the position as desire



7. Put on the cover after all test is done



Installation of Mecahnism 2 (Top mounting)

11. Put system to the top of door frame when door is fully closed, move the system right about 40mm from the center line of whole door, Mark the position of both side by pencil

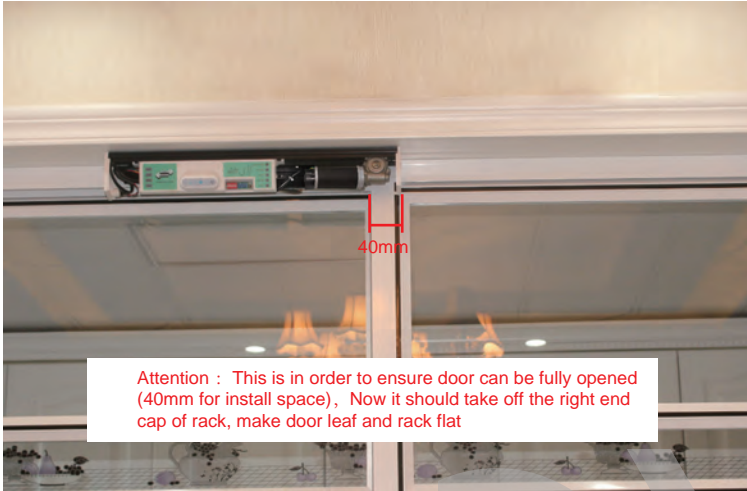

2. Adjust system position refer to the mark, leaving 25mm distance between system and door leaf, then tighten the screw



Installation of Mecahnism 2 (Top mounting)

3. Put the connected rack at another side, adjust the position and make the gear and rack is well fit, then tighten the screw

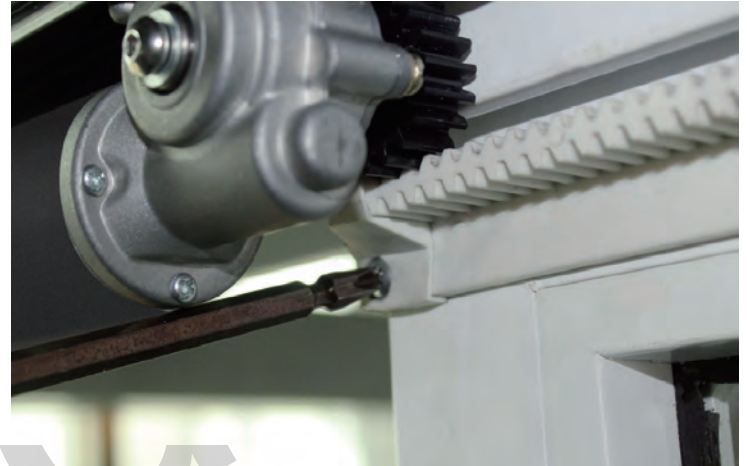

Installation of Mecahnism 2 (Top mounting)



Installation of Mecahnism 2 (Top mounting)

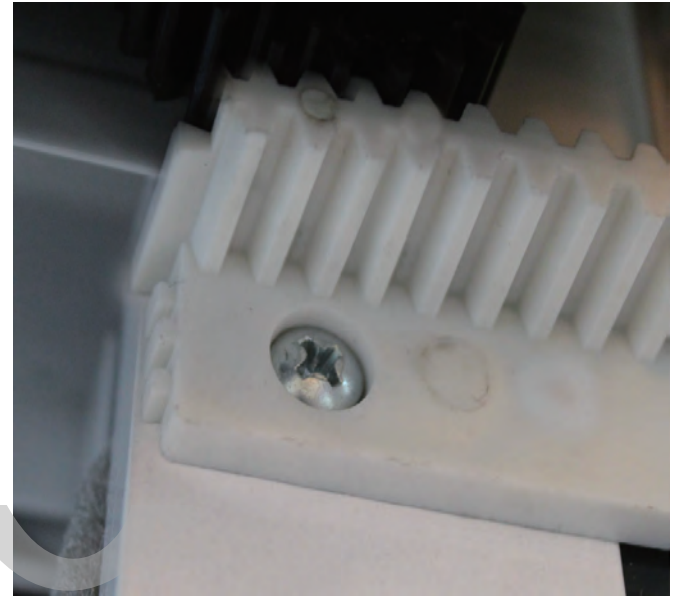

4. Power on and test, then put on cover



Data adjustment



Speed: adjustment of speed: open 10-41cm/S , Close 12-22cm/s

Slam mode: opening speed under 80%, open and close speed is same, opening speed higher than 80%, closing speed is half of opening

Without rubber: opening speed lower 50%, open and close speed is same, opening speed higher than 50%, closing speed is half of opening







Opening time: 0-20s (adjustable)

Learning button: Learning button of remote or wireless push button, added and delete remote process

Learning led: Remote learning indicator

There are five Mode available



-  Automatic: the door will open when a sensor is triggered and close after the preset dwell time has elapse (all signal working normal).
-  Hold open mode: the door will open and remain open until another mode is select
-  Lock mode: Door will close and remain closed until another mode is select by remote System will lock if there is a E-lock connect to it (In that mode, only remote signal is Available)
-  Pet mode: For use with pet sensors and when a pet opening width has been set (see below). Will open the door to the pet opening width when any pet sensor is triggered and close after the preset dwell time has elapsed;
-  manual model: the door can be manually operated, the system will not drive the door
-  Function select button

Data adjustment

DIP function intro duction and setting

DIP switch	On (upwards)	Off(downwards)
1.Direction L/R	ON – Left opening, OFF – Right opening. Toggle (back and forth) to erase memory and re-learn open/close cycle.	
2.Toggle mode	Activate to open activate to close	Normal mode
3. Beeper *	Beeper enabled	Beeper disable
4.Door/window	Window mode	Door mode
5.Lock mode	Automatic lock after full closed	Lock only with full lock signal
6.Slam shut	With rubber	Normal operation

DIP Swtich 1 and 4 must power off and restart can switch mode

*This dip switch can only turn off the voice of remote , If need turn off the voice of wireless push button,it should press learning button , then switch on or off

Window mode:

Pet mode to half open mode

Turn to close signal (A)

- Photocell *
- Inside *

Turn to open signal (B)

- Outside *
- Pet *

Active any terminal of A and B at same time, will work active to open or active to close (Attention: Must be one terminal from A and B active in same time)

Learning process:

Turn on the power switch,ensure dip 1 is correct, if direction is wrong, Please switch the dip to opposite direction, turn off the power and make sure door/window fully closed,Then power on

● Opening width learning (pet) :

Pet mode indicator flash,door will start to open slowly ,Put obstacle atthe position u need, after short pause, door will close slowly, the learning process will done after door/window fully close, standard opening width learning

● All mode indicator flash, door:

Will open and close slowly, when door is fully close and automatic mode indicator lighting, learning process is done, controller is with memory of opening width

Setting of wireless push button

Add:

1. Keep pressing the learning button LEARN, release the button a till LED become blue, then press any button on remote, remote will be added after led flash and buzzer rings
- 2.Keep pressing any button on remote, and keep pressing button LEARN on remote at same time, release button LEARN till LED become blue, remote will be added after led flash and buzzer rings

Delet:

Keep pressing learning button A 5 seconds, all remote memory will delete after LED flash 3 times

(Tip: Ensure keep pressing learning button when delet remote memory)

A

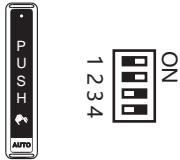

B(Optional)



Function selection of wireless push button (Work with sliding door)

- 1.Remove battery
- 2.Keep pressing "setting" button
- 3.Insert the battery at same time, the red led flash
- 4.Keep pressing Button B, Red led off about 5 second, then flash again
- 5 Release Setting button and B button, setting is done

Please check the DIP switch if its same as the image shown (during setting process)

Pw cut memory function:

All setting will be saved while power off, door will be close slowly after power on, then resume normal working (the working mode is same selection before power off); if need learning the opening width, power off, keep pressing function select button, then power on, release button after voice from controller, door will start learning turn

Mode of remote

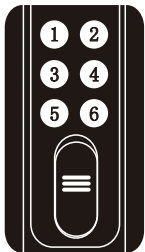

Door mode: 1 automatic 2 Hold open 3 Lock
4 Pet 5 manual 6 toggle

Terminal introduction

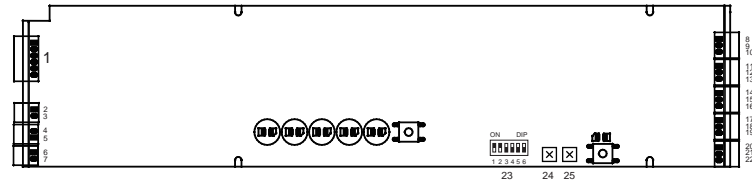

- | | | |
|------------------------------------|-------------------------------|----------------------------------|
| 1- Motor terminal | 10. GND | 19. GND |
| 2. DC24V+ | 11. Photocell signal terminal | 20. Pet signal terminal |
| 3. GND | 12. DC13V+ | 21. DC13V+ |
| 4. UPS+ | 13. GND | 22. GND |
| 5. UPS- | 14. Inside sensor | 23. Function select dip switch |
| 6. E-Lock- | 15. DC13V+ | 24. Open speed adjust knob |
| 7. E-Lock+ | 16. GND | 25. Opening time adjustment knob |
| 8. Function select signal terminal | 17. Outside sensor | |
| 9. DC13V+ | 18. DC13V+ | |

Trouble analysis and Solution

SYMPTOM	CAUSE	SOLUTION
Door does not open fully after learn cycle	Incomplete learn cycle	Remove the external cover (if already fitted). Turn the system off at the controller switch. Close the door manually. Keep press function selector button and turn on the switch of controller.after heard Voice bi, Test again after the learn cycle has completed. Refit external cover.
Door can not full lock, door Door can not full lock,door open again after close	Not well suit of gear and rack	Check and adjust the suit condition of gear and rack, turn off the switch of controller, close the door manually, restart the system, Test again after learn cycle has completed, Refit extrnal cover
Door can not not fully open and close	There is resistance between system and door	Turn DIP 6 to rubber mode
Door stop at the open or close process, full lock and pet indicators flash	There is resistance between system and door	Find the resistance item and remove it
Door open without any commander	Cause1: remote signal interference Cause2: sensor setting is too sensitive	Solution 1: open cover, delet all remote memory and setting again Solution 2: take off the cover of senor, adjust sensitive by knob
Door/window can not open	Door is lock by E-lock	U-lock the system

Connection with 504W RFID Controller

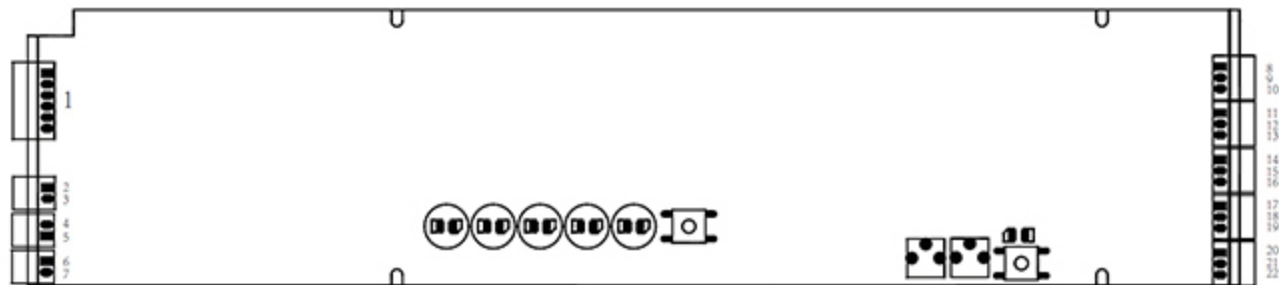

- 1、 Motor terminal
- 2、 DC24V+
- 3、 GND
- 4、 UPS+
- 5、 UPS-
- 6、 E-Lock-
- 7、 E-lock+
- 8、 Function select signal terminal
- 9、 DC13V+

- 10、 GND
- 11、 Photocell signal terminal
- 12、 DC13V+
- 13、 GND
- 14、 Inside sensor
- 15、 DC13V+
- 16、 GND
- 17、 Outside sensor
- 18、 DC13V+
- 19、 GND
- 20、 Pet signal terminal
- 21、 DC13V+
- 22、 GND
- 23、 Function select dip switch
- 24、 Open speed adjust knob
- 25、 Opening time adjustment knob

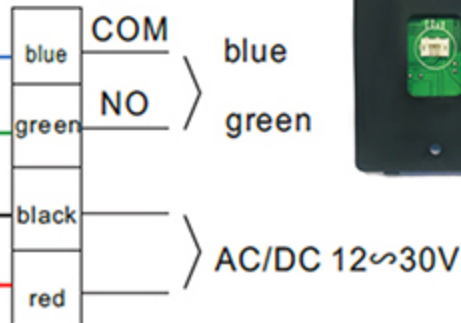

504W RFID controller



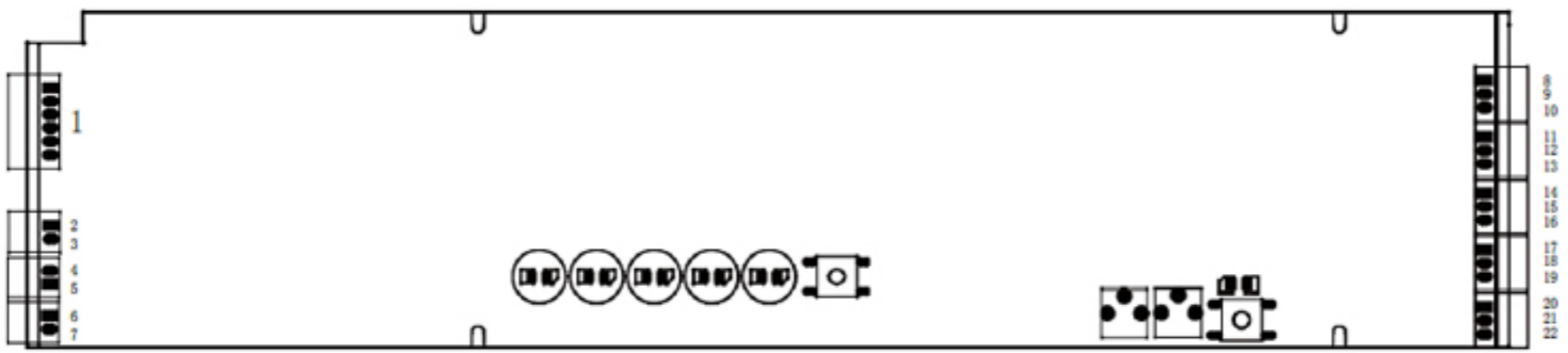

- 1、 Motor terminal
- 2、 DC24V+
- 3、 GND
- 4、 UPS+
- 5、 UPS-
- 6、 E-Lock-
- 7、 E-lock+
- 8、 Function select signal terminal
- 9、 DC13V+

- 10、 GND
- 11、 Photocell signal terminal
- 12、 DC13V+
- 13、 GND
- 14、 Inside sensor
- 15、 DC13V+
- 16、 GND
- 17、 Outside sensor
- 18、 DC13V+

- 19、 GND
- 20、 Pet signal terminal
- 21、 DC13V+
- 22、 GND
- 23、 Function select dip switch
- 24、 Open speed adjust knob
- 25、 Opening time adjustment knob

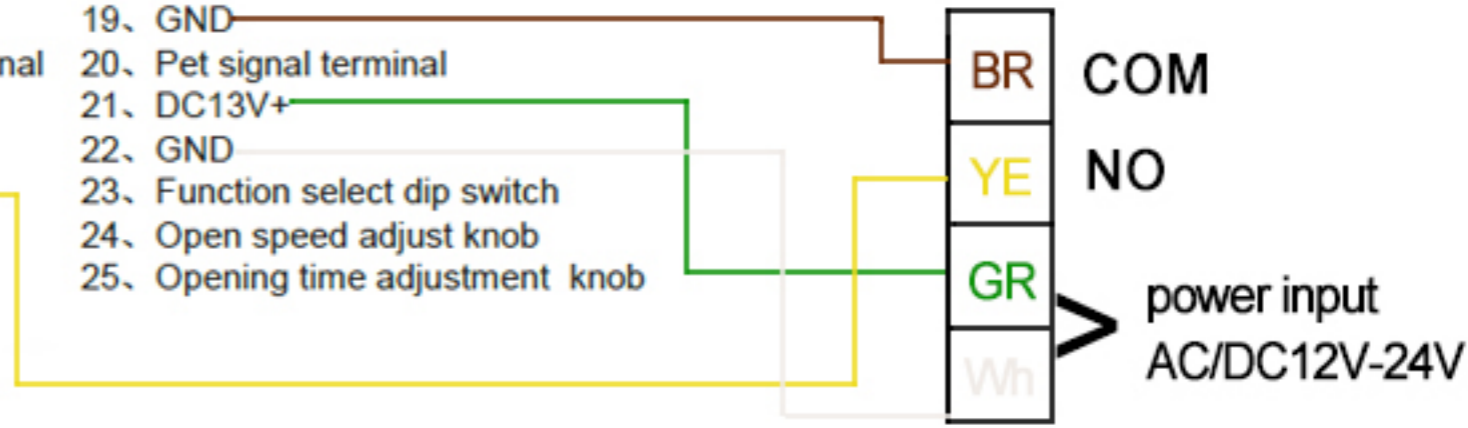

Connection of Microwave Sensor

Note: if you use it in outside, please wiring "NO" port to NO.17 "Outside sensor" port.



● Terminal introduction

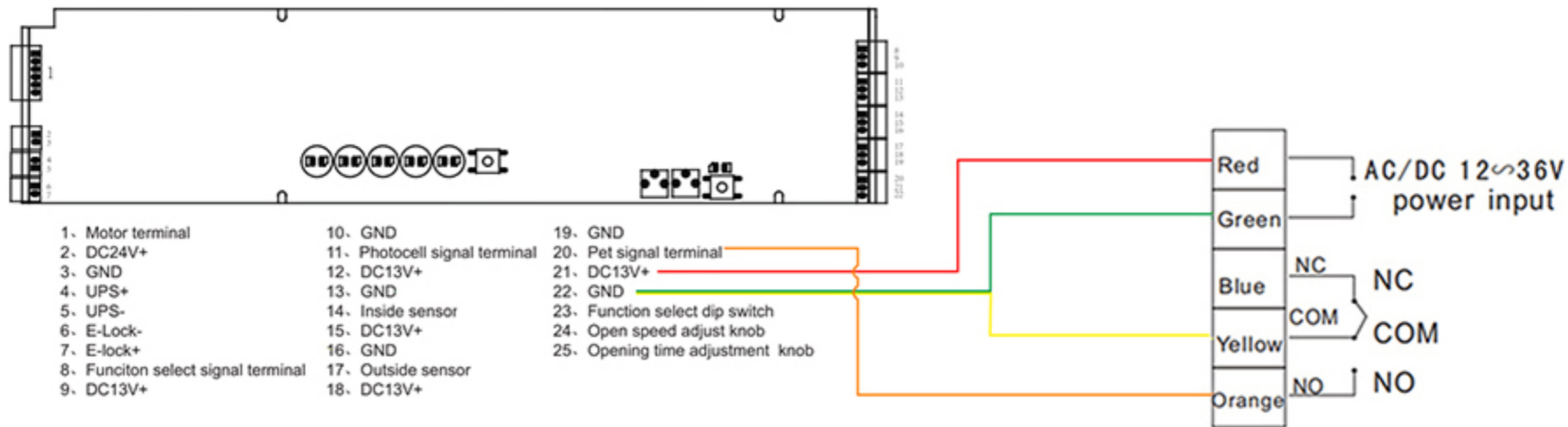

Connection with 237W Infrared Sensor



Connection with OS1001 WiFi Switch

Terminal introduction



- | | | |
|------------------------------------|-------------------------------|----------------------------------|
| 1. Motor terminal | 10. GND | 19. GND |
| 2. DC24V+ | 11. Photocell signal terminal | 20. Pet signal terminal |
| 3. GND | 12. DC13V+ | 21. DC13V+ |
| 4. UPS+ | 13. GND | 22. GND |
| 5. UPS- | 14. Inside sensor | 23. Function select dip switch |
| 6. E-Lock- | 15. DC13V+ | 24. Open speed adjust knob |
| 7. E-lock+ | 16. GND | 25. Opening time adjustment knob |
| 8. Function select signal terminal | 17. Outside sensor | |
| 9. DC13V+ | 18. DC13V+ | |

