

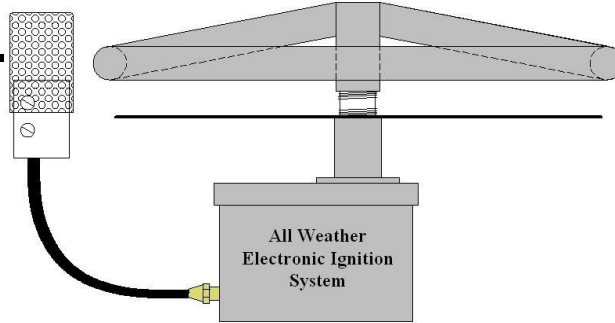

www.FirebyDesign.com

All Weather Electronic Ignition  
Field Serviceable (24 VAC)  
Commercial Grade System  
**Owner's Manual**  
Installation and Operation



Certified by  
Lab Test Certification  
Meets: ANSI Z21.97-2014  
CSA 2.41-2014  
CSA C22.2 No. 3-M1998 (R2014)

**⚠ WARNING ⚠**

Improper installation, adjustment, alteration, service or maintenance can cause injury or property damage. Read the installation, operating and maintenance instructions thoroughly before installing or servicing this equipment.

**⚠ WARNING ⚠**

Do not store or use gasoline or other flammable vapors and liquids in vicinity of this or any other appliance.

An LP-cylinder not connected for use shall not be stored in the vicinity of this or any other appliance.

**⚠ WARNING ⚠**

**FOR OUTDOOR  
USE ONLY**

**⚠ DANGER**



**CARBON MONOXIDE HAZARD**

This appliance can produce carbon monoxide which has no odor.

Using it in an enclosed space can kill you.

Never use this appliance in an enclosed space such as a camper, tent car or home.

**⚠ WARNING ⚠**

For Use with NATURAL or LP GAS Only

**NO SOLID FUELS TO BE USED WITH THIS SYSTEM**

**⚠ DANGER ⚠**

If you smell gas:

1. Shut off gas to the appliance.
2. Extinguish any open flame.
3. If odor continues, keep away from appliance and immediately call your gas supplier or fire department.

Installation must conform with local codes or, in the absence of local codes, with the *National Fuel Gas Code, ANSI Z223.1 / NFPA 54, or International Fuel Gas Code.*

The appliance, when installed, must be electrically grounded in accordance with local codes or, in the absence of local codes, with the *National Electric Code, ANSI/NFPA 70*, if applicable.

**INSTALLER:** Leave this manual with the appliance.  
**CONSUMER:** Retain this manual for future reference.

**⚠ AVERTISSEMENT ⚠**

Une installation, un ajustement, une modification, une réparation ou un entretien inapproprié peuvent être la cause de blessures ou de dommages. Veuillez lire attentivement les instructions d'installation, d'utilisation et d'entretien avant d'installer ou de réparer ce matériel.

**⚠ AVERTISSEMENT ⚠**

Ne pas entreposer ni utiliser de l'essence ni d'autres vapeurs ou liquides inflammables dans le voisinage de l'appareil, ni de tout autre appareil.

Une bouteille de propane qui n'est pas raccordée en vue de son utilisation, ne doit pas être entreposée dans le voisinage de cet appareil ou de tout autre appareil.

**⚠ AVERTISSEMENT ⚠**

Pour utilisation  
à l'extérieur seulement.

**⚠ DANGER**



**MONOXYDE DE CARBONE**  
Cet appareil peut produire du monoxyde de carbone, un gaz inodore.

L'utilisation de cet appareil dans des espaces clos peut entraîner la mort.

Ne jamais utiliser cet appareil dans un espace clos comme un véhicule de camping, une tente, une automobile ou une maison.

**⚠ AVERTISSEMENT ⚠**

Pour utilisation avec naturel ou propane ne gaz seulement  
Aucun combustibles solides pour être utilisés avec ce système

**⚠ DANGER ⚠**

S'il y a une odeur de gaz:

1. Coupez l'admission de gaz de l'appareil.
2. Éteindre toute flamme nue.
3. Si l'odeur persiste, éloignez-vous de l'appareil et appelez immédiatement le fournisseur de gaz ou le service d'incendie.

**⚠ AVERTISSEMENT ⚠**

Ne pas utiliser cet appareil s'il a été plongé, même partiellement, dans l'eau. Appeler un technicien qualifié pour inspecter l'appareil et remplacer toute partie du système de commande et toute commande qui a été plongée dans l'eau.

## **Table of Contents**

Gas and Electrical Requirements	Page 4
Daisy Chain Wiring Requirement	Page 4
Clearance from Combustibles	Page 5
Installation	Page 5
Acceptable Media for Fire Features	Page 8
Installation of Media in Fire Features	Page 8
Operation	Page 9
Maintenance	Page 10
Replacement Parts	Page 11
Troubleshooting	Page 11
Attachment 1: Automated Pool Controller Wiring Illustration	Page 12

### Gas Requirements

Fuel Type – Before making gas connections ensure appliance being installed is compatible with the available gas type. Check the label on the appliance to confirm appliance gas type requirement.

Gas Pressure – Proper input gas pressures are required for optimum appliance performance.

### **Gas Pressure Requirements**

<b>Pressure</b>	<b>Natural Gas</b>	<b>Propane</b>
Minimum	3.5” W.C. / 1/8 psi	8.0” W.C. / 1/3 psi
Nominal	7.0” W.C. / ¼ psi	11.0” W.C. / 1/3 psi
Maximum	14.0” W.C. / ½ psi	14.0” W.C. / ½ psi

### Electrical Requirements

#### **▲ WARNING ▲**

The All Weather Electronic Ignition System operates on 24 Volts AC power ONLY  
(Check labeling on AWEIS to ensure the required voltage is 24 VAC)

**DO NOT Attempt to Power using 110 Volts AC Power – Damage WILL RESULT**

### **Recommended Wire Size**

12-gauge wire for all installations

### Daisy Chain Wiring of Multiple AWEIS

The Fire by Design 24 Volt AC AWEIS has a Blue and Yellow wire protruding from it. These are the power wires.

When daisy chaining multiple AWEIS the polarity between the AWEIS MUST be the same.

To achieve this all the Blue wires must be connected to the same wire from the power supply and all the Yellow wires connected to the other wire from the power supply as shown in this illustration.

**NO MORE THAN 4 AWEIS ARE TO BE DAISY CHAINED TOGETHER**

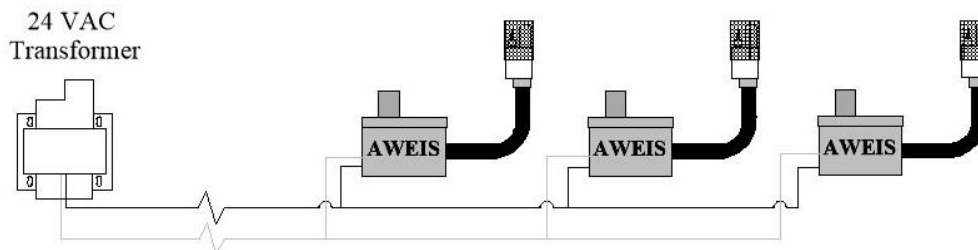

**Clearance from Combustibles**  
**▲ WARNING – FIRE RISK ▲**

Provide Adequate Clearance from Combustibles as shown below

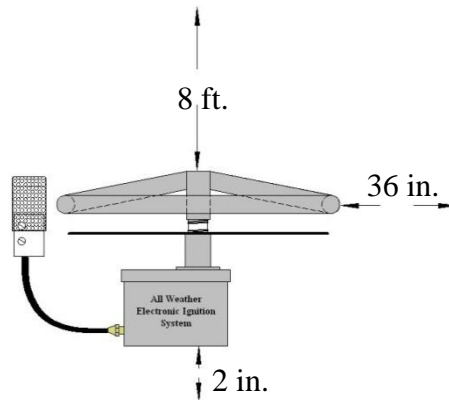

**Installation**

**Note: Installation should be done by a qualified service technician that is locally licensed.**

1. In the photo at right there is a bowl with both a gas riser and an electrical conduit stubbed up inside the bowl. It is preferred to stub the gas riser centered in order to ensure the fire ring is centered in the bowl once installation is complete.

**NOTE:** Drainage **MUST** be provided in the bowl. Drainage can be obtained by making holes in the bottom or sides of the bowl as shown.

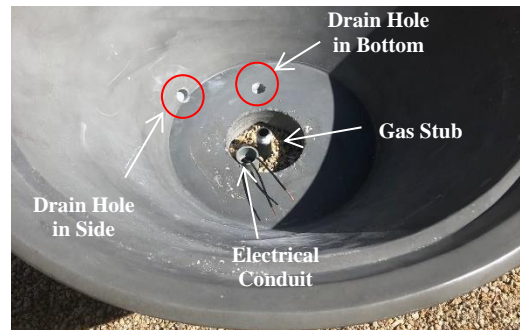

2. Apply pipe dope/tape to the gas stub and thread the AWEIS Ignition Control Box onto the gas riser as shown in the photo at right.

**NOTE:** Leak Test – it is highly recommended to perform a gas leak test at this point in the install. Turn on the gas supply and then, using a soapy water solution spray the bottom of the AWEIS where it is connected to the gas line to ensure no leaks exist.

3. Electrical Connections. In the photo at right the wires protruding from the AWEIS have been connected to the two wires from the electrical conduit using appropriate sized wire nuts.

**NOTE:** It is not required but it is recommended to fill the wire nuts with either dielectric grease or silicone prior to installing the wire nut. This will ensure a weatherproof electrical connection.



4. On the side of the AWEIS Ignition Control Box there are two brass fittings and two white electrical “Molex” connectors for the Pilot Burner Assembly. The brass fitting on the left is a ¼” Compression fitting and the one on the right is a ¼” Flare fitting. The Pilot Burner has two gas lines; one that ends in a Compression fitting and one that ends in a ¼” Flare Nut. When installing the Pilot Burner ensure you connect the gas lines to the matching fittings on the side of the box. There are two different styles of Molex connectors as well. When plugging into the Molex connectors make sure your are plugging into the correct shaped connector.



The photo at right shows the AWEIS after the Pilot Burner Assembly has been connected. Notice the Brass Compression Fitting on the left and the Brass Flare Nut on the right.



Note: With every fire feature an orifice MUST be installed between the outlet of the AWEIS Ignition Control Box and the burner. When the fuel type is Natural Gas a Natural Gas Orifice is to be installed. When the fuel type is Propane a LP Air Mixer Orifice is to be installed. The noticeable difference between these two orifices are the 6 Air Holes in the LP Air Mixer orifice. To ensure proper operation of the LP Air Mixer Orifice it must be configured with a coupling and a pipe nipple as shown in far-right photo. The Natural Gas orifice can be installed without a coupling and pipe nipple.

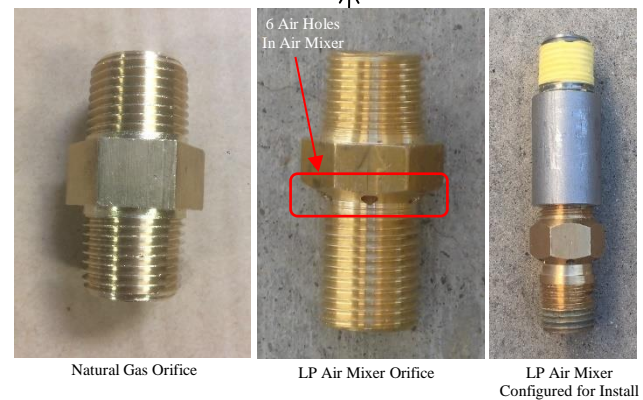

5. The photo at right shows what the AWEIS looks like just prior to installing the burner pan

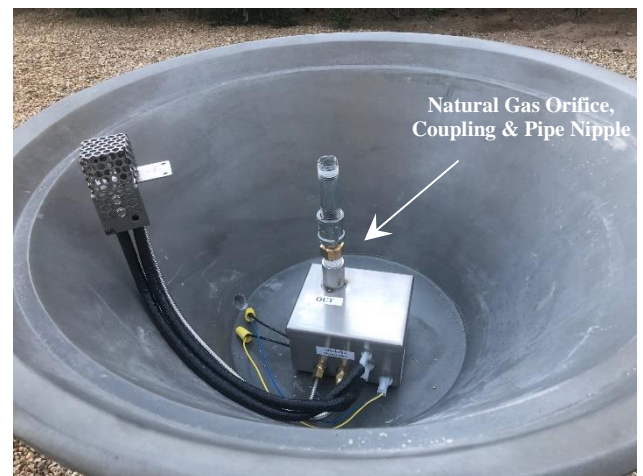



6. Install the Burner Pan. You will need to line up the Opening for the Pilot Burner with the Pilot Burner. You will notice that the hole in the center of the pan (for the pipe nipple coming from the Ignition Control Box) and the opening for the Pilot Burner are much larger than needed. This is done to make it easier to Install the Burner Pan. The large gaps around the pipe nipple and Pilot Burner will be covered with additional parts sent with the Burner Pan in Step 8 below.

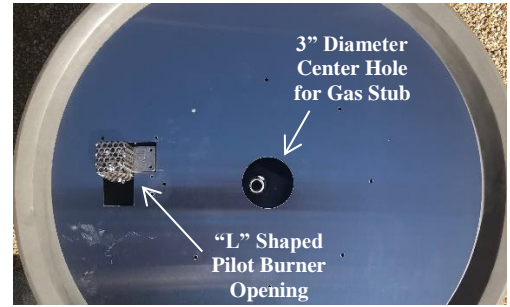

7. At right you see two cover plates that should have been sent with the burner pan along with 4 stainless steel screws. In the next step the Pilot Burner is secured to the pan and these cover plates are then installed to cover the openings in the pan to prevent media from falling down below the pan.

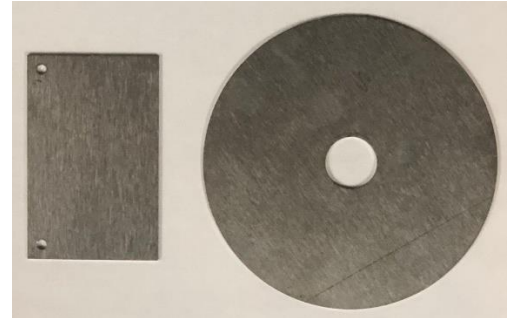

8. At right you see the Pilot Burner secured to the pan using 2 of the stainless steel screws. In addition the rectangle shaped cover plate is also secured to the pan using 2 stainless steel screws. The donut shaped cover plate is placed over the gas stub and is not secured to the pan but held in place by gravity.



9. Install the burner onto the pipe nipple coming up through the center of the pan as shown in the photo at right.



The final step is to add media to the fire feature which will be discussed on the following page.

### Acceptable Media for Fire Features

#### ⚠ WARNING ⚠

Do not use any other material as filler/topping media inside fire features other than those listed below. Using improper media inside a fire feature could result in damage to property or injury to persons nearby due to media ‘popping’ or ‘exploding’ due to heat

#### List of Acceptable Media for Fire Features

Lava Rock (or other Igneous Rock) NO LARGER THAN 2” in diameter

Fireglass approved for use in fire features

Manmade stone for use in fire features (Refractory Material)

#### Installation Note

The use of media inside fire features is recommended due to the fact it enhances the look of the fire feature but also improves its performance by forcing the gas emanating from the burner to mix as it passes through the media. This ‘mixing’ of gases creates an even flame throughout the feature and helps spread the flame from the Pilot Burner throughout the burner quicker than when there is no media. **Recommended thickness of the media above the burner element is NO MORE than 2”**. Due to the fact the Pilot Burner must be partially exposed to oxygen in order to ignite the pilot flame during startup **DO NOT COMPLETELY COVER THE PILOT BURNER**. When installation of the media is complete the top of the Pilot Burner Protective Cover should be visible.

#### Installation of Media in Fire Features

##### **Lava Rock**

At right there are two pictures of the fire bowl after adding lava rock. The size lava rock used in this feature is 2” in diameter.

The picture on the far right is a close up of the Pilot Burner. Notice it is barely visible in either of the photos.

When using smaller lava rock you may not be able to cover it as well due to the fact the smaller rock may “smother” the Pilot Burner and prevent oxygen from getting to it.



##### **Fireglass**

At right there are two pictures of the fire bowl after adding fireglass. The size fireglass used in this feature is 1/2” in diameter.

The picture on the far right is a close up of the Pilot Burner. Notice it is barely visible in either of the photos.

When using smaller fireglass you may not be able to cover it as well due to the fact the smaller rock may “smother” the Pilot Burner and prevent oxygen from getting to it.





## Illustrations showing Completed Installations

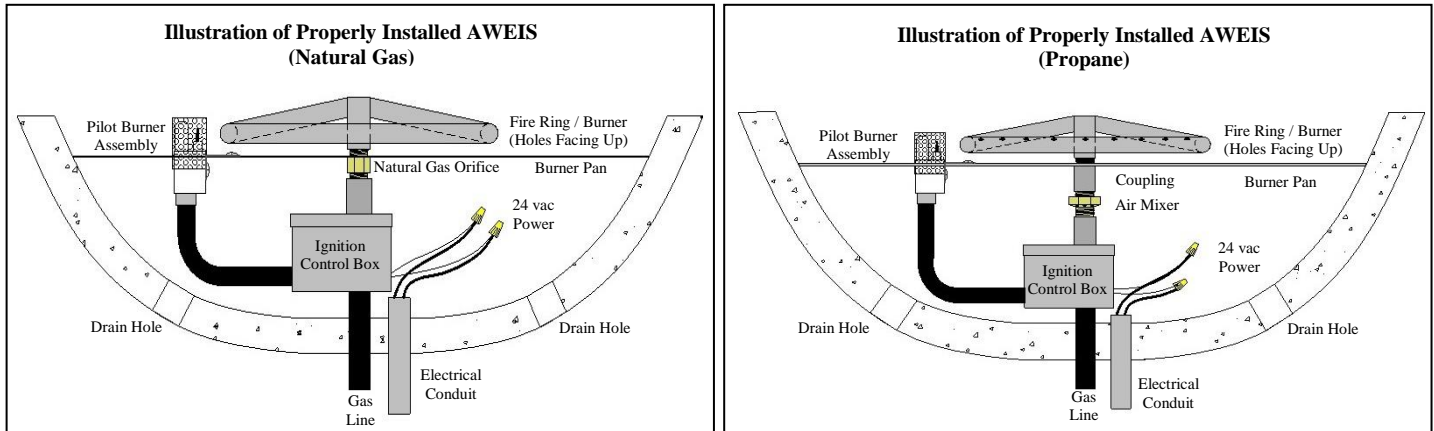

### Operation

#### ⚠ WARNING ⚠

Do NOT use this appliance if any part has been under water. Immediately call a qualified service technician to inspect the appliance and to replace any part of the control system and any gas control which has been under water.

#### ⚠ WARNING ⚠

**HOT – DO NOT TOUCH - SEVERE BURNS MAY RESULT - CLOTHING IGNITION MAY RESULT**

- CAREFULLY SUPERVISE children in same area as the appliance.
- Alert children and adults to hazards of high temperatures.
- Clothing or other flammable materials should not be hung from the appliance or placed on or near the appliance.

#### ⚠ WARNING ⚠

The appliance should be inspected before use and at least annually by a qualified service technician.

Any guard or protective device removed for servicing must be replaced prior to operation.

Keep the appliance area clear and free from combustible materials, gasoline and other flammable vapors and liquids.

### Fire Feature Start Up

1. Prior to turning appliance on visually inspect fire feature to ensure debris such as leaves or other combustible material has not collected inside the feature which could burn and emit embers once the fire feature is turned on. Also ensure any person standing close to the fire feature is aware you will be turning the fire feature on prior to actually turning it on.

2. Turn fire feature on by turning on the electrical device used to power the fire feature.

Sequence of Operation during Ignition

- Power is applied
- Hot Surface Igniter (Glow Plug) becomes hot and 4 seconds later the Pilot Gas Valve opens
- Within 10 seconds of power application Pilot Flame should be visible (at night only)
- Within 10 seconds of Pilot Flame Ignition burner (fire ring/burner bar) should ignite

**Fire Feature Shutdown**

1. Turn fire feature off by turning off the electrical device used to power the fire feature.

**▲ WARNING ▲**

If fire feature fails to turn off completely (small flames still visible)  
Turn off gas supply using the manual gas shutoff.

**Maintenance**

**▲ WARNING ▲**

Maintenance should be done by a qualified service technician.  
The appliance should be inspected before use and at least annually by a qualified service technician.

**▲ WARNING ▲**

Ensure gas and power are shut off and appliance is cool before servicing.

**▲ WARNING ▲**

Any guard or protective device removed for servicing must be replaced prior to operation.

**Prior to Each Use**

1. Inspect for debris in Fire Feature – remove debris prior to use

**Semi-Annually**

1. Visually inspect Pilot Burner for debris/insect infestation (spider webs)
2. Visually inspect burner holes for debris/insect infestation
3. Clean either of the above as necessary using compressed air.

**Annually**

1. Visually inspect Pilot Burner for excess corrosion due to heat and moisture.
2. Turn fire feature on to ensure proper operation.

## Replacement Parts

Item Letter	Part Name	Part #
A	Pilot Burner Assembly	PBA
B	Ignition Control Box	ICB
C	24 VAC Transformer	24VAC
D	Secondary Pilot Burner Gas Line	SPBG
E	Primary Pilot Burner Gas Line	PPBG
F	Pilot Burner Orifice	PBO
G	Pilot Burner Cage	PBC
H	PBA Thermopile	TP
J	PBA Hot Surface Igniter	HSI

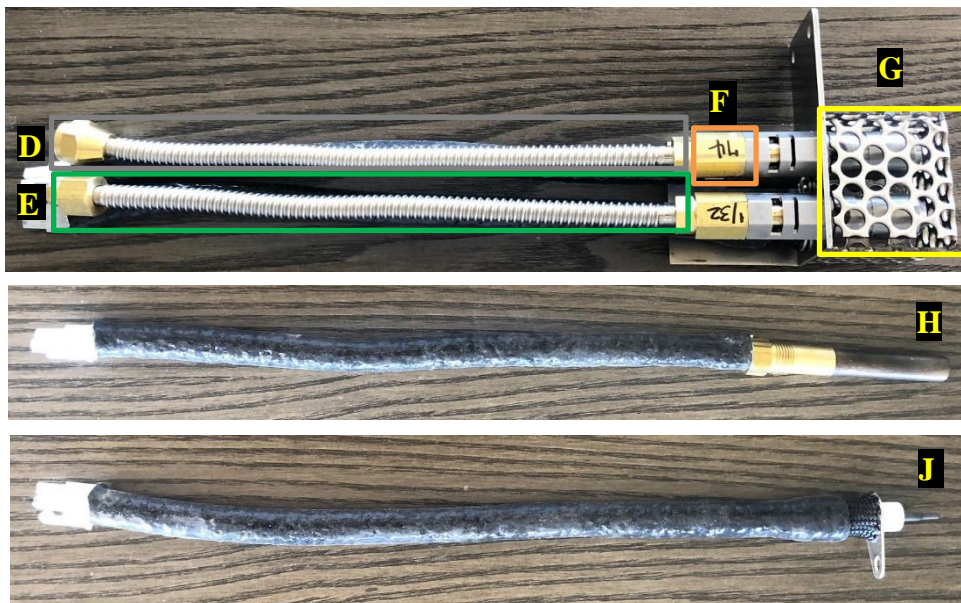
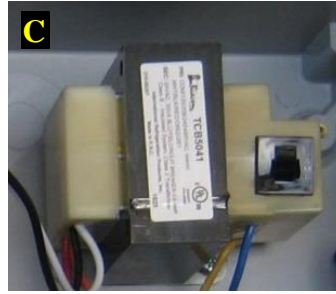
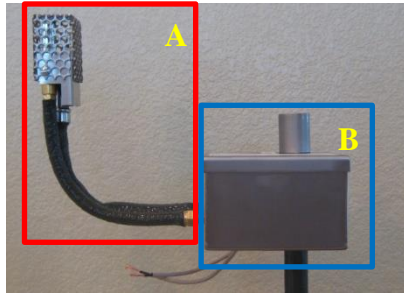

## Troubleshooting

See Troubleshooting Guide at this link:

<http://www.firebydesign.com/text/AWEIS-Troubleshooting-Guide.pdf>

Attachment 1

Automated Pool Controller Wiring

**Wiring to Pool Controller when 2 Features Turned ON at same time**

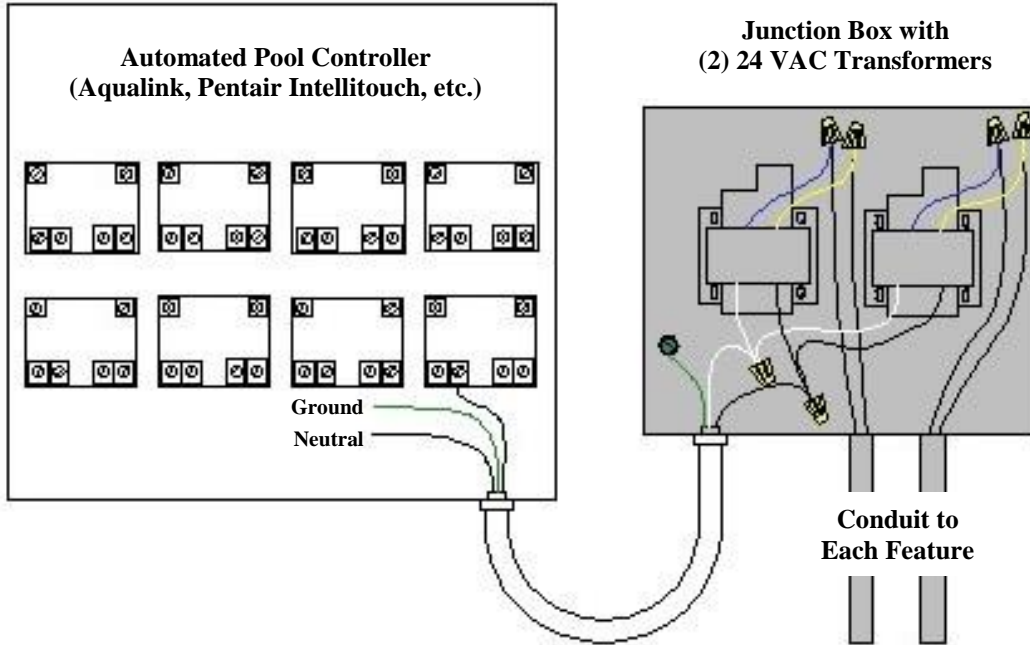

**Wiring to Pool Controller when 2 Features Turned ON separately**

