



THE OUTDOOR PLUS

USA MANUFACTURER OF FIRE & WATER FEATURES



THEOUTDOORPLUS.COM — 909.460.5579

PROFESSIONAL IS THE WORD THAT DESCRIBES THE OUTDOOR PLUS.

We have over 25 years of Professional experience designing, building and installing fire pits, fire tables, BBQ islands, entertainment islands, unique one of kind fire and water displays and other backyard features. From our President to the Head of Manufacturing to the Director of Sales and Marketing, we have all made a career of helping home owners bring their vision of the perfect backyard entertainment experience come into reality.

Our products are the best, our people are the best, our customers are always satisfied and our prices can't be beat. Contact us today for the name of your local dealer so we can begin turning your backyard into something unbelievable!

THE OUTDOOR PLUS PHOTOGRAPHY PROGRAM

Here at **THE OUTDOOR PLUS** we are always looking for the best images and photography that represents our products and the lifestyle around it.

Finished an installation that uses our products that you are proud of? Send us your images! *Most DSLR cameras or high end smart phones will work! (Samsung Galaxy S6 or newer. iPhone 6 or newer)*

Images requirements:

Must be high resolution.
Larger than 1000 x 1000 pixels.
Minimum 200 PPI.



Not sure if your photos meet these requirements?

Send them to us and our in-house media director will advise you. If your images are approved, you will receive \$100 - \$150 credit for any future purchases.

Send Pictures with: Your name, company name, phone number, Purchase Order # or Sales Order # to SALES@THEOUTDOORPLUS.COM

Help us promote your work with our amazing products. We look forward to your submissions



TABLE OF CONTENTS

Bullet Burners	4
Bullet Burners & Pan Kits	6
Stainless Steel Flat Pans & Burners	12
Stainless Steel Drop In Pans & Burners	16
Stainless Steel Burners	20
Ornaments & Sculptures	24
Water Over Fire Kits	30
Ready To Finish Fire Pit Forms	31
Firepit Lids	33
Accessories & Gas Kits	34
Electronic Ignition Kits	39
Burning Media	42
Warranty & Terms	44

Scuppers	70
Self Contained Units	72
Torches	76
Fire Towers	78
Corten Steel Planters	80
Wood Grain GFRC Fire Pits	82
Wood Grain GFRC Seating	85
Smooth GFRC Fire Pits	87
Metal Fire Tables	99
Fire Pit Add-Ons	108
Electronic Ignition Systems	109
Accessories	110
Burn Media Selection	111
Flame Guards and Fire Pit Covers	112
Custom Fire and Water Units	114
Utility Line Diagrams	116
Clearance From Combustibles	117
Warranty and Return Policy	118
Map Policy	118

TOP FIRES CATALOG

Concrete Bowls	49
Copper Bowls	60
Powder-coated Bowls	66
Ornaments	68



PATENTED BULLET BURNERS

[Click to Return to Table of Contents](#)



Our Patented Bullet Burner is the perfect addition to any pre-existing fire pit. It can easily replace any standard burner and provide you with a taller, fuller flame while consuming less gas.

Limited Lifetime Warranty on All Brass Bullet Burners 5 Year Warranty on All Stainless Steel Bullet Burners

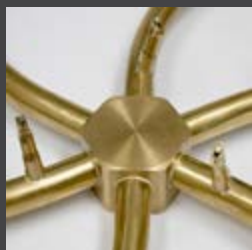

Uniform Gas Flow Generator

Our Patented Hub Distributes Gas Evenly Throughout The Burner

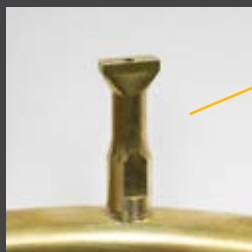

BULLET ORIFICE FLAME SPREADER

Precision Machined Components

Gives You Consistent Quality & Durability That You Can Rely On

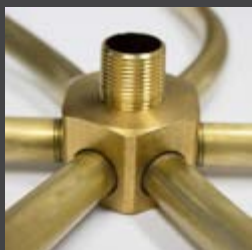

Flat Flame Technology

Our Patented Bullet Orifice Compresses Gas Flow And Incorporates Oxygen To Create A Cleaner Flame

Individually Assembled

Quality Control To Provide You With A Great Product Every Single Time



IMPORT BURNER



PATENTED BULLET BURNER

PATENTED BULLET BURNERS - BRASS OR STAINLESS STEEL

The Patented Bullet Burner's eliminate the need for an additional air mixer. Suitable for either natural gas or liquid propane applications. Manufactured with high grade brass or stainless steel, providing you with a long lasting burner. Limited lifetime warranty.

Stainless Steel Bullet Burners - Add -SS at the end of the part number when ordering.

Example: 8" SS Bullet Burner = OPT-B8B-SS



BULLET BURNER

	8" Burner	12" Burner	18" Burner	24" Burner	30" Burner	36" Burner	48" Burner
Part #	OPT-B8B	OPT-B12B	OPT-B18B	OPT-B24B	OPT-B30B	OPT-B36B	OPT-B48B
Diameter	8"	12"	18"	24"	30"	36"	48"
Weight	2 lbs.	3 lbs.	4 lbs.	6 lbs.	7 lbs.	9 lbs.	18 lbs.
Hub	½"	½"	½"	½"	¾"	¾"	¾"
BTU	65,000	100,000	150,000	200,000	250,000	300,000	380,000



LINEAR BULLET BURNER

	18" Burner	24" Burner	30" Burner	36" Burner	48" Burner	60" Burner	72" Burner	84" Burner	96" Burner
Part #	OPT-B18BT	OPT-B24BT	OPT-B30BT	OPT-B36BT	OPT-B48BT	OPT-B60BT	OPT-B72BT	OPT-B84BT	OPT-B96BT
Length	18"	24"	30"	36"	48"	60"	72"	84"	96"
Weight	1.5 lbs.	2 lbs.	2.5 lbs.	3 lbs.	3.5 lbs.	4 lbs.	5 lbs.	7 lbs.	9.5 lbs.
Hub	½"	½"	½"	½"	½"	½"	½"	¾"	¾"
BTU	65,000	65,000	75,000	90,000	120,000	150,000	180,000	210,000	240,000



'H' BULLET BURNER

	18" Burner	24" Burner	30" Burner	36" Burner	48" Burner	60" Burner	72" Burner
Part #	OPT-B18BH	OPT-B24BH	OPT-B30BH	OPT-B36BH	OPT-B48BH	OPT-B60BH	OPT-B72BH
Size	18" x 6"	24" x 6"	30" x 6"	36" x 6"	48" x 6"	60" x 6"	72" x 6"
Weight	2 lbs.	2.5 lbs.	3 lbs.	4 lbs.	6 lbs.	8.5 lbs.	11 lbs.
Hub	½"	½"	½"	½"	½"	¾"	¾"
BTU	85,000	120,000	150,000	180,000	210,000	255,000	285,000



Natural Gas Kit
OPT-NGKNG - up to 290K BTU
OPT-NGKNGHC - over 290K BTU
SOLD SEPARATELY



Liquid Propane Kit
OPT-LPKLP - up to 290K BTU
OPT-LPKLPHC - Over 290K BTU
SOLD SEPARATELY

ELECTRONIC IGNITION KITS, GAS KITS, AND OTHER ACCESSORIES FOUND ON PAGES 34-39

FLAT PANS & BULLET BURNERS - BRASS OR STAINLESS STEEL

The Patented Bullet Burner's eliminate the need for an additional LP air mixer. Suitable for either natural gas or liquid propane applications. Manufactured with high grade brass or stainless steel, providing you with a long lasting burner. Limited lifetime warranty. Made in the U.S.A.

Stainless Steel Bullet Burners - Add -SS at the end of the part number when ordering.

Example: 8" SS Bullet Burner = OPT-B8B-SS



ALUMINUM FLAT PAN & ROUND BULLET BURNER



	18" Pan Kit - A	18" Pan Kit - B	24" Pan Kit	30" Pan Kit	36" Pan Kit	48" Pan Kit	60" Pan Kit
Match Lit	OPT-BFP8R	OPT-BFP12R	OPT-BFP18R	OPT-BFP24R	OPT-BFP30R	OPT-BFP36R	OPT-BFP48R
12V - CSA Certified	OPT-BFP8RE12	OPT-BFP12RE12	OPT-BFP18RE12	OPT-BFP24RE12	OPT-BFP30RE12	OPT-BFP36RE12	OPT-BFP48RE12
Pan Diameter	18"	18"	24"	30"	36"	48"	60"
Burner	8"	12"	18"	24"	30"	36"	48"
Weight	5 lbs.	7 lbs.	9 lbs.	16 lbs.	19 lbs.	29 lbs.	38 lbs.
Hub	½"	½"	½"	½"	¾"	¾"	¾"
BTU	65,000	100,000	150,000	200,000	250,000	300,000	380,000
Cert. BTU	65K	65K	65K	n/a	n/a	n/a	n/a



ALUMINUM FLAT PAN & LINEAR BULLET BURNER



	30"x8" Pan Kit	42"x8" Pan Kit	60"x8" Pan Kit	72"x8" Pan Kit	84"x8" Pan Kit	96"x8" Pan Kit
Match Lit	OPT-BFP24RT	OPT-BFP36RT	OPT-BFP48RT	OPT-BFP60RT	OPT-BFP72RT	OPT-BFP84RT
12V - CSA Certified	OPT-BFP24RTE12	OPT-BFP36RTE12	OPT-BFP48RTE12	OPT-BFP60RTE12	OPT-BFP72RTE12	OPT-BFP84RTE12
Pan Dimensions	30" x 8"	42" x 8"	60" x 8"	72" x 8"	84" x 8"	96" x 8"
Burner	24"	36"	48"	60"	72"	84"
Weight	8 lbs.	11 lbs.	12.5 lbs.	17 lbs.	24 lbs.	35 lbs.
Hub	½"	½"	½"	½"	½"	¾"
BTU	65,000	90,000	120,000	150,000	180,000	210,000
Cert. BTU	65,000	65,000	65,000	n/a	n/a	n/a



Remote Control Option
OPT-400-XREMOTE
SOLD SEPARATELY



Natural Gas Kit
OPT-NGKNG - up to 290K BTU
OPT-NGKNGHC - over 290K BTU
SOLD SEPARATELY



Liquid Propane Kit
OPT-LPKLP - up to 290K BTU
OPT-LPKLPHC - Over 290K BTU
SOLD SEPARATELY

ELECTRONIC IGNITION KITS, GAS KITS, AND OTHER ACCESSORIES FOUND ON PAGES 34-39

FLAT PANS & BULLET BURNERS - BRASS OR STAINLESS STEEL

The Patented Bullet Burner's eliminate the need for an additional LP air mixer. Suitable for either natural gas or liquid propane applications. Manufactured with high grade brass or stainless steel, providing you with a long lasting burner. Limited lifetime warranty. **Made in the U.S.A.**

Stainless Steel Bullet Burners - Add -SS at the end of the part number when ordering.

Example: 8" SS Bullet Burner = OPT-B8B-SS



SQUARE FLAT PAN & BULLET BURNER



	18" Pan Kit - A	18" Pan Kit - B	24" Pan Kit	30" Pan Kit	36" Pan Kit	48" Pan Kit	60" Pan Kit
Match Lit	OPT-BFP8S	OPT-BFP12S	OPT-BFP18S	OPT-BFP24S	OPT-BFP30S	OPT-BFP36S	OPT-BFP48S
12V - CSA Certified	OPT-BFP8SE12	OPT-BFP12SE12	OPT-BFP18SE12	OPT-BFP24SE12	OPT-BFP30SE12	OPT-BFP36SE12	OPT-BFP48SE12
Pan Dimensions	18" x 18"	18" x 18"	24" x 24"	30" x 30"	36" x 36"	48" x 48"	60" x 60"
Burner	8"	12"	18"	24"	30"	36"	48"
Weight	5 lbs.	7 lbs.	9 lbs.	16 lbs.	19 lbs.	29 lbs.	38 lbs.
Hub	½"	½"	½"	½"	¾"	¾"	¾"
BTU	65,000	100,000	150,000	200,000	250,000	300,000	380,000
Cert. BTU	65,000	65,000	65,000	n/a	n/a	n/a	n/a



ALUMINUM FLAT PAN & 'H' BULLET BURNER



	24"x12" Pan Kit	36"x12" Pan Kit	48"x12" Pan Kit	60"x12" Pan Kit	72"x12" Pan Kit	84"x12" Pan Kit
Match Lit	OPT-BFP1224R	OPT-BFP1236R	OPT-BFP1248R	OPT-BFP1260R	OPT-BFP1272R	OPT-BFP1284R
12V - CSA Certified	OPT-BFP1224RE12	OPT-BFP1236RE12	OPT-BFP1248RE12	OPT-BFP1260RE12	OPT-BFP1272RE12	OPT-BFP1284RE12
Pan Dimensions	24" x 12"	36" x 12"	48" x 12"	60" x 12"	72" x 12"	84" x 12"
Burner	18" x 6"	30" x 6"	36" x 6"	48" x 6"	60" x 6"	72" x 6"
Weight	8 lbs.	11 lbs.	12.5 lbs.	17 lbs.	24 lbs.	35 lbs.
Hub	½"	½"	½"	½"	½"	½"
BTU	90,000	120,000	180,000	210,000	255,000	285,000
Cert. BTU	65,000	65,000	n/a	n/a	n/a	n/a



Remote Control Option
OPT-400-XREMOTE
SOLD SEPARATELY



Natural Gas Kit
OPT-NGKNG - up to 290K BTU
OPT-NGKNGHC - over 290K BTU
SOLD SEPARATELY



Liquid Propane Kit
OPT-LPKLP - up to 290K BTU
OPT-LPKLPHC - Over 290K BTU
SOLD SEPARATELY

ELECTRONIC IGNITION KITS, GAS KITS, AND OTHER ACCESSORIES FOUND ON PAGES 34-39

DROP IN PANS & BULLET BURNERS

The Patented Bullet Burner's eliminate the need for an additional LP air mixer. Suitable for either natural gas or liquid propane applications. Manufactured with high grade brass or stainless steel, providing you with a long lasting burner. Limited lifetime warranty. **Made in the U.S.A.**

Stainless Steel Bullet Burners - Add -SS at the end of the part number when ordering.

Example: 8" SS Bullet Burner = OPT-B8B-SS



ROUND DROP IN PAN & BULLET BURNER



	13" Pan Kit	19" Pan Kit	25" Pan Kit	31" Pan Kit	37" Pan Kit	43" Pan Kit
Match Lit	OPT-BP13RD	OPT-BP19RD	OPT-BP25RD	OPT-BP31RD	OPT-BP37RD	OPT-BP43RD
12V - CSA Certified	OPT-BP13RDE12	OPT-BP19RDE12	OPT-BP25RDE12	OPT-BP31RDE12	OPT-BP37RDE12	OPT-BP43RDE12
Pan Inner Diameter	13"	19"	25"	31"	37"	43"
Pan Lip	1"	1"	1"	1"	1"	1"
Pan Depth	2"	2"	2"	2"	2"	2"
Burner	8"	12"	18"	24"	30"	36"
Weight	6.5 lbs.	7.5 lbs.	11 lbs.	19 lbs.	25 lbs.	29 lbs.
Hub	½"	½"	½"	½"	¾"	¾"
BTU	65,000	100,000	150,000	200,000	250,000	300,000
Cert. BTU	65,000	65,000	65,000	n/a	n/a	n/a



RECTANGULAR DROP IN PAN & LINEAR BULLET BURNER



	24"x8" Pan Kit	36"x8" Pan Kit	48"x8" Pan Kit	60"x8" Pan Kit	72"x8" Pan Kit	84"x8" Pan Kit
Match Lit	OPT-BP824RD	OPT-BP836RD	OPT-BP848RD	OPT-BP860RD	OPT-BP872RD	OPT-BP884RD
12V - CSA Certified	OPT-BP824RDE12	OPT-BP836RDE12	OPT-BP848RDE12	OPT-BP860RDE12	OPT-BP872RDE12	OPT-BP884RDE12
Pan Dimensions	24" x 8"	36" x 8"	48" x 8"	60" x 8"	72" x 8"	84" x 8"
Burner	18"	24"	36"	48"	60"	72"
Weight	8 lbs.	11 lbs.	12.5 lbs.	17 lbs.	24 lbs.	35 lbs.
Hub	½"	½"	½"	½"	¾"	¾"
BTU	65,000	65,000	90,000	120,000	150,000	0,000
Cert. BTU	65,000	65,000	65,000	n/a	n/a	n/a



Remote Control Option
OPT-400-XREMOTE
SOLD SEPARATELY



Natural Gas Kit
OPT-NGKNG - up to 290K BTU
OPT-NGKNGHC - over 290K BTU
SOLD SEPARATELY



Liquid Propane Kit
OPT-LPKLP - up to 290K BTU
OPT-LPKLPHC - Over 290K BTU
SOLD SEPARATELY

ELECTRONIC IGNITION KITS, GAS KITS, AND OTHER ACCESSORIES FOUND ON PAGES 34-39

DROP IN PANS & BULLET BURNERS

The Patented Bullet Burner's eliminate the need for an additional LP air mixer. Suitable for either natural gas or liquid propane applications. Manufactured with high grade brass or stainless steel, providing you with a long lasting burner. Limited lifetime warranty. **Made in the U.S.A.**

Stainless Steel Bullet Burners - Add -SS at the end of the part number when ordering.

Example: 8" SS Bullet Burner = OPT-B8B-SS



SQUARE DROP IN PAN & BULLET BURNER



	12" Drop In Pan Kit	18" Drop In Pan Kit	24" Drop In Pan Kit	30" Drop In Pan Kit	36" Drop In Pan Kit	48" Drop In Pan Kit
Match Lit	OPT-BP12SD	OPT-BP18SD	OPT-BP24SD	OPT-BP30SD	OPT-BP36SD	OPT-BP48SD
12V - CSA Certified	OPT-BP12SDE12	OPT-BP18SDE12	OPT-BP24SDE12	OPT-BP30SDE12	OPT-BP36SDE12	OPT-BP48SDE12
Pan Inner Dimensions	12" x 12"	18" x 18"	24" x 24"	30" x 30"	36" x 36"	48" x 48"
Pan Lip	1"	1"	1"	1"	1"	1"
Pan Depth	2"	2"	2"	2"	2"	2"
Burner	8"	12"	18"	24"	30"	36"
Weight	7 lbs.	8.5 lbs.	12 lbs.	21 lbs.	27 lbs.	32 lbs.
Hub	½"	½"	½"	½"	¾"	¾"
BTU	65,000	100,000	150,000	200,000	250,000	300,000
Cert. BTU	65,000	65,000	65,000	n/a	n/a	n/a



RECTANGULAR DROP IN PAN & 'H' BULLET BURNER



	24"x12" Pan Kit	36"x12" Pan Kit	48"x12" Pan Kit	60"x12" Pan Kit	72"x12" Pan Kit	84"x12" Pan Kit
Match Lit	OPT-BP1224RD	OPT-BP1236RD	OPT-BP1248RD	OPT-BP1260RD	OPT-BP1272RD	OPT-BP1284RD
12V - CSA Certified	OPT-BP1224RDE12	OPT-BP1236RDE12	OPT-BP1248RDE12	OPT-BP1260RDE12	OPT-BP1272RDE12	OPT-BP1284RDE12
Pan Inner Dimensions	24" x 12"	36" x 12"	48" x 12"	60" x 12"	72" x 12"	84" x 12"
Burner	18" x 6"	24" x 6"	36" x 6"	48" x 6"	60" x 6"	72" x 6"
Weight	8 lbs.	11 lbs.	12.5 lbs.	17 lbs.	24 lbs.	35 lbs.
Hub	½"	½"	½"	½"	¾"	½"
BTU	90,000	120,000	180,000	210,000	255,000	285,000
Cert. BTU	65,000	65,000	n/a	n/a	n/a	n/a



Remote Control Option
OPT-400-XREMOTE
SOLD SEPARATELY



Natural Gas Kit
OPT-NGKNG - up to 290K BTU
OPT-NGKNGHC - over 290K BTU
SOLD SEPARATELY



Liquid Propane Kit
OPT-LPKLP - up to 290K BTU
OPT-LPKLPHC - Over 290K BTU
SOLD SEPARATELY

ELECTRONIC IGNITION KITS, GAS KITS, AND OTHER ACCESSORIES FOUND ON PAGES 34-39



BRASS BULLET BURNERS



Flat Flame Technology
More Flame, Less Gas!

Life Time Warranty on ALL Burners
(Brass & Stainless Steel)

STAINLESS STEEL PANS & BURNER KITS

LIFETIME WARRANTY ON ALL STAINLESS STEEL BURNERS

LIQUID PROPANE applications require a Brass Air Mixer Orifice. This orifice integrates air into the propane for a cleaner burning flame. This prevents soot from being created and staining the unit and other surroundings.

NATURAL GAS applications come with a brass orifice mounted directly underneath the burner.

- » Holes drilled on the side of the burner, not the top, to reduce water from entering.
- » Holes Individually drilled, not punched, providing better flame performance.
- » 1/8" Holes for optimal gas output
- » Slight taper to reduce the risk of water run off entering the gas line
- » 304 stainless steel is the standard for all of The Outdoor Plus' burners.
- » .065 Burner wall thickness prevents burners from warping from the heat and adds longevity
- » Each burner is fabricated by hand with attention to detail to provide you with a high quality product you can rely on.

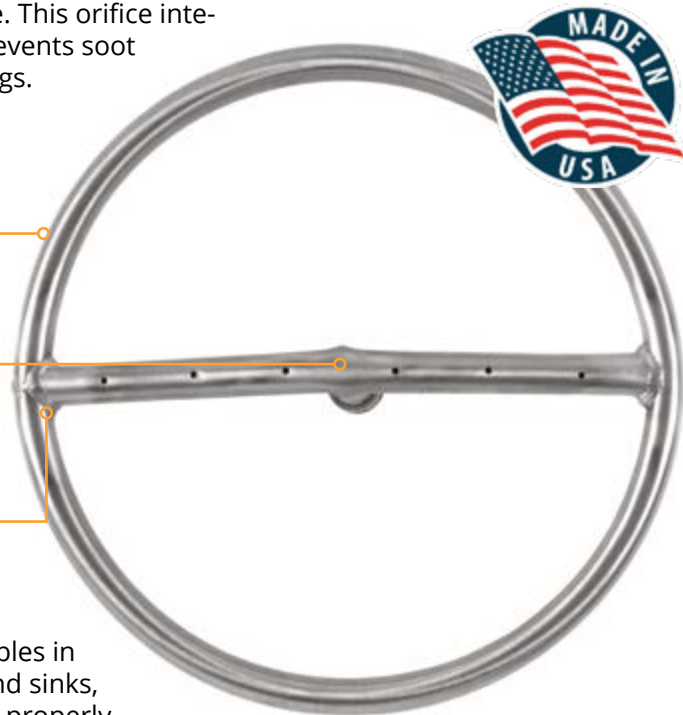

PROPANE & GLASS ADVISORY

It is not recommended to use any sort of fire glass or glass pebbles in Liquid Propane applications. Propane is 1.5x heavier than air and sinks, decorative glass is dense and may not allow the the propane to properly rise. Propane may collect and pool under the surface of the glass or inside the enclosure creating a potentially dangerous situation.

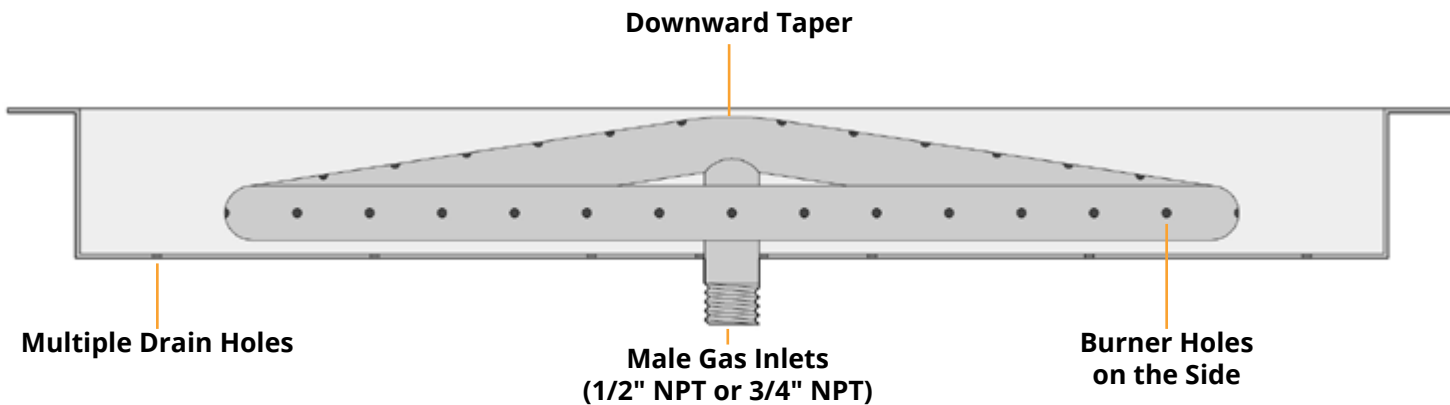

GAS CONVERSION KIT AVAILABLE

Our burners are made to be used with either Liquid Propane or Natural Gas, just make sure you have the correct orifice and gas lines on there if you ever decide to convert your unit's gas type.



LP ORIFICE



NG ORIFICE

FLAT PAN & BURNER

Constructed from 304 Stainless Steel. Multiple weep holes for proper water runoff. Raised gas inlet to prevent water from entering the gas line. LP or NG compatible. **Custom Sizes Available**

LIFETIME WARRANTY ON ALL STAINLESS STEEL BURNERS



ROUND STAINLESS STEEL PAN & ROUND BURNER



	12" Pan Kit	18" Pan Kit	24" Pan Kit	30" Pan Kit	36" Pan Kit	42" Pan Kit	48" Pan Kit
Match Lit	OPT-110012BP	OPT-110018BP	OPT-110024BP	OPT-110030BP	OPT-110036BP	OPT-110042BP	OPT-110048BP
12V - CSA Certified	OPT-110012BPE12	OPT-110018BPE12	OPT-110024BPE12	OPT-110030BPE12	OPT-110036BPE12	OPT-110042BPE12	OPT-110048BPE12
Pan Diameter	12"	18"	24"	30"	36"	42"	48"
Burner	6" Single	12" Single	18" Double	24" Double	30" Triple	36" Triple	48" Triple
Height	1 3/4"	1 3/4"	1 3/4"	1 3/4"	1 3/4"	1 3/4"	1 3/4"
Hub	1/2"	1/2"	1/2"	1/2"	3/4"	3/4"	3/4"
BTU	65,000	90,000	160,000	190,000	310,000	375,000	375,000
Cert. BTU	65,000	65,000	65,000	n/a	n/a	n/a	n/a



ROUND STAINLESS STEEL PAN & LOTUS BURNER



	24" Pan Kit	30" Pan Kit	36" Pan Kit	42" Pan Kit	48" Pan Kit
Match Lit	OPT-FRLB24	OPT-FRLB30	OPT-FRLB36	OPT-FRLB42	OPT-FRLB48
12V - CSA Certified	OPT-FRLB24E12	OPT-FRLB30E12	OPT-FRLB36E12	OPT-FRLB42E12	OPT-FRLB48E12
Pan Diameter	24"	30"	36"	42"	48"
Burner	18"	24"	30"	36"	36"
Height	1 3/4"	1 3/4"	1 3/4"	1 3/4"	1 3/4"
Hub	1/2"	1/2"	3/4"	3/4"	3/4"
BTU	120,000	190,000	260,000	340,000	340,000
Cert. BTU	65,000	n/a	n/a	n/a	n/a



ROUND STAINLESS STEEL PAN & TRIPLE 'S' BURNER



	24" Pan Kit	30" Pan Kit	36" Pan Kit	42" Pan Kit	48" Pan Kit
Match Lit	OPT-F3524	OPT-F3530	OPT-F3536	OPT-F3542	OPT-F3548
12V - CSA Certified	OPT-F3524E12	OPT-F3530E12	OPT-F3536E12	OPT-F3542E12	OPT-F3548E12
Pan Diameter	24"	30"	36"	42"	48"
Burner	18"	24"	30"	30"	36"
Height	1 3/4"	1 3/4"	1 3/4"	1 3/4"	1 3/4"
Hub	1/2"	1/2"	3/4"	3/4"	3/4"
BTU	110,000	150,000	190,000	190,000	240,000
Cert. BTU	65,000	n/a	n/a	n/a	n/a

FLAT PAN & BURNER

Constructed from 304 Stainless Steel. Multiple weep holes for proper water runoff. Raised gas inlet to prevent water from entering the gas line. LP or NG compatible. **Custom Sizes Available**

LIFETIME WARRANTY ON ALL STAINLESS STEEL BURNERS



SQUARE STAINLESS STEEL PAN & SQUARE BURNER



	16.5" Pan Kit	18" Pan Kit	24" Pan Kit	30" Pan Kit	36" Pan Kit	48" Pan Kit
Match Lit	OPT-999BP16	OPT-999BP18	OPT-999BP24	OPT-999BP30	OPT-999BP36	OPT-999BP48
12V - CSA Certified	OPT-999BP16E12	OPT-999BP18E12	OPT-999BP24E12	OPT-999BP30E12	OPT-999BP36E12	OPT-999BP48E12
Pan Dimensions	16.5" x 16.5"	18" x 18"	24" x 24"	30" x 30"	36" x 36"	48" x 48"
Burner	12" Single	12" Single	18" Double	24" Double	30" Triple	36" Triple
Height	1 3/4"	1 3/4"	1 3/4"	1 3/4"	1 3/4"	1 3/4"
Hub	1/2"	1/2"	1/2"	1/2"	3/4"	3/4"
BTU	65,000	90,000	160,000	190,000	310,000	375,000
Cert. BTU	65,000	65,000	65,000	n/a	n/a	n/a



SQUARE STAINLESS STEEL PAN & LOTUS BURNER



	16.5" Pan Kit	18" Pan Kit	24" Pan Kit	30" Pan Kit	36" Pan Kit	48" Pan Kit
Match Lit	OPT-FSLB16	OPT-FSLB18	OPT-FSLB24	OPT-FSLB30	OPT-FSLB36	OPT-FSLB48
12V - CSA Certified	OPT-FSLB16E12	OPT-FSLB18E12	OPT-FSLB24E12	OPT-FSLB30E12	OPT-FSLB36E12	OPT-FSLB48E12
Pan Dimensions	16.5" x 16.5"	18" x 18"	24" x 24"	30" x 30"	36" x 36"	48" x 48"
Burner	12"	12"	18"	24"	30"	36"
Height	1 3/4"	1 3/4"	1 3/4"	1 3/4"	1 3/4"	1 3/4"
Hub	1/2"	1/2"	1/2"	1/2"	3/4"	3/4"
BTU	90,000	90,000	110,000	150,000	190,000	240,000
Cert. BTU	65,000	65,000	65,000	n/a	n/a	n/a



SQUARE STAINLESS STEEL PAN & TRIPLE 'S' BURNER



	16.5" Pan Kit	18" Pan Kit	24" Pan Kit	30" Pan Kit	36" Pan Kit	48" Pan Kit
Match Lit	OPT-FS3516	OPT-FS3518	OPT-FS3524	OPT-FS3530	OPT-FS3536	OPT-FS3548
12V - CSA Certified	OPT-FS3516E12	OPT-FS3518E12	OPT-FS3524E12	OPT-FS3530E12	OPT-FS3536E12	OPT-FS3548E12
Pan Dimensions	16.5" x 16.5"	18" x 18"	24" x 24"	30" x 30"	36" x 36"	48" x 48"
Burner	12"	12"	18"	24"	30"	36"
Height	1 3/4"	1 3/4"	1 3/4"	1 3/4"	1 3/4"	1 3/4"
Hub	1/2"	1/2"	1/2"	1/2"	3/4"	3/4"
BTU	90,000	90,000	115,000	175,000	220,000	265,000
Cert. BTU	65,000	65,000	65,000	n/a	n/a	n/a

FLAT PAN & BURNER

Constructed from 304 Stainless Steel. Multiple weep holes for proper water runoff. Raised gas inlet to prevent water from entering the gas line. LP or NG compatible. **Custom Sizes Available**

LIFETIME WARRANTY ON ALL STAINLESS STEEL BURNERS



STAINLESS STEEL PAN & LINEAR BURNER



	24" x 6" Pan Kit	30" x 6" Pan Kit	36" x 6" Pan Kit	42" x 6" Pan Kit	48" x 6" Pan Kit
Match Lit	OPT-REFS624	OPT-REFS630	OPT-REFS636	OPT-REFS642	OPT-REFS648
12V - CSA Certified	OPT-REFS624E12	OPT-REFS630E12	OPT-REFS636E12	OPT-REFS642E12	OPT-REFS648E12
Pan Dimensions	24" x 6"	30" x 6"	36" x 6"	42" x 6"	48" x 6"
Burner	18"	24"	30"	36"	42"
Height	1 3/4"	1 3/4"	1 3/4"	1 3/4"	1 3/4"
Hub	1/2"	1/2"	1/2"	1/2"	1/2"
BTU	25,000	40,000	50,000	60,000	75,000
Cert. BTU	25,000	40,000	50,000	60,000	75,000

	24" x 8" Pan Kit	30" x 8" Pan Kit	36" x 8" Pan Kit	42" x 8" Pan Kit	48" x 8" Pan Kit
Match Lit	OPT-REFS824	OPT-REFS830	OPT-REFS836	OPT-REFS842	OPT-REFS848
12V - CSA Certified	OPT-REFS824E12	OPT-REFS830E12	OPT-REFS836E12	OPT-REFS842E12	OPT-REFS848E12
Pan Dimensions	24" x 8"	30" x 8"	36" x 8"	42" x 8"	48" x 8"
Burner	18"	24"	30"	36"	42"
Height	1 3/4"	1 3/4"	1 3/4"	1 3/4"	1 3/4"
Hub	1/2"	1/2"	1/2"	1/2"	1/2"
BTU	25,000	40,000	50,000	60,000	75,000
Cert. BTU	25,000	40,000	50,000	60,000	65,000

Z-MOUNTING BRACKETS

Z-Brackets are designed to ease & speed up installation of flat pan kits. Flexible to suit both rectangular and round fire pits. Stainless Steel, not galvanized, for added longevity.



OPT-ZBRKT
Width: 24"
Height: 2"
Includes: Flexible Bracket - Set of 4

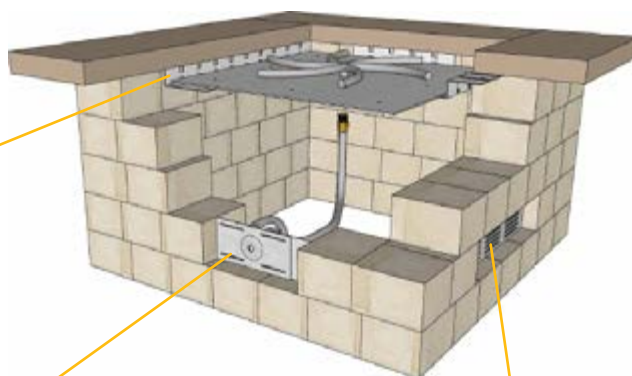

ADJUSTABLE PAVER BRACKETS



OPT-PB256
Height: 3.875"
Width: min - 8" ; max - 14"
Includes: Adjustable Bracket, Key Valve, turn key

FIRE PIT VENT



OPT-VENT164
16" x 4" Stainless Steel Vent Cover



Remote Control Option
OPT-400-XREMOTE
SOLD SEPARATELY



Natural Gas Kit
OPT-NGKNG- up to 290K BTU
OPT-NGKNGHC - over 290K BTU
SOLD SEPARATELY



Liquid Propane Kit
OPT-LPKLP - up to 290K BTU
OPT-LPKLPHC - Over 290K BTU
SOLD SEPARATELY

ELECTRONIC IGNITION KITS, GAS KITS, AND OTHER ACCESSORIES FOUND ON PAGES 34-39

FLAT PAN & BURNER

Constructed from 304 Stainless Steel. Multiple weep holes for proper water runoff. Raised gas inlet to prevent water from entering the gas line. LP or NG compatible. **Custom Sizes Available**

LIFETIME WARRANTY ON ALL STAINLESS STEEL BURNERS



STAINLESS STEEL PAN & 'H' BURNER



	24" x 12" Pan Kit	30" x 12" Pan Kit	36" x 12" Pan Kit	42" x 12" Pan Kit	48" x 12" Pan Kit
Match Lit	OPT-REFD1224	OPT-REFD1230	OPT-REFD1236	OPT-REFD1242	OPT-REFD1248
12V - CSA Certified	OPT-REFD1224E12	OPT-REFD1230E12	OPT-REFD1236E12	OPT-REFD1242E12	OPT-REFD1248E12
Pan Dimensions	24" x 12"	30" x 12"	36" x 12"	42" x 12"	48" x 12"
Burner	18" x 6"	24" x 6"	30" x 6"	36" x 6"	42" x 6"
Height	1 3/4"	1 3/4"	1 3/4"	1 3/4"	1 3/4"
Hub	1/2"	1/2"	1/2"	1/2"	1/2"
BTU	60,000	80,000	100,000	120,000	150,000
Cert. BTU	65,000	65,000	65,000	65,000	n/a

	24" x 18" Pan Kit	30" x 18" Pan Kit	36" x 18" Pan Kit	42" x 18" Pan Kit	48" x 18" Pan Kit
Match Lit	OPT-REFD1824	OPT-REFD1830	OPT-REFD1836	OPT-REFD1842	OPT-REFD1848
12V - CSA Certified	OPT-REFD1824E12	OPT-REFD1830E12	OPT-REFD1836E12	OPT-REFD1842E12	OPT-REFD1848E12
Pan Dimensions	24" x 18"	30" x 18"	36" x 18"	42" x 18"	48" x 18"
Burner	18" x 12"	24" x 12"	30" x 12"	36" x 12"	42" x 12"
Height	1 3/4"	1 3/4"	1 3/4"	1 3/4"	1 3/4"
Hub	1/2"	1/2"	1/2"	1/2"	1/2"
BTU	70,000	90,000	110,000	130,000	160,000
Cert. BTU	65,000	65,000	65,000	n/a	n/a



STAINLESS STEEL PAN & RECTANGULAR BURNER



	24" x 12" Pan Kit	30" x 12" Pan Kit	36" x 12" Pan Kit	42" x 12" Pan Kit	48" x 12" Pan Kit
Match Lit	OPT-RFRD1224	OPT-RFRD1230	OPT-RFRD1236	OPT-RFRD1242	OPT-RFRD1248
12V - CSA Certified	OPT-RFRD1224E12	OPT-RFRD1230E12	OPT-RFRD1236E12	OPT-RFRD1242E12	OPT-RFRD1248E12
Pan Dimensions	24" x 12"	30" x 12"	36" x 12"	42" x 12"	48" x 12"
Burner	18" x 6"	24" x 6"	30" x 6"	36" x 6"	42" x 6"
Height	1 3/4"	1 3/4"	1 3/4"	1 3/4"	1 3/4"
Hub	1/2"	1/2"	1/2"	1/2"	1/2"
BTU	80,000	90,000	110,000	130,000	170,000
Cert. BTU	65,000	65,000	65,000	65,000	n/a

	24" x 18" Pan Kit	30" x 18" Pan Kit	36" x 18" Pan Kit	42" x 18" Pan Kit	48" x 18" Pan Kit
Match Lit	OPT-RFRD1824	OPT-RFRD1830	OPT-RFRD1836	OPT-RFRD1842	OPT-RFRD1848
12V - CSA Certified	OPT-RFRD1824E12	OPT-RFRD1830E12	OPT-RFRD1836E12	OPT-RFRD1842E12	OPT-RFRD1848E12
Pan Dimensions	24" x 18"	30" x 18"	36" x 18"	42" x 18"	48" x 18"
Burner	18" x 12" - Double	24" x 12" - Double	30" x 12" - Double	36" x 12" - Double	42" x 12" - Double
Height	1 3/4"	1 3/4"	1 3/4"	1 3/4"	1 3/4"
Hub	1/2"	1/2"	1/2"	1/2"	1/2"
BTU	100,000	120,000	140,000	180,000	200,000
Cert. BTU	65,000	65,000	n/a	n/a	n/a

DROP IN PAN & BURNER

Constructed from 304 Stainless Steel. Standard 1" seamless lip. Depth of 2". Multiple weep holes for proper water runoff. Raised gas inlet to prevent water from entering the gas line. LP or NG compatible. **Custom Sizes Available**

LIFETIME WARRANTY ON ALL STAINLESS STEEL BURNERS



ROUND DROP IN STAINLESS STEEL PAN & ROUND BURNER RING



	13" Drop In Kit	19" Drop In Kit	25" Drop In Kit	31" Drop In Kit	37" Drop In Kit	43" Drop In Kit
Match Lit	OPT-PBR13	OPT-PBR19	OPT-PBR25	OPT-PBR31	OPT-PBR37	OPT-PBR43
12V - CSA Certified	OPT-PBR13E12	OPT-PBR19E12	OPT-PBR25E12	OPT-PBR31E12	OPT-PBR37E12	OPT-PBR43E12
Pan Inside Diam.	13"	19"	25"	31"	37"	43"
Pan Depth	2"	2"	2"	2"	2"	2"
Burner	6" Single	12" Single	18" Double	24" Double	30" Triple	36" Triple
Hub	½"	½"	½"	½"	¾"	¾"
BTU	65,000	90,000	160,000	190,000	310,000	375,000
Cert. BTU	65,000	65,000	65,000	n/a	n/a	n/a



ROUND DROP IN STAINLESS STEEL PAN & LOTUS FLOWER BURNER



	19" Drop In Kit	25" Drop In Kit	31" Drop In Kit	37" Drop In Kit	43" Drop In Kit
Match Lit	OPT-PBRLF19	OPT-PBRLF25	OPT-PBRLF31	OPT-PBRLF37	OPT-PBRLF43
12V - CSA Certified	OPT-PBRLF19E12	OPT-PBRLF25E12	OPT-PBRLF31E12	OPT-PBRLF37	OPT-PBRLF43E12
Pan Inside Diam.	19"	25"	31"	37"	43"
Pan Depth	2"	2"	2"	2"	2"
Burner	12"	18"	24"	30"	36"
Hub	½"	½"	½"	¾"	¾"
BTU	90,000	115,000	175,000	220,000	265,000
Cert. BTU	65,000	65,000	n/a	n/a	n/a



ROUND DROP IN STAINLESS STEEL PAN & TRIPLE 'S' BURNER



	19" Drop In Kit	25" Drop In Kit	31" Drop In Kit	37" Drop In Kit	43" Drop In Kit
Match Lit	OPT-PBR3519	OPT-PBR3525	OPT-PBR3531	OPT-PBR3537	OPT-PBR3543
12V - CSA Certified	OPT-PBR3519E12	OPT-PBR3525E12	OPT-PBR3531E12	OPT-PBR3537	OPT-PBR3543E12
Pan Inside Diam.	19"	25"	31"	37"	43"
Pan Depth	2"	2"	2"	2"	2"
Burner	12"	18"	24"	30"	36"
Hub	½"	½"	½"	¾"	¾"
BTU	90,000	115,000	175,000	220,000	265,000
Cert. BTU	65,000	65,000	n/a	n/a	n/a



Remote Control Option
OPT-400-XREMOTE
SOLD SEPARATELY



Natural Gas Kit
OPT-NGKNG - up to 290K BTU
OPT-NGKNGHC - over 290K BTU
SOLD SEPARATELY



Liquid Propane Kit
OPT-LPKLP - up to 290K BTU
OPT-LPKLPHC - Over 290K BTU
SOLD SEPARATELY

ELECTRONIC IGNITION KITS, GAS KITS, AND OTHER ACCESSORIES FOUND ON PAGES 34-39

DROP IN PAN & BURNER

Constructed from 304 Stainless Steel. Standard 1" seamless lip. Depth of 2". Multiple weep holes for proper water runoff. Raised gas inlet to prevent water from entering the gas line. LP or NG compatible. **Custom Sizes Available**

LIFETIME WARRANTY ON ALL STAINLESS STEEL BURNERS



SQUARE DROP IN STAINLESS STEEL PAN & SQUARE BURNER RING



	16.5" Drop In Kit	18" Drop In Kit	24" Drop In Kit	30" Drop In Kit	36" Drop In Kit	48" Drop In Kit
Match Lit	OPT-PBS16	OPT-PBS18	OPT-PBS24	OPT-PBS30	OPT-PBS36	OPT-PBS48
12V - CSA Certified	OPT-PBS16E12	OPT-PBS18E12	OPT-PBS24E12	OPT-PBS30E12	OPT-PBS36E12	OPT-PBS48E12
Pan Inside Dims.	16.5" x 16.5"	18" x 18"	24" x 24"	30" x 30"	36" x 36"	48" x 48"
Pan Depth	2"	2"	2"	2"	2"	2"
Burner	12" Single	12" Single	18" Double	24" Double	30" Triple	36" Triple
Hub	½"	½"	½"	½"	¾"	¾"
BTU	90,000	90,000	160,000	190,000	310,000	375,000
Cert. BTU	65,000	65,000	65,000	n/a	n/a	n/a



SQUARE DROP IN STAINLESS STEEL PAN & LOTUS FLOWER BURNER



	16.5" Drop In Kit	18" Drop In Kit	24" Drop In Kit	30" Drop In Kit	36" Drop In Kit	48" Drop In Kit
Match Lit	OPT-PBSLF16	OPT-PBSLF18	OPT-PBSLF24	OPT-PBSLF30	OPT-PBSLF36	OPT-PBSLF48
12V - CSA Certified	OPT-PBSLF16E12	OPT-PBSLF18E12	OPT-PBSLF24E12	OPT-PBSLF30E12	OPT-PBSLF36E12	OPT-PBSLF48E12
Pan Inside Dims.	16.5" x 16.5"	18" x 18"	24" x 24"	30" x 30"	36" x 36"	48" x 48"
Pan Depth	2"	2"	2"	2"	2"	2"
Burner	12"	12"	18"	24"	30"	36"
Hub	½"	½"	½"	½"	¾"	¾"
BTU	90,000	100,000	160,000	190,000	260,000	350,000
Cert. BTU	65,000	65,000	65,000	n/a	n/a	n/a



SQUARE DROP IN STAINLESS STEEL PAN & TRIPLE 'S' BURNER



	16.5" Drop In Kit	18" Drop In Kit	24" Drop In Kit	30" Drop In Kit	36" Drop In Kit	48" Drop In Kit
Match Lit	OPT-PBS3S16	OPT-PBS3S18	OPT-PBS3S24	OPT-PBS3S30	OPT-PBS3S36	OPT-PBS3S48
12V - CSA Certified	OPT-PBS3S16E12	OPT-PBS3S18E12	OPT-PBS3S24E12	OPT-PBS3S30E12	OPT-PBS3S36E12	OPT-PBS3S48E12
Pan Inside Dims.	16.5" x 16.5"	18" x 18"	24" x 24"	30" x 30"	36" x 36"	48" x 48"
Pan Depth	2"	2"	2"	2"	2"	2"
Burner	12"	12"	18"	24"	30"	36"
Hub	½"	½"	½"	½"	¾"	¾"
BTU	90,000	90,000	110,000	150,000	190,000	240,000
Cert. BTU	65,000	65,000	65,000	n/a	n/a	n/a

Remote Control Option
OPT-400-XREMOTE
SOLD SEPARATELY



Natural Gas Kit
OPT-NGKNG - up to 290K BTU
OPT-NGKNGHC - over 290K BTU
SOLD SEPARATELY



Liquid Propane Kit
OPT-LPKLP - up to 290K BTU
OPT-LPKLPHC - Over 290K BTU
SOLD SEPARATELY

ELECTRONIC IGNITION KITS, GAS KITS, AND OTHER ACCESSORIES FOUND ON PAGES 34-39

DROP IN PAN & BURNER

Constructed from 304 Stainless Steel. Standard 1" seamless lip. Depth of 2". Multiple weep holes for proper water runoff. Raised gas inlet to prevent water from entering the gas line. LP or NG compatible. **Custom Sizes Available**

LIFETIME WARRANTY ON ALL STAINLESS STEEL BURNERS



RECTANGULAR DROP IN STAINLESS STEEL PAN & LINEAR BURNER



	24"x6" Rectangle	30"x6" Rectangle	36"x6" Rectangle	42"x6" Rectangle	48"x6" Rectangle
Match Lit	OPT-RT24	OPT-RT30	OPT-RT36	OPT-RT42	OPT-RT48
12V - CSA Certified	OPT-RT24E12	OPT-RT30E12	OPT-RT36E12	OPT-RT42E12	OPT-RT48E12
Pan Inside Dims.	24" x 6"	30" x 6"	36" x 6"	42" x 6"	48" x 6"
Pan Depth	2"	2"	2"	2"	2"
Burner	18" Linear	24" Linear	30" Linear	36" Linear	42" Linear
Hub	1/2"	1/2"	1/2"	1/2"	1/2"
BTU	30,000	35,000	50,000	65,000	80,000
Cert. BTU	30,000	35,000	50,000	65,000	65,000

	60"x6" Rectangle	72"x6" Rectangle	84"x6" Rectangle	96"x6" Rectangle
Match Lit	OPT-RT60	OPT-RT72	OPT-RT84	OPT-RT96
12V - CSA Certified	OPT-RT60E12	OPT-RT72E12	OPT-RT84E12	OPT-RT96E12
Pan Inside Dims.	60" x 6"	72" x 6"	84" x 6"	96" x 6"
Pan Depth	2"	2"	2"	2"
Burner	48" Linear	60" Linear	72" Linear	84" Linear
Hub	1/2"	1/2"	3/4"	3/4"
BTU	100,000	125,000	130,000	150,000
Cert. BTU	n/a	n/a	n/a	n/a



RECTANGULAR DROP IN STAINLESS STEEL PAN & 'H' BURNER



	24"x12" Rectangle	30"x12" Rectangle	36"x12" Rectangle	42"x12" Rectangle	48"x12" Rectangle	60"x12" Rectangle
Match Lit	OPT-PB1224	OPT-PB1230	OPT-PB1236	OPT-PB1242	OPT-PB1248	OPT-PB1260
12V - CSA Certified	OPT-PB1224E12	OPT-PB1230E12	OPT-PB1236E12	OPT-PB1242E12	OPT-PB1248E12	OPT-PB1260E12
Pan Inside Dims.	24" x 12"	30" x 12"	36" x 12"	42" x 12"	48" x 12"	60" x 12"
Pan Depth	2"	2"	2"	2"	2"	2"
Burner	18" x 6"	24" x 6"	30" x 6"	36" x 6"	42" x 6"	48" x 6"
Hub	1/2"	1/2"	1/2"	1/2"	1/2"	3/4"
BTU	60,000	80,000	100,000	120,000	140,000	160,000
Cert. BTU	60,000	65,000	65,000	n/a	n/a	n/a

	72"x12" Rectangle	84"x12" Rectangle	36"x14" Rectangle	42"x14" Rectangle	54"x16" Rectangle
Match Lit	OPT-PB1272	OPT-PB1284	OPT-PB1436	OPT-PB1442	OPT-PB1654
12V - CSA Certified	OPT-PB1272E12	OPT-PB1284E12	OPT-PB1436E12	OPT-PB1442E12	OPT-PB1654E12
Pan Inside Dims.	72" x 12"	84" x 12"	36" x 14"	42" x 14"	54" x 16"
Pan Depth	2"	2"	2"	2"	2"
Burner	60" x 6"	72" x 6"	30" x 6"	36" x 6"	48" x 6"
Hub	3/4"	3/4"	1/2"	1/2"	1/2"
BTU	200,000	240,000	60,000	120,000	160,000
Cert. BTU	n/a	n/a	60,000	n/a	n/a

DROP IN PAN & BURNER

Constructed from 304 Stainless Steel. Standard 1" seamless lip. Depth of 2". Multiple weep holes for proper water runoff. Raised gas inlet to prevent water from entering the gas line. LP or NG compatible. **Custom Sizes Available**

LIFETIME WARRANTY ON ALL STAINLESS STEEL BURNERS



V-TROUGH STAINLESS STEEL PAN & LINEAR BURNER

	24" Trough	30" Trough	36" Trough	48" Trough	60" Trough
Match Lit	OPT-RVT24	OPT-RVT30	OPT-RVT36	OPT-RVT48	OPT-RVT60
Pan Inside Dims.	24" x 5.5"	30" x 5.5"	36" x 5.5"	48" x 5.5"	60" x 5.5"
Pan Depth	4"	4"	4"	4"	4"
Burner	24" Linear	30" Linear	36" Linear	48" Linear	60" Linear
Hub	½"	½"	½"	½"	½"
BTU	35,000	50,000	65,000	80,000	100,000
Cert. BTU	35,000	50,000	65,000	65,000	65,000

	72" Trough	84" Trough	96" Trough
Match Lit	OPT-RVT72	OPT-RVT84	OPT-RVT96
Pan Inside Dims.	72" x 5.5"	84" x 5.5"	96" x 5.5"
Pan Depth	4"	4"	4"
Burner	72" Linear	84" Linear	96" Linear
Hub	¾"	¾"	¾"
BTU	120,000	140,000	160,000
Cert. BTU	n/a	n/a	n/a

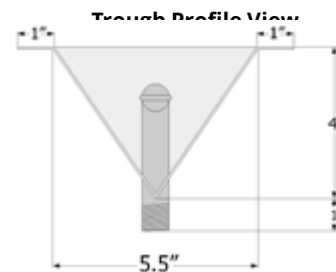

Remote Control Add-On
OPT-400-XREMOTE



Natural Gas Kit
OPT-NGKNG - up to 290K BTU
OPT-NGKNGHC - over 290K BTU
SOLD SEPARATELY



Liquid Propane Kit
OPT-LPKLP - up to 290K BTU
OPT-LPKLPHC - Over 290K BTU
SOLD SEPARATELY

ELECTRONIC IGNITION KITS, GAS KITS, AND OTHER ACCESSORIES FOUND ON PAGES 34-39



CUSTOM DROP IN PAN AND BURNER
Octagon Shaped

STAINLESS STEEL BURNERS

Our fire burners are individually crafted from 304 stainless steel. Our burner holes are individually drilled, not punched, creating a better flame. Gas inlets are slightly raised to prevent water from entering your gas line. NG or LP compatible. Made in the USA.

LIFETIME WARRANTY ON ALL STAINLESS STEEL BURNERS

ROUND SS BURNER

Male connection



Part Number	Size	HUB	BTU
OPT-158-5	5"	1/2"	40K
OPT-158	6"	1/2"	40K
OPT-158-8	8"	1/2"	65K
OPT-159	12"	1/2"	85K
OPT-160	18"	1/2"	160K
OPT-161	24"	1/2"	190K
OPT-161-30	30"	3/4"	310K
OPT-162	36"	3/4"	375K
OPT-162-48	48"	x2 - 3/4"	550K

TRIPLE "S" STAR BURNER

Male connection



Part Number	Size	HUB	BTU
OPT-3S12	12"	1/2"	90K
OPT-3S18	18"	1/2"	150K
OPT-3S24	24"	1/2"	150K
OPT-3S30	30"	3/4"	200K
OPT-3S36	36"	3/4"	290K
OPT-3S42	42"	3/4"	300K
OPT-3S48	48"	3/4"	300K

"H" BURNER

Male connection



Part Number	Size	HUB	BTU
OPT-181	6"x18"	1/2"	50K
OPT-182	6"x24"	1/2"	60K
OPT-183	6"x30"	1/2"	70K
OPT-184	6"x36"	1/2"	150K
OPT-18448	6"x48"	3/4"	200K
OPT-18466	6"x60"	3/4"	220K
OPT-18472	6"x72"	3/4"	220K
OPT-18484	6"x84"	3/4"	275K
OPT-18496	6"x96"	3/4"	300K

"T" BURNER

Male connection



Part Number	Size	HUB	BTU
OPT-16616	16"	1/2"	50K
OPT-167	24"	1/2"	50K
OPT-168	30"	1/2"	60K
OPT-169	36"	1/2"	75K
OPT-166T48	48"	1/2"	100K
OPT-166T60	60"	1/2"	125K
OPT-166T72	72"	3/4"	150K
OPT-166T84	84"	3/4"	170K
OPT-166T96	96"	3/4"	200K
OPT-166T108	108"	3/4"	220K
OPT-166T120	120"	3/4"	240K

FIREPLACE H-BURNER

Male connection



Part Number	Size	HUB	BTU
OPT-154	6"x18"	1/2"	90K
OPT-155	6"x24"	1/2"	90K
OPT-156	6"x30"	1/2"	95K
OPT-157	6"x36"	1/2"	100K
OPT-15748	12"x48"	3/4"	125K
OPT-15760	12"x60"	3/4"	140K
OPT-15772	12"x72"	3/4"	175K

FIREPLACE LOG LIGHTER BURNER

Male connection



Part Number	Size	HUB	BTU
OPT-173-12	12"	1/2"	20K
OPT-173	18"	1/2"	30K
OPT-174	24"	1/2"	40K
OPT-175	30"	1/2"	50K
OPT-17536	36"	1/2"	60K
OPT-17542	42"	1/2"	70K
OPT-17548	48"	1/2"	80K
OPT-17560	60"	3/4"	90K

STAINLESS STEEL BURNERS

Our fire burners are individually crafted from 304 stainless steel. Our burner holes are individually drilled, not punched, creating a better flame. Gas inlets are slightly raised to prevent water from entering your gas line. NG or LP compatible. Made in the USA.

LIFETIME WARRANTY ON ALL STAINLESS STEEL BURNERS

SQUARE SS BURNER



Part Number	Size	HUB	BTU
OPT-30076	6"x6"	1/2"	65K
OPT-3007	12"x12"	1/2"	90K
OPT-3008	18"x18"	1/2"	150K
OPT-3009	24"x24"	1/2"	150K
OPT-300930	30"x30"	3/4"	290K
OPT-300936	36"x36"	3/4"	300K
OPT-300942	42"x42"	3/4"	300K
OPT-300948	48"x48"	x2 - 3/4"	325K
OPT-300960	60"x60"	x2 - 3/4"	400K

TRIANGLE SS BURNER



Part Number	Size	HUB	BTU
OPT-3001	12"	1/2"	90K
OPT-3002	18"	1/2"	150K
OPT-3003	24"	1/2"	150K
OPT-300330	30"	3/4"	290K
OPT-3004	36"	3/4"	300K
OPT-300448	48"	3/4"	300K

RECTANGLE SS BURNER



Part Number	Size	HUB	BTU
OPT-3010	8"x12"	1/2"	90K
OPT-3011	8"x18"	1/2"	100K
OPT-301124	8"x24"	1/2"	100K
OPT-301130	8"x30"	1/2"	140K
OPT-301136	8"x36"	1/2"	160K
OPT-301148	8"x48"	3/4"	200K
OPT-3012	12"x24"	1/2"	100K
OPT-301230	12"x30"	1/2"	120K
OPT-301236	12"x36"	1/2"	120K
OPT-301242	12"x42"	1/2"	160K
OPT-301248	12"x48"	3/4"	175K
OPT-301260	12"x60"	3/4"	180K
OPT-301272	12"x72"	3/4"	260K

DOUBLE RECTANGLE SS BURNER



Part Number	Size	HUB	BTU
OPT-DR1224	12"x24"	1/2"	90K
OPT-DR1230	12"x30"	1/2"	100K
OPT-DR1236	12"x36"	1/2"	120K
OPT-DR1242	12"x42"	1/2"	160K
OPT-DR1248	12"x48"	3/4"	180K
OPT-DR1260	12"x60"	3/4"	185K
OPT-DR1272	12"x72"	3/4"	260K
OPT-DR1830	18"x30"	1/2"	120K
OPT-DR1836	18"x36"	1/2"	140K
OPT-DR1842	18"x42"	1/2"	180K
OPT-DR1848	18"x48"	3/4"	200K
OPT-DR1860	18"x60"	3/4"	260K

HALF MOON BURNER



Part Number	Size	HUB	BTU
OPT-HM18	18"x9"	1/2"	80K
OPT-HM24	24"x12"	1/2"	90K
OPT-HM30	30"x15"	1/2"	120K
OPT-HM36	36"x18"	3/4"	140K
OPT-HM42	42"x21"	3/4"	150K
OPT-HM48	48"x24"	3/4"	175K

WATER RING

Male connection



Part Number	Size	HUB
OPT-1008	18"	1/2"
OPT-10000	24"	1/2"
OPT-10030	30"	1/2"
OPT-10001	36"	3/4"
OPT-10002	42"	3/4"
OPT-10003	48"	3/4"

STAINLESS STEEL BURNERS

Our fire burners are individually crafted from 304 stainless steel. Our burner holes are individually drilled, not punched, creating a better flame. Gas inlets are slightly raised to prevent water from entering your gas line. NG or LP compatible. Made in the USA.

LIFETIME WARRANTY ON ALL STAINLESS STEEL BURNERS

RACETRACK SS STEEL BURNER



Part Number	Size	HUB	BTU
OPT-RT618	6"x18"	1/2"	50K
OPT-RT624	6"x24"	1/2"	60K
OPT-RT630	6"x30"	1/2"	70K
OPT-RT636	6"x36"	1/2"	90K
OPT-RT648	6"x48"	1/2"	100K
OPT-RT1224	12"x24"	1/2"	80K
OPT-RT1230	12"x30"	1/2"	90K
OPT-RT1236	12"x36"	1/2"	90K
OPT-RT1242	12"x42"	1/2"	100K
OPT-RT1248	12"x48"	1/2"	180K
OPT-RT1254	12"x54"	3/4"	190K
OPT-RT1260	12"x60"	3/4"	200K
OPT-RT1272	12"x72"	3/4"	240K

DOUBLE RACETRACK SS BURNER



Part Number	Size	HUB	BTU
OPT-DRT1224	12"x24"	1/2"	90K
OPT-DRT1230	12"x30"	1/2"	90K
OPT-DRT1236	12"x36"	1/2"	100K
OPT-DRT1242	12"x42"	1/2"	120K
OPT-DRT1248	12"x48"	3/4"	140K
OPT-DRT1254	12"x54"	3/4"	200K
OPT-DRT1260	12"x60"	3/4"	220K
OPT-DRT1272	12"x72"	3/4"	220K
OPT-DRT1830	18"x30"	3/4"	100K
OPT-DRT1836	18"x36"	3/4"	120K
OPT-DRT1842	18"x42"	3/4"	120K
OPT-DRT1848	18"x48"	3/4"	180K
OPT-DRT1860	18"x60"	3/4"	190K
OPT-DRT1872	18"x72"	3/4"	200K
OPT-DRT1884	18"x84"	3/4"	200K

SWITCH BACK SS BURNER



Part Number	Size	HUB	BTU
OPT-SB18	7"x18"	1/2"	65K
OPT-SB24	7"x24"	1/2"	75K
OPT-SB30	7"x30"	1/2"	90K
OPT-SB36	7"x36"	1/2"	100K
OPT-SB48	7"x48"	1/2"	120K
OPT-SB60	7"x60"	3/4"	160K
OPT-SB72	7"x72"	3/4"	200K
OPT-SB84	7"x84"	3/4"	240K
OPT-SB96	7"x96"	3/4"	280K
OPT-SB108	7"x108"	3/4"	320K
OPT-SB120	7"x120"	3/4"	400K
OPT-SB2412	12"x24"	1/2"	65K
OPT-SB3012	12"x30"	1/2"	75K
OPT-SB3612	12"x36"	1/2"	90K
OPT-SB4812	12"x48"	1/2"	100K
OPT-SB6012	12"x60"	3/4"	120K
OPT-SB7212	12"x72"	3/4"	160K
OPT-SB8412	12"x84"	3/4"	200K
OPT-SB9612	12"x96"	3/4"	240K
OPT-SB10812	12"x108"	3/4"	280K
OPT-SB12012	12"x120"	3/4"	400K

FISH EYE SS BURNER



Part Number	Size	HUB	BTU
OPT-FE18	6"x18"	1/2"	70K
OPT-FE24	6"x24"	1/2"	70K
OPT-FE30	6"x30"	1/2"	90K
OPT-FE36	6"x36"	3/4"	150K
OPT-FE48	6"x48"	3/4"	150K

DOUBLE FISH EYE SS BURNER



Part Number	Size	HUB	BTU
OPT-FE24D	12"x24"	1/2"	100K
OPT-FE36D	12"x36"	1/2"	140K
OPT-FE48D	12"x48"	3/4"	180K
OPT-FE60D	12"x60"	3/4"	200K



Natural Gas Kit
OPT-NGKNG- up to 290K BTU
OPT-NGKNGHC - over 290K BTU
SOLD SEPARATELY



Liquid Propane Kit
OPT-LPKLP - up to 290K BTU
OPT-LPKLPHC - Over 290K BTU
SOLD SEPARATELY

ELECTRONIC IGNITION KITS, GAS KITS, AND OTHER ACCESSORIES FOUND ON PAGES 34-39

STAINLESS STEEL BURNERS

Our fire burners are individually crafted from 304 stainless steel. Our burner holes are individually drilled, not punched, creating a better flame. Gas inlets are slightly raised to prevent water from entering your gas line. NG or LP compatible. Made in the USA.

LIFETIME WARRANTY ON ALL STAINLESS STEEL BURNERS

WHEEL BURNER

Male connection



Part Number	Size	HUB	BTU
OPT-W18	18"	1/2"	125K
OPT-W24	24"	1/2"	150K
OPT-W30	30"	1/2"	200K
OPT-W36	36"	3/4"	220K
OPT-W42	42"	3/4"	260K
OPT-W48	48"	3/4"	300K

STAR BURNER

Male connection



Part Number	Size	HUB	BTU
OPT-171	12"	1/2"	90K
OPT-171A	16"	1/2"	90K
OPT-17118	18"	1/2"	90K
OPT-172	24"	1/2"	150K
OPT-17230	30"	3/4"	200K
OPT-17236	36"	3/4"	300K
OPT-17248	48"	3/4"	300K

LOTUS SS BURNER

Male connection



Part Number	Size	HUB	BTU
OPT-18LTS	18"	1/2"	125K
OPT-24LTS	24"	1/2"	150K
OPT-30LTS	30"	1/2"	200K
OPT-36LTS	36"	3/4"	220K
OPT-42LTS	42"	3/4"	260K
OPT-48LTS	48"	3/4"	300K

S-BURNER



Part Number	Size	HUB	BTU
OPT-3013	6"x18"	1/2"	50K
OPT-3014	6"x24"	1/2"	50K
OPT-301530	6"x30"	1/2"	75K
OPT-3015	6"x36"	1/2"	90K
OPT-3016	6"x48"	1/2"	100K
OPT-301660	6"x60"	3/4"	120K
OPT-3017	6"x72"	3/4"	150K
OPT-301784	6"x84"	3/4"	150K
OPT-301796	6"x96"	3/4"	200K
OPT-3017108	6"x108"	3/4"	200K
OPT-3017120	6"x120"	3/4"	200K

SINGLE RING BURNER

Male connection



Part Number	Size	HUB	BTU
OPT-12SR	12"	1/2"	60K
OPT-18SR	18"	1/2"	70K
OPT-24SR	24"	1/2"	80K
OPT-30SR	30"	1/2"	90K
OPT-36SR	36"	3/4"	90K
OPT-42SR	42"	3/4"	100K
OPT-48SR	48"	3/4"	100K

CUSTOM BURNER STYLES AVAILABLE



ORNAMENTS & SCULPTURES

Each of our ornaments and sculptures are manufactured using high grade stain less steel and mild steel. Each piece is individually hand-crafted which provides great attention to detail and a truly unique fire feature.

SS BURNING BUSH

Male Connection



Part Number	Diameter	Height	Hub	BTU
OPT-BB	16"	18"	1/2"	65k

SS FIRE TREE BURNER

Male Connection

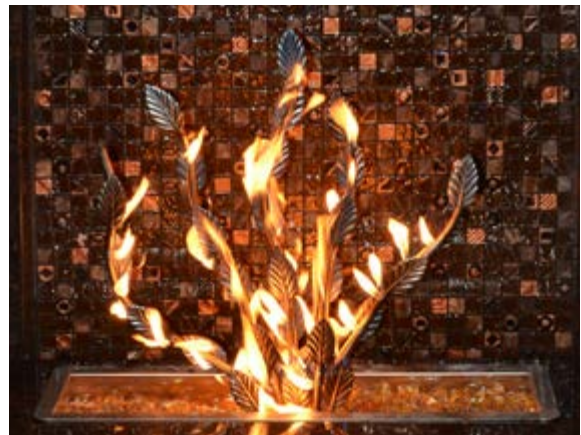

Part Number	Width	Height	Hub	BTU
OPT-3000	24"	24"	1/2"	180k

STEEL FIRE PIT LOGS

Sets over existing burner



Part Number	Diameter	Height
OPT-1924	19"	24"



Natural Gas Kit
 OPT-NGKNG - up to 290K BTU
 OPT-NGKNGHC - over 290K BTU
SOLD SEPARATELY



Liquid Propane Kit
 OPT-LPKLP - up to 290K BTU
 OPT-LPKLPHC - Over 290K BTU
SOLD SEPARATELY

ELECTRONIC IGNITION KITS, GAS KITS, AND OTHER ACCESSORIES FOUND ON PAGES 34-39

ORNAMENTS & SCULPTURES

Each of our ornaments and sculptures are manufactured using high grade stain less steel and mild steel. Each piece is individually hand-crafted which provides great attention to detail and a truly unique fire feature.

SS LOTUS FLOWER BURNER

Male Connection



Part Number	Diameter	Height	Hub	BTU
OPT-LF	18"	9"	1/2"	65k

SS CAT TAIL FIRE PLACE BURNER



Part Number	Width	Depth	Height	Hub	BTU
OPT-18WRF18	18"	6"	18"	1/2"	90K
OPT-18WRF24	24"	6"	18"	1/2"	90K
OPT-18WRF30	30"	6"	18"	1/2"	95K
OPT-18WRF36	36"	6"	18"	1/2"	100K

FIREPLACE LOG AND TRAY SET



Includes: Steel Logs, Steel Grate, Steel Tray and Burner

Part Number	Width	Depth	Height	Hub	BTU
OPT-18SLS	18"	10"	14"	1/2"	90K
OPT-24SLS	24"	10"	14"	1/2"	90K
OPT-30SLS	30"	10"	14"	1/2"	95K
OPT-36SLS	36"	10"	14"	1/2"	100K



ORNAMENTS & SCULPTURES

Each of our ornaments and sculptures are manufactured using high grade stain less steel and mild steel. Each piece is individually hand-crafted which provides great attention to detail and a truly unique fire feature.

SS TANGLED FIREPLACE BURNER



Part Number	Dimensions	Height	Hub	BTU
OPT-TNG24	24" x 8"	8"	1/2"	80K
OPT-TNG30	30" x 8"	8"	1/2"	100K

BIRD'S NEST

Includes burner



Mild Steel



Stainless Steel



36" Stainless Steel Shown Above

Part Number	Diameter	Height	Burner	Hub	BTU
MILD STEEL					
OPT-30BNS	30"	18"	24"	1/2"	150K
OPT-36BNS	36"	18"	24"	1/2"	150K
OPT-48BNS	48"	18"	36"	3/4"	200K
STAINLESS STEEL					
OPT-30BN	30"	18"	24"	1/2"	150K
OPT-36BN	36"	18"	24"	1/2"	150K
OPT-48BN	48"	18"	36"	3/4"	200K

MILLED 1/4" STEEL FIRE TWIGS

Sets over existing burner



Part Number	Dimensions	Height
OPT-STWG24	24" x 10"	18"
OPT-STWG24	30" x 10"	18"



ORNAMENTS & SCULPTURES

Each of our ornaments and sculptures are manufactured using high grade stain less steel and mild steel. Each piece is individually hand-crafted which provides great attention to detail and a truly unique fire feature.

STEEL DESERT STICKS

Sets over existing burner



Part Number	Diameter	Height
OPT-DS	20"	24"

SOLID STEEL LOGS

Sets over existing burner



Part Number	Diameter	Height
OPT-SL	18"	20"

POLISHED SS LOGS

Sets over existing burner



Part Number	Dimensions	Height
OPT-CS2410	24" x 10"	18"
OPT-CS3010	30" x 10"	18"



Natural Gas Kit
 OPT-NGKNG - up to 290K BTU
 OPT-NGKNGHC - over 290K BTU
SOLD SEPARATELY



Liquid Propane Kit
 OPT-LPKLP - up to 290K BTU
 OPT-LPKLPHC - Over 290K BTU
SOLD SEPARATELY

ELECTRONIC IGNITION KITS, GAS KITS, AND OTHER ACCESSORIES FOUND ON PAGES 34-39

ORNAMENTS & SCULPTURES

Each of our ornaments and sculptures are manufactured using high grade stain less steel and mild steel. Each piece is individually hand-crafted which provides great attention to detail and a truly unique fire feature.

BLACK STEEL FIREPLACE WAVES



Part Number	Dimensions	Height	Hub	BTU
OPT-WBB24	24" x 6"	18"	1/2"	80K
OPT-WBB30	30" x 6"	18"	1/2"	100K
OPT-WBB36	36" x 6"	18"	1/2"	120K

STAINLESS STEEL FIREPLACE WAVES



Part Number	Dimensions	Height	Hub	BTU
OPT-WBS24	24" x 6"	18"	1/2"	80K
OPT-WBS30	30" x 6"	18"	1/2"	100K
OPT-WBS36	36" x 6"	18"	1/2"	120K

STEEL UPRIGHT LOGS

Sets over existing burner. Stones not included



Part Number	Dimensions	Height
OPT-STLOG24	24" x 10"	18"
OPT-STLOG30	30" x 10"	18"

	<p>Natural Gas Kit OPT-NGKNG- up to 290K BTU OPT-NGKNGHC - over 290K BTU SOLD SEPARATELY</p>		<p>Liquid Propane Kit OPT-LPKLP - up to 290K BTU OPT-LPKLPHC - Over 290K BTU SOLD SEPARATELY</p>
--	--	--	--

ELECTRONIC IGNITION KITS, GAS KITS, AND OTHER ACCESSORIES FOUND ON PAGES 34-39

ORNAMENTS & SCULPTURES

Each of our ornaments and sculptures are manufactured using high grade stain less steel and mild steel. Each piece is individually hand-crafted which provides great attention to detail and a truly unique fire feature.

STEEL FIRE BALLS

Sets over existing burner.



Steel

Part Number	Diameter	Finish
OPT-FB4	4"	Steel
OPT-FB6	6"	Steel



MILD STEEL HOOPS

Sets over existing burner



Part Number	Dimensions	Height
OPT-STHP24	24" x 16"	18"
OPT-STHP30	30" x 16"	18"



STEEL TRIANGLE SCULPTURE

Sets over existing burner



Part Number	Dimensions	Height
OPT-STTRI24	24" x 14"	22"
OPT-STTRI30	30" x 14"	22"



WATER OVER FIRE INSERT KIT

The Outdoor Plus' Water-Over-Fire Kit is your solution to creating a truly unique fire feature. Its simple construction allows it to drop into place like any other drop in pan, and its plug in play features allows for easy installation and operation. The Water Over Fire Kit is constructed with 304 stainless steel ensuring longevity.

The kits features all components necessary for plug & play operation.

All Water Over Fire Kits are NG or LP compatible.



The water reservoirs requires an 18" clearance below.

Part Number	Diameter	Minimum Cut-out	Height	Flange	Suggested Glass	BTU
OPT-300-WOFKIT-25	25"	25.5"	18"	1"	35	110,000
OPT-300-WOFKIT-31	31"	31.5"	18"	1"	45	130,000
OPT-300-WOFKIT-37	37"	37.5"	18"	1"	55	160,000



READY-TO-FINISH FIRE PIT FORMS

Our Ready-to-Finish forms are pre built, fully assembled fire pits with a raw hardie board finish. This allows you to quickly build a fire pit with your choice of exterior finishing. Match its surroundings or create a truly unique feature, either way the hassle of building a fire pit from scratch is eliminated. Our frames are built from sturdy steel tubing to support any granite or stone finish.

Natural Gas or Liquid Propane applications available. Doors available on taller units. Custom sizes available.

FINISHED PRODUCT EXAMPLES



Because the fire pits come unfinished, you have the liberty to customize it to your preferences, from Ignition Systems, Burners, Burning Media, Ornaments and exterior finishes.

ADDITIONAL OPTIONS



Burning Media



Ornaments



Spark & Automated Ignition



Gas Type - NG or LP

COMPONENT OVERVIEW

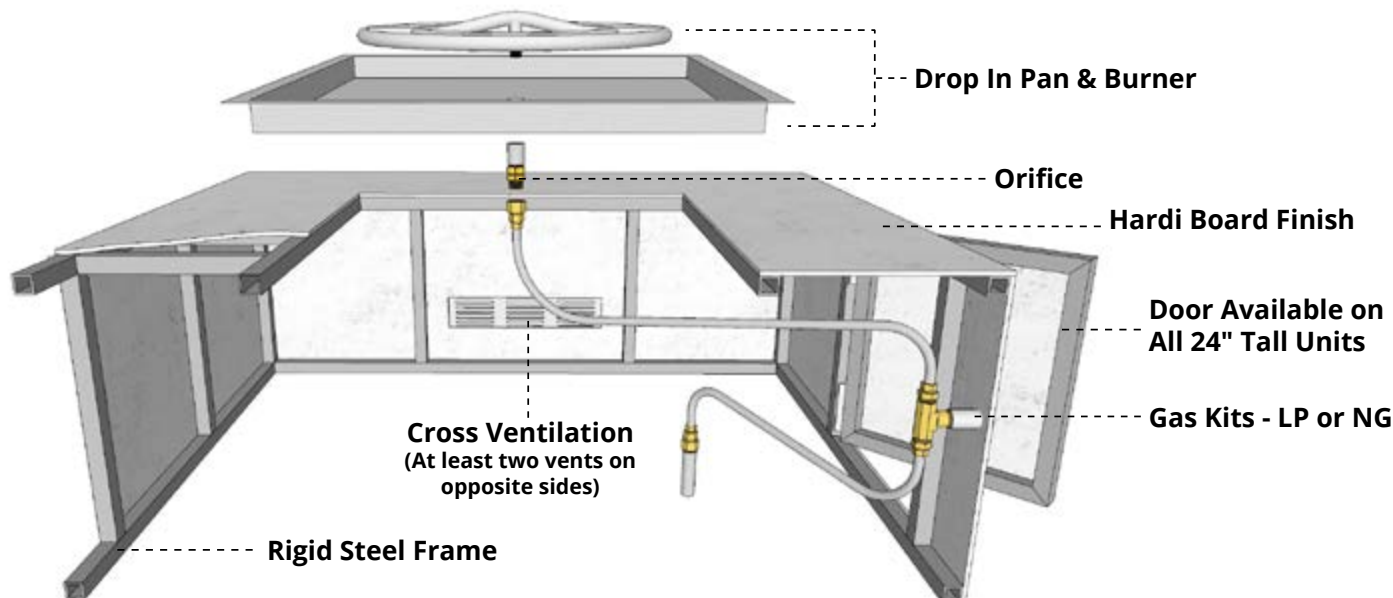

READY-TO-FINISH FORMS

[Click to Return to Table of Contents](#)

All Of The Rtf Forms Come In A Raw Hardy Board Finish. All Units Include: Stainless Steel Drop In Pan, Burner, Key Valve, Whistle Free Hoses And Stainless Steel Air Vent.

Square Pit Form

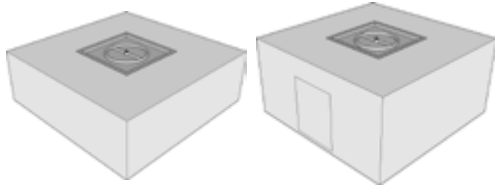

Part Number	Dimension	Height	Pan Size	Burner	Door Size
OPT-S36PB	36"x36"	16"	18"x18"	12"	N/A
OPT-S48PB	48"x48"	16"	24"x24"	18"	N/A
OPT-S60PB	60"x60"	16"	24"x24"	18"	N/A
OPT-S72PB	72"x72"	16"	30"x30"	24"	N/A
OPT-S84PB	84"x84"	16"	36"x36"	24"	N/A
OPT-S36DRPB	36"x36"	24"	18"x18"	12"	14"X17"
OPT-S48DRPB	48"x48"	24"	18"x18"	18"	14"X17"
OPT-S60DRPB	60"x60"	24"	24"x24"	18"	14"X17"
OPT-S72DRPB	72"x72"	24"	30"x30"	24"	14"X17"
OPT-S84DRPB	84"x84"	24"	36"x36"	24"	14"X17"

Square Table Form

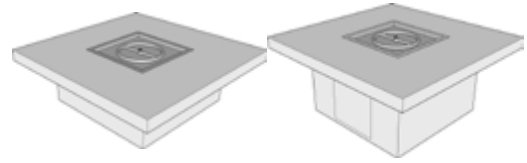

Part Number	Dimension	Height	Pan Size	Burner	Door Size
OPT-ST36PB	36"x36"	16"	18"x18"	12"	N/A
OPT-ST48PB	48"x48"	16"	24"x24"	18"	N/A
OPT-ST60PB	60"x60"	16"	24"x24"	18"	N/A
OPT-ST72PB	72"x72"	16"	30"x30"	24"	N/A
OPT-ST84PB	84"x84"	16"	36"x36"	24"	N/A
OPT-ST36DRPB	36"x36"	24"	18"x18"	12"	14"X17"
OPT-ST48DRPB	48"x48"	24"	24"x24"	18"	14"X17"
OPT-ST60DRPB	60"x60"	24"	24"x24"	18"	14"X17"
OPT-ST72DRPB	72"x72"	24"	30"x30"	24"	14"X17"
OPT-ST84DRPB	84"x84"	24"	36"x36"	24"	14"X17"

Rectangular Pit Form

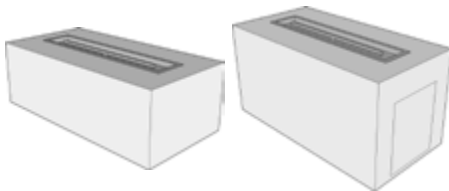

Part Number	Dimension	Height	Pan Size	Burner	Door Size
OPT-UFRT48PB	48"x24"	16"	36"x7"	30"	N/A
OPT-UFRT60PB	60"x24"	16"	36"x7"	30"	N/A
OPT-UFRT72PB	72"x24"	16"	36"x7"	30"	N/A
OPT-UFRT84PB	84"x24"	16"	48"x7"	42"	N/A
OPT-UFRT96PB	96"x24"	16"	48"x7"	42"	N/A
OPT-UFRT108PB	108"x24"	16"	60"x7"	54"	N/A
OPT-UFRT48DRPB	48"x24"	24"	36"x7"	30"	14"X17"
OPT-UFRT60DRPB	60"x24"	24"	36"x7"	30"	14"X17"
OPT-UFRT72DRPB	72"x24"	24"	36"x7"	30"	14"X17"
OPT-UFRT84DRPB	84"x24"	24"	48"x7"	42"	14"X17"
OPT-UFRT96DRPB	96"x24"	24"	48"x7"	42"	14"X17"
OPT-UFRT108DRPB	108"x24"	24"	60"x7"	54"	14"X17"

Rectangular Table Form

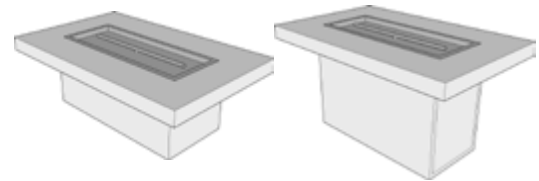

Part Number	Dimension	Height	Pan Size	Burner	Door Size
OPT-URST4816PB	48"x30"	16"	30"x7"	24"	N/A
OPT-URST6016PB	60"x30"	16"	36"x7"	30"	N/A
OPT-URST7216PB	72"x30"	16"	36"x7"	30"	N/A
OPT-URST8416PB	84"x36"	16"	48"x7"	42"	N/A
OPT-URST9616PB	96"x36"	16"	60"x7"	54"	N/A
OPT-URST10816PB	108"x36"	16"	72"x7"	60"	N/A
OPT-URST4816DRPB	48"x30"	24"	30"x7"	30"	14"X17"
OPT-URST6016DRPB	60"x30"	24"	36"x7"	30"	14"X17"
OPT-URST7216DRPB	72"x30"	24"	36"x7"	30"	14"X17"
OPT-URST8416DRPB	84"x36"	24"	48"x7"	42"	14"X17"
OPT-URST9616DRPB	96"x36"	24"	60"x7"	54"	14"X17"
OPT-URST10816DRPB	108"x42"	24"	72"x7"	60"	14"X17"

Round Pit Form

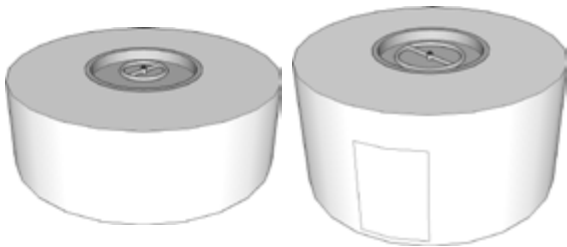

Part Number	Dimension	Height	Pan Size	Burner	Door Size
OPT-RL48PB	48"	16"	19"	12"	N/A
OPT-RL60PB	60"	16"	25"	18"	N/A
OPT-RL72PB	72"	16"	31"	24"	N/A
OPT-RL84PB	84"	16"	37"	30"	N/A
OPT-RL48DRPB	48"	24"	19"	12"	14"X17"
OPT-RL60DRPB	60"	24"	25"	18"	14"X17"
OPT-RL72DRPB	72"	24"	31"	24"	14"X17"
OPT-RL84DRPB	84"	24"	37"	30"	14"X17"

Round Table Form

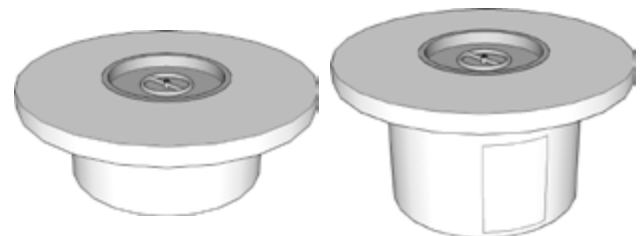

Part Number	Dimension	Height	Pan Size	Burner	Door Size
OPT-RRL48PB	48"	16"	19"	12"	N/A
OPT-RRL60PB	60"	16"	25"	18"	N/A
OPT-RRL72PB	72"	16"	31"	24"	N/A
OPT-RRL84PB	84"	16"	37"	36"	N/A
OPT-RRL48DRPB	48"	24"	19"	12"	14"X17"
OPT-RRL60DRPB	60"	24"	25"	18"	14"X17"
OPT-RRL72DRPB	72"	24"	31"	24"	14"X17"
OPT-RRL84DRPB	84"	24"	37"	36"	14"X17"

READY-TO-FINISH FORMS

[Click to Return to Table of Contents](#)

All Of The Rtf Forms Come In A Raw Hardy Board Finish. All Units Include: Stainless Steel Drop In Pan, Burner, Key Valve, Whistle Free Hoses And Stainless Steel Air Vent.

Catalina Form

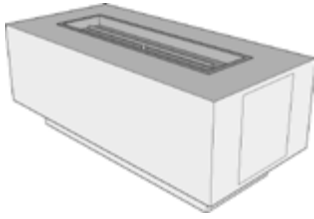

Coronado Form

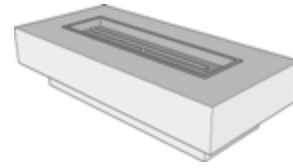

Part Number	Dimension	Height	Pan Size	Burner	Door Size	Part Number	Dimension	Height	Pan Size	Burner
OPT-UCTDR60PB	60"x36"	24"	36"x12"	30"	14"x17"	OPT-UC60PB	60"x28"	15"	42"x10"	36"
OPT-UCTDR72PB	72"x36"	24"	48"x12"	42"	14"x17"	OPT-UC72PB	72"x28"	15"	54"x10"	42"
OPT-UCTDR84PB	84"x36"	24"	60"x12"	54"	14"x17"	OPT-UC84PB	84"x28"	15"	66"x10"	60"
OPT-UCTDR96PB	96"x36"	24"	72"x12"	60"	14"x17"	OPT-UC96PB	96"x28"	15"	78"x10"	72"
OPT-UCTDR108PB	108"x36"	24"	84"x12"	72"	14"x17"	OPT-UC108PB	108"x28"	15"	90"x10"	84"
OPT-UCTDR120PB	120"x36"	24"	96"x12"	84"	14"x17"	OPT-UC120PB	120"x36"	15"	102"x12"	96"

Octagon Pit Form

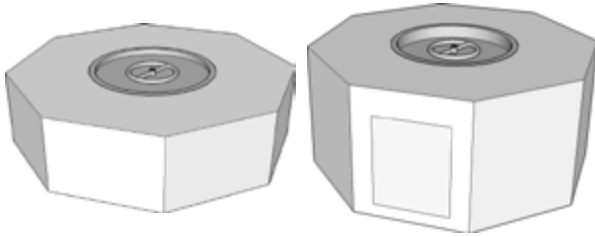

Part Number	Dimension	Height	Pan Size	Burner	Door Size
OPT-OCTG36PB	36"	16"	19"	12"	N/A
OPT-OCTG48PB	48"	16"	19"	12"	N/A
OPT-OCTG60PB	60"	16"	25"	18"	N/A
OPT-OCTG72PB	72"	16"	31"	24"	N/A
OPT-OCTG84PB	84"	16"	37"	30"	N/A
OPT-OCTG36DRPB	36"	24"	19"	12"	14"x17"
OPT-OCTG48DRPB	48"	24"	19"	12"	14"x17"
OPT-OCTG60DRPB	60"	24"	25"	18"	14"x17"
OPT-OCTG72DRPB	72"	24"	31"	24"	14"x17"
OPT-OCTG84DRPB	84"	24"	37"	30"	14"x17"

FIREPIT COVERS

Brushed stainless steel finish. Included stainless steel handle. Suitable for all standard sized fire pit openings

SQUARE COVER



Part Number	Dimensions
OPT-16SC	16" x 16"
OPT-22SC	22" x 22"
OPT-28SC	28" x 28"
OPT-34SC	34" x 34"
OPT-40SC	40" x 40"
OPT-46SC	46" x 46"

Rectangular Cover



Part Number	Dimensions
OPT-RC1028	28" x 10"
OPT-RC1040	40" x 10"
OPT-RC1052	52" x 10"
OPT-RC1064	64" x 10"
OPT-RC1076	76" x 10"
OPT-RC1088	88" x 10"
OPT-RC1628	28" x 16"
OPT-RC1640	40" x 16"
OPT-RC1652	52" x 16"
OPT-RC1664	64" x 16"
OPT-RC1676	76" x 16"
OPT-RC1688	88" x 16"



Black Cone Cover & Heat Reflector

Includes: Mounting Bracket Hook and Black Cone Cover

Part Number	Diameter	Height
OPT-RCB17HRF	17"	48"
OPT-RCB23HRF	23"	48"
OPT-RCB29HRF	29"	48"
OPT-RCB35HRF	35"	48"
OPT-RCB41HRF	41"	48"
OPT-RCB47HRF	47"	48"

Round Cover



Part Number	Diameter
OPT-17RC	17"
OPT-23RC	23"
OPT-29RC	29"
OPT-35RC	35"
OPT-41RC	41"
OPT-47RC	47"

Cone Cover



Part Number	Diameter
OPT-RCB17	17"
OPT-RCB23	23"
OPT-RCB29	29"
OPT-RCB35	35"
OPT-RCB41	41"
OPT-RCB47	47"

ACCESSORIES & GAS KITS

[Click to Return to Table of Contents](#)

Brass Fittings



Part Number	Description
1	OPT-23B 3/8" Male x 1/2" Male
2	OPT-23CC 3/8" Male x 1/2" Female
3	OPT-231 1/2" Female x 1/2" Male
4	OPT-232 1/2" Male x 1/2" Male
5	OPT-23134 3/4" Male x 3/4" Female
6	OPT-23234 3/4" Male x 3/4" Male

Part Number	Description
7	OPT-903812 90° 3/8" Male x 1/2" Female
8	OPT-232A 1/2" Liquid Propane Air Mix
9	OPT-NG012 1/2" Natural Gas Orifice
10	OPT-232AHC 3/4" Liquid Propane Air Mix
11	OPT-NG012HC 3/4" Natural Gas Orifice

Stainless Steel Fittings



Part Number	Description
1	OPT-SSNC 1/2" Coupling
2	OPT-SSN90 1/2" 90° Elbow
3	OPT-SSNT 1/2" T Joint
4	OPT-SSUN 1/2" Union
5	OPT-SSEB 1/2" M To F Elbow
6	OPT-SSN 1/2" Closed Nipple
7	OPT-SSN3 1/2" 3" Long Nipple
8	OPT-SSN6 1/2" 6" Long Nipple

Part Number	Description
1	OPT-SSNC34 3/4" Coupling
2	OPT-SSN9034 3/4" 90° Elbow
3	OPT-SSNT34 3/4" T Joint
4	OPT-SSUN34 3/4" Union
5	OPT-SS2TO3 3/4" To 1/2" Bell Fitting
6	OPT-SSN334 3/4" 3" Long Nipple
7	OPT-SSN634 3/4" 6" Long Nipple

Stainless Steel Whistle Free Gas Hose



Part Number	Description	Length
OPT-245	3/8" Whistle Free Hose	12"
OPT-246	3/8" Whistle Free Hose	18"
OPT-247	3/8" Whistle Free Hose	24"
OPT-248	3/8" Whistle Free Hose	36"
OPT-249	3/8" Whistle Free Hose	48"

Part Number	Description	Length
OPT-238	1/2" Whistle Free Hose	12"
OPT-239	1/2" Whistle Free Hose	18"
OPT-240	1/2" Whistle Free Hose	24"
OPT-241	1/2" Whistle Free Hose	36"
OPT-242	1/2" Whistle Free Hose	48"

High Capacity Stainless Steel Whistle Free Gas Hose



Part Number	Description	Length
OPT-248HC	3/4" Whistle Free Hose	36"

ACCESSORIES & GAS KITS

[Click to Return to Table of Contents](#)



OPT-256
1/2" Brass Key Valve



OPT-NGBV
1/2" Ball Valve



OPT-25634
3/4" Full Flow Ball Valve



OPT-35690
3/4" Full Flow Ball Valve
with 90° Bend



OPT-1300
LP Hose & Regulator - 37"



OPT-1321HP
High Pressure LP Hose - 8'



OPT-256FF
1/2" Full Flow Ball Valve



OPT-259FF
1/2" Full Flow Ball Valve
with 90° Bend



Natural Gas Kits

OPT-NGKNG
Natural Gas Kit
24" 1/2" Whistle Free Hoses,
Key Valve, Key

OPT-NGKNGHC
High Capacity Natural Gas Kit
36" 3/4" Whistle Free Hoses,
Full Flow Key Valve, Key



Liquid Propane Kits

OPT-LPKLP
Liquid Propane Kit
Propane Regulator, Whistle Free
Hose, Key Valve, Key

OPT-LPKLPHC
High Pressure Liquid Propane Kit
High Pressure Propane Regulator,
Whistle Free Hose, Full Flow Key Valve, Key



Replacement Turn Keys

OPT-RKV
4" Turn Key

OPT-RKV8
8" Turn Key

OPT-RKV11
11" Turn Key

OPT-RKV16
16" Turn Key

OPT-RKV22
22" Turn Key

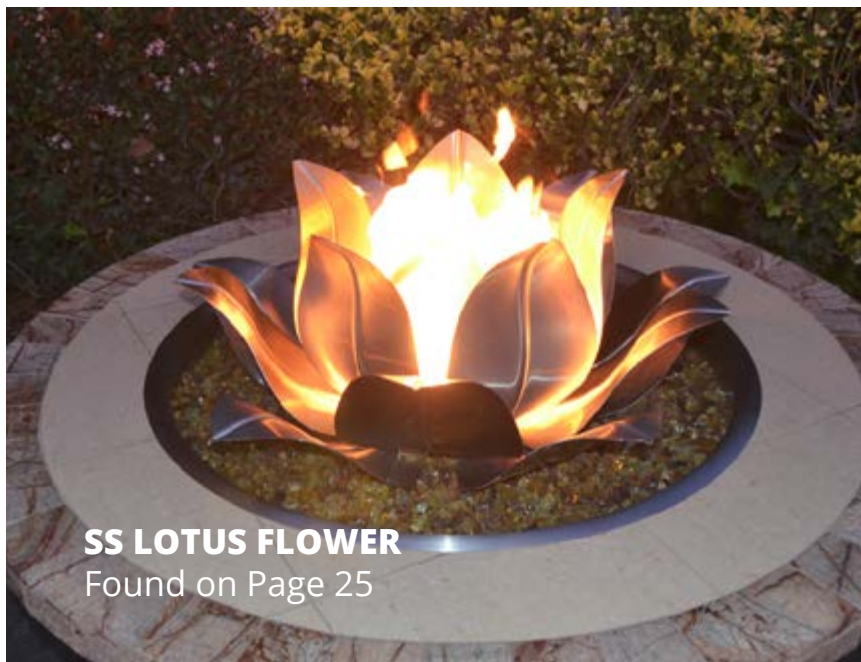

SS LOTUS FLOWER
Found on Page 25

GAS KIT DIAGRAMS

LP KIT DIAGRAM

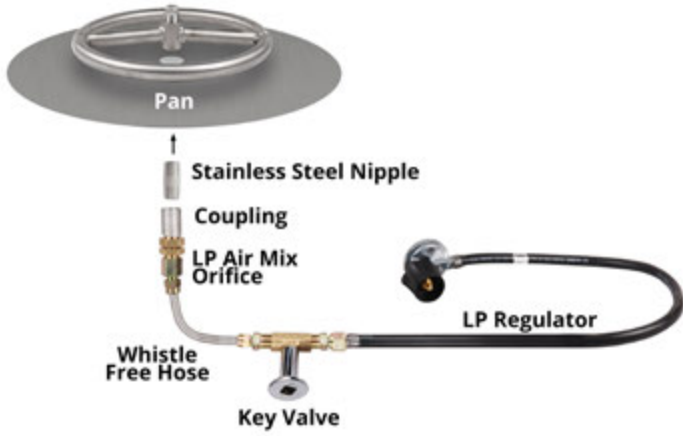

NG KIT DIAGRAM

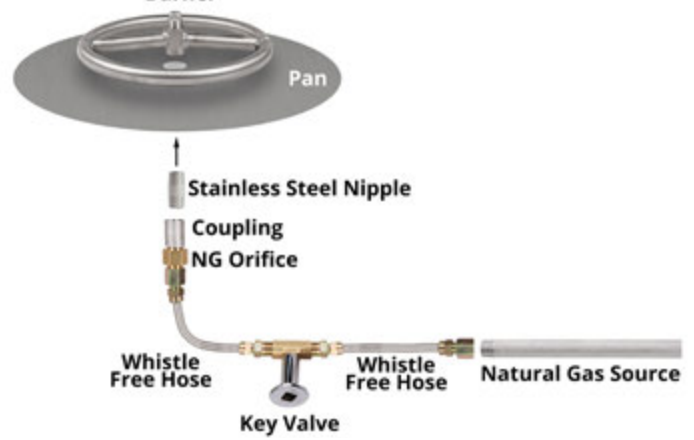

ACCESSORIES & GAS KITS

[Click to Return to Table of Contents](#)



Push Igniter Kit - Liquid Propane

OPT-2322LP

OPT-2322LPHC - Applications over 290,000 BTUs

Includes: Mounting plate, Push Button Ignition, Push Button Electrical Leads, Brass Key Valve, Turn Key, 3/8" SS Whistle Free Hose - 30", LP Hose and Regulator, Spark Igniter Cover, Brass Air Mixer



Push Igniter Kit - Natural Gas

OPT-2322NG

OPT-2322NGHC - Applications over 290,000 BTUs

Includes: Mounting plate, Push Button Ignition, Push Button Electrical Leads, Brass Key Valve, Turn Key, 1/2" SS Whistle Free Hoses - 36", Spark Igniter Cover



OPT-SIPB

Push Button Retro Kit - Push Button & Electrode with 36" Leads



OPT-RPB

Push Button Only



OPT-P36

Electrode with 36" Leads



OPT-PIC

Push Button Electrode Cover



Electrical Emergency Shut-Off Button

OPT-ESTOP

Outdoor rated electrical box and cover
Suited for 110V



Electrical Dial Timer

OPT-DTM

2-Hours max
Outdoor rated electrical box
Pre-Suited for 110V wiring



NG Regulator

OPT-1300NGR

1/2" female inlets
CSA certified
Max inlet pressure: 1/2 PSI



3 Hour Gas Timer

OPT-TO

Includes timer and (2) nipples
1/2" Female Inlets
Max BTUs: 100,000
Max Temp: 125°



3 Hour Gas Timer and Mounting Plate

OPT-TP

Includes (2) M to F 90° elbows, & (4) self-tapping ss screws
1/2" Female Inlets
Max BTUs: 100,000
Max Temp: 125°



1 Hour Gas Timer and Lock Box

OPT-TBL

Includes (2) M to F 90° elbows and (4) self-tapping ss screws
1/2" Female Inlets
Max BTUs: 100,000
Max Temp: 125°

PUSH BUTTON IGNITION DIAGRAM

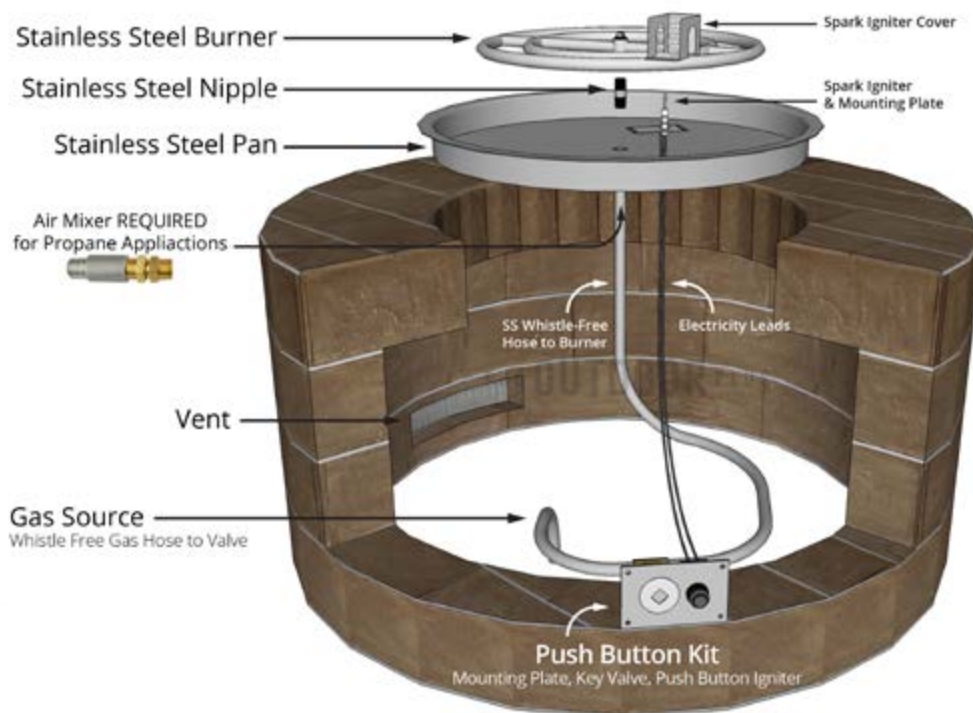

ELECTRONIC IGNITION DIAGRAM

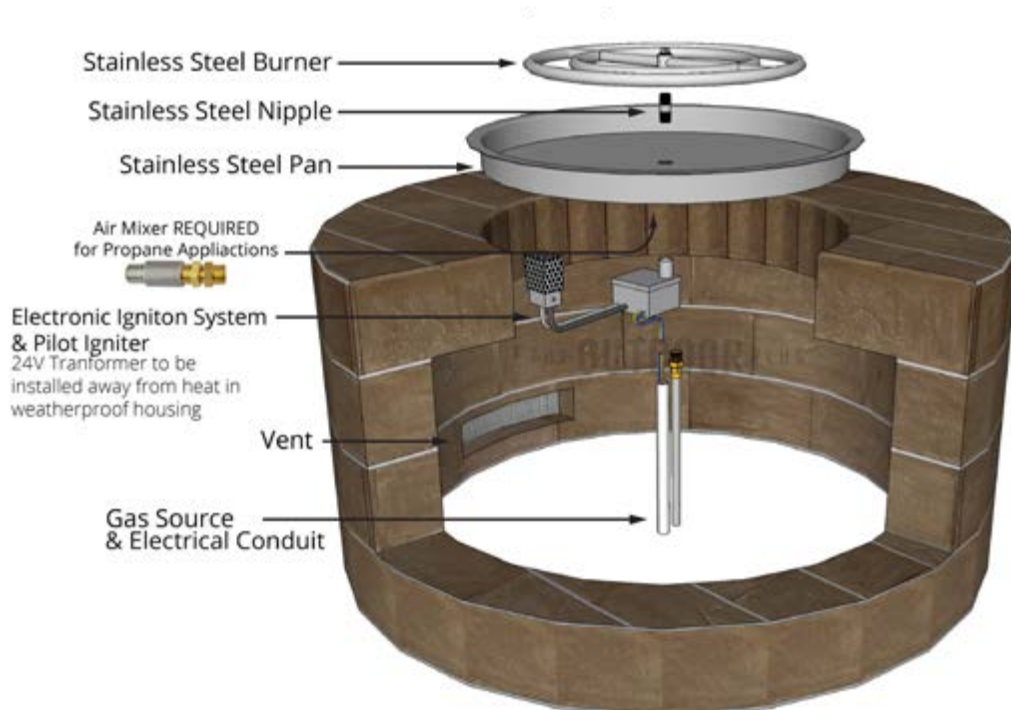



Electronic Ignition Systems **MUST** be installed by a certified electrician. Installation by an uncertified professional will automatically void warranty



For proper operation, ensure the top of the PILOT remains uncovered

BURNER IS EXPOSED FOR ILLUSTRATION PURPOSES ONLY

FUEL TYPE

- » Before making gas connections, ensure appliance being installed is compatible with the available gas type. Check label on appliance to confirm appliance gas type requirement

GAS PRESSURE

- » Proper input gas pressure is required for optimum appliance performance

ELECTRICAL REQUIREMENTS

- » The Electronic Ignition System operates on 24 Volts AC OR 12 Volts AC power

CLEARANCE FROM COMBUSTIBLES

- » Provide adequate clearance form combustibles (See diagram Pg. 47)

Functions With:

- On/Off Switch
- Remote Controller
- Pool Remote
- Home Automated System

KEY FEATURES

- » Tested at 55 mph wind & will reignite if blown out
- » Tested in rain & snow
- » Small and compact
- » CSA Certified
- » Control by pool controller / remote control / switch or home automated systems
- » 3 different units for different BTU outputs
- » 1 year warranty
- » 12V AC POWER ONLY
- » Glow Plug Igniter
- » 24V Transformers compatible with 110V

PROPERLY INSTALLED ELECTRONIC IGNITION SYSTEM

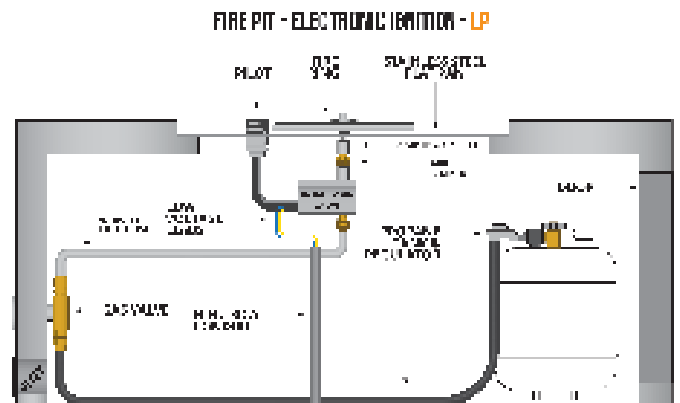
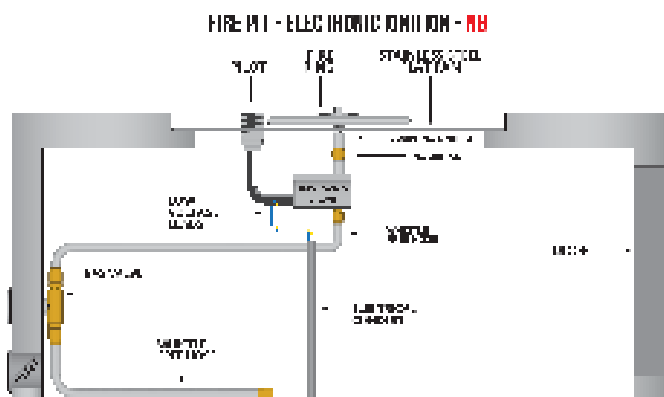

FIRE & WATER UNIT - AUTOMATED IGNITION

JERSERY CITY



CERTIFIED ELECTRONIC IGNITION SYSTEMS

REMOTE CONTROL SYSTEM ADD-ON

Pair with our Electronic Ignition System for a hands free ignition



Remote Control System - 12V

OPT-400-XREMOTE-12V

Outdoor Rated Box
Suited for 110V
Includes remote, Receiver, Mounted switch and 12V Transformer

Remote Control System

OPT-400-XREMOTE

Outdoor Rated Box
Suited for 110V
Includes remote, Receiver, Mounted switch and 24V Transformer

INDIVIDUAL REPLACEMENT COMPONENTS



Pilot Igniter
OPT-PIR
Length: 18"



Commercial Grade Pilot Igniter
OPT-PIRCG
Length: 18"



Replacement Control
OPT-XRM



12VAC Control Panel
OPT-12V



Pilot Igniter Extensions

Compatible with all Electronic Systems

- 12" Pilot Extension - OPT-PE12
- 36" Pilot Extension - OPT-PE36
- 60" Pilot Extension - OPT-PE60
- 96" Pilot Extension - OPT-PE96



24V Transformer
OPT-24V

Glass comes in 25lb bags. Lava chunks come in 1 cubic foot quantity. Polished lava comes in ½ cubic foot quantity. The Outdoor Plus' selection of burning media is perfect for any fire pit, fire bowl or fireplace. All options are suitable for any type of fire. We suggest covering the burner a maximum of 1 inch. **Note:** using media that is not fire rated can be hazardous. Using media that is not sufficiently porous may retain moisture. This moisture can expand with heat and pieces can pop and be hazardous. Fire media is not intended for units used for cooking or grilling.



Black ½"-¾"
OPT-701



Turquoise ½"-¾"
OPT-706



Blue ½"-¾"
OPT-702



Amber ½"-¾"
OPT-708



Lava Chunks - 1"
OPT-150-50



¼" Black Reflective
OPT-144BL



¼" Copper Reflective
OPT-138C

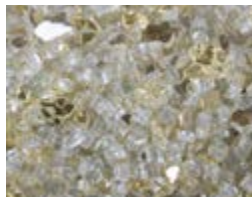

¼" Gold Reflective
OPT-144GL

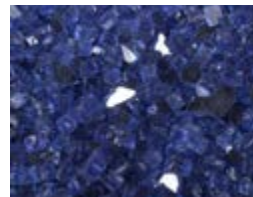

¼" Cobalt Reflective
OPT-144CB



Polished Lava 2"-3"
OPT-PL-50

How Much Glass Do I Need?

Use this table to decide how much glass you will need for your fire feature. These amounts are for units with a burning area depth of 2".

ROUND - 2" DEEP

Diameter	Amount
13"	15 lbs.
19"	30 lbs.
25"	50 lbs.
31"	80 lbs.
37"	125 lbs.
43"	160 lbs.

SQUARE- 2" DEEP

Size	Amount
16.5"	15 lbs.
18"	30 lbs.
24"	50 lbs.
30"	80 lbs.
36"	125 lbs.
48"	160 lbs.

RECTANGULAR - 2" DEEP

Length	Width	Amount
24"	6"	17 lbs.
30"	6"	21 lbs.
36"	6"	25 lbs.
42"	6"	29 lbs.
48"	6"	34 lbs.
60"	6"	42 lbs.
72"	6"	50 lbs.
84"	6"	59 lbs.
96"	6"	67 lbs.
24"	12"	34 lbs.
30"	12"	42 lbs.
36"	12"	50 lbs.
42"	12"	58 lbs.
48"	12"	68 lbs.
60"	12"	84 lbs.
72"	12"	100 lbs.
84"	12"	118 lbs.
96"	12"	134 lbs.
24"	18"	50 lbs.
30"	18"	63 lbs.
36"	18"	76 lbs.
42"	18"	88 lbs.
48"	18"	100 lbs.
60"	18"	126 lbs.
72"	18"	151 lbs.
84"	18"	177 lbs.
96"	18"	200 lbs.



CUSTOM WIND GUARDS

[Click to Return to Table of Contents](#)



GLASS WIND GUARDS

Glass Wind Guards are available in square and rectangular shapes. They can be custom made to any height & dimensions needed. Assembled from 1/4" tempered polish glass & chrome connectors.

STEEL FLAME GUARDS

Steel Flame Guards can be custom built to any size and any style needed.



T.O.P. can manufacture any size or style needed!

STAINLESS STEEL FLAME GUARDS

Custom Stainless Steel Flame Guards are available in any shape and any size. Built from 304 stainless steel perforated material, these are guaranteed to withstand the heat and nature's elements.



LIMITED WARRANTY

The Outdoor Plus Company (TOP) warranties fire pits against manufacturing defects that prevent safe and correct function as follows:

- Electronics, Gas Valves, & Pilot Assembly: 1 year
- Stainless steel Burners & Brass Burners: Lifetime Warranty
- Stainless Steel Pan, & Valve Box: Commercial - 1 year; Residential - 3 years

This commences from the date of original sale / shipment from The Outdoor Plus

This warranty is for the parts and in-house (TOP) labor. The defective product must be sent back to TOP with a Return Merchandise Authorization (RMA) issued by TOP for that specific product and any other additional information for the nature of the defect or warrant claim

The warranty does not cover items that have been damaged by overheating, modification, abuse, or improper storage.

Any labor involving installation or maintenance with the unit is not covered

This warranty excludes claims for consequential, indirect-collateral expenses arising from the products defects or warranty recovery

This warranty is only applied to original purchases.

PRODUCT RETURN POLICY

No returns on made-to-order goods.

No returns on custom features, NO EXCEPTIONS.

If a product is delivered incorrectly, it is the recipients responsibility to notify TOP within 48 hours. TOP is not responsible for incorrect or damaged packages and shipments 48 hours after they have been received.

PRODUCT TESTING PROGRAM

If you believe a unit or component you received is defective, The Outdoor Plus will gladly test any component at our facility. TOP will cover shipping back to you.

DEFECTIVE: If an item is found to be defective it will be repaired or replaced at our discretion. TOP will absorb all costs of outgoing freight and replacement or repair costs if product is in warranty.

NON-DEFECTIVE: If the product is found to be non-defective it will be returned to the customer - no credit will be given. Freight coming in are at the customers expense.

TOP ERROR: If a return is needed due to a mistake on our part, we will issue a RMA and Return Services Label. When products are received at TOP, credit will be issued for the products and the outgoing freight on the original invoice.

CUSTOMER ERROR: If an RMA is asked for and covers current new products in the original package, we will authorize the return. The customer is responsible for the return shipping. When products are received we will issue credit for the original customer cost less a 25% restocking charge.

Custom orders do not apply.

PRODUCT WARRANTY

The Outdoor Plus, Inc., warranties product against manufacturing defects that prevent safe and correct operation of the product commencing from the date of original sale or shipment from TOP. The warranty on parts and in-house labor will apply only to claims presented to us by our original customer and is in lieu of all other warranties expressed or implied. Please refer to the Warranty Chart below for warranty periods.

The defective product must be shipped back with an RMA (Return Merchandise Authorization) issued by TOP for that specific product which states the nature of the defect or warranty claim. Product to be returned should be packed carefully- The Outdoor Plus is not responsible for shipping damage on returned items. The original purchase information will be required. RMA's are only valid for 30 days from the date of issue by TOP and will not be processed if received after the expiration date. The RMA number must be indicated on the outside of the return package and a copy of the RMA should be placed in the package with product.

Our warranty does not cover items that have been damaged by overheating, modification, abuse, improper storage, installation, or maintenance . This warranty excludes claims for incidental or consequential damage and indirect collateral expenses arising from product defects or warranty recovery. Product manufactured by TOP cannot be altered or modified in any way.

The Outdoor Plus is not responsible for local codes and will not accept a return on any product that is not approved for installation. Please check with your local authorities or governing agencies for proper approvals before purchasing. TOP is not responsible for the actions including negligence of the installer.

FREIGHT POLICY

Most orders will be shipped FOB Ontario, California, with a standard shipping carrier selected by TOP unless customer specifically requests their own carrier and account. A freight quote may be requested in advance. TOP works diligently with standard carriers to achieve the best discounts available.

MINIMUM ADVERTISED PRICING POLICY

The Outdoor Plus Inc. unilaterally applies this Minimum Advertised Pricing Policy. This Policy is subject to change at any time by the Company at its sole discretion.

1. **PURPOSE:** The purpose of this policy is to protect the value of the Company's trademarks and brand names and to attract and retain reputable, customer-friendly vendors, brick & mortar and online.

2. **SCOPE:** This Policy is applicable to all sellers of the Company's products who advertise or sell Products on any Internet platform and to distributors that sell to such resellers. This Policy applies to all products of TOP unless otherwise specified by TOP. The Policy applies only to prices advertised anywhere on the Internet or by means of the Internet (including

but not limited to websites, social media, direct e-mail advertising, and related materials that are accessible through the Internet platform by means of a hyperlink). The Policy does not apply to print advertising or in-store advertising for products to be sold at a physical store but does apply to all advertising for sales to be made over or by means of the Internet. This policy does not apply to the price at which the products are actually sold. Nothing in the Policy or other agreement with the Company will constitute an agreement on the price or price levels at which Resellers or Distributors actually sell any Product.

3. **INTERNET MINIMUM ADVERTISED PRICE:** The Internet advertised price of a Product means the net price advertised on the Internet after all discounts, rebates, gifts or promotional items. The Internet Minimum Advertised Price ("MAP") shall be set by the Company from time to time in its sole discretion and shall be communicated by the Company to the Resellers from time to time. If the Company makes the MAP available on a website accessible to the Reseller and informs Reseller of this, it is the responsibility of the Reseller to maintain current knowledge of the MAP.

4. **POLICY ON INTERNET PRICE ADVERTISING:** It is the policy of the Company that Resellers shall not advertise any Company Product on the Internet at prices below the MAP for that Product established by the Company. This policy is not violated by Reseller advertising a higher price. Also, this policy is not violated by communication by email or telephone to an individual customer in response to a telephone or email inquiry from the customer. Statements on a website such as "call for pricing" for a Product do not violate the Policy as long as a price for the Product is provided on the same website and that price is equal to or exceeds the MAP. Also, it is a violation of this Policy for the Reseller to characterize or disclose any pricing as the Internet minimum advertised price or that such minimum is based on the Company's policies. Resellers and Distributors have not agreed to this unilateral Policy and the Company is not seeking any such agreement. However, if a Reseller or a Distributor violates this Policy, the Company's policy is to take certain unilateral actions.

5. **ACTIONS BY THE COMPANY:** The Company has the right to sell Products to each Reseller or Distributor or to refrain or stop from doing in its discretion for any reason or for no reason. Under this Policy, if Reseller advertises Products on the Internet below the MAP or otherwise violates this Policy, the Company may cease selling or shipping Products to Reseller or its customers and/or cease taking orders from Reseller for a temporary or permanent period in the Company's discretion, which may take into account circumstances such as the number of violations or the repetition of violations. Also, if a Distributor sells Product to any Reseller that violates this Policy, the Distributor will be in violation of the Policy and the Company may cease selling or shipping Products to that Distributor or its customers and/or cease taking orders from that Distributor for a temporary or permanent period in the Company's discretion, which may take into account circumstances such as the number of violations or the repetition of violations. The Company will take these actions unilaterally and will not seek or accept any agreement by a Reseller or a Distributor or any assurance of future compliance by that Reseller or Distributor.

6. **CONTACT INFORMATION:** Company sales personnel have

no authority to modify or grant exceptions to this Policy. All questions or comments regarding this Policy should be directed to the policy administrator at sales@theoutdoorplus.com

THE OUTDOOR PLUS PHOTOGRAPHY PROGRAM

Here at The Outdoor Plus we are always looking for the best images and photography that represents our products and the lifestyle around it. Finished an installation that uses our products that you are proud of? Send us your images! Most DSLR cameras or high end smart phones will work! (Samsung Galaxy S6 or newer. iPhone 6 or newer)

Images requirements: Must be larger than 1000 x 1000 pixels. Must be high resolution.

Not sure if your photos meet these requirements? Send them to us and our in house media adviser will advise you. If your images are approved, you will receive \$100 - \$150 credit for any future purchases. Send Pictures with: Your name, company name, phone number, Purchase Order # or Sales Order # to SALES@THEOUTDOORPLUS.COM. Help us promote your work with our amazing products. We look forward to your submissions.



TOPFIRES

BY THE OUTDOOR PLUS



METALLIC & RUSTIC PREMIUM FINISHES

Metallic Finishes

TOP Fire's metallic finishes are the latest additions to the concrete finish options. Each finish reflects beautifully in the light and mimics the look of an anodized finish. Our metallic finishes can be applied to ANY GFRC concrete product. This means you can have any concrete bowl, fire pit or fire table in a luxurious metallic finish



Slate
-MSL



Pearl
-MPR



Silver
-MSV



Bronze
-MBR



Copper
-MCP

Rustic Finishes

TOP Fire's rustic finishes are some of the latest additions to concrete finish options. The texture is created by hand, creating a unique finish every time. The textured appearance is only on the surface. This means your fire pit will still be extremely strong. Every concrete bowl, fire pit or fire table can be made with the rustic finish

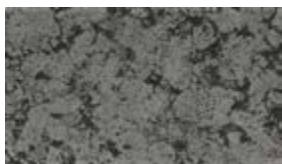

Rustic Gray
-RGR



Moss
-RMS



Rustic Limestone
-RWH



Coffee
-RCF

ROMA CONCRETE BOWLS

Roma Planter

Includes: Bowl (Soil and plants not included.)

SKU	SIZE	BASE	HEIGHT	SOIL USAGE
OPT-ROMPO24	24"	13"	10"	1 ft ³
OPT-ROMPO37	37"	16"	17"	3 ft ³



Roma Planter & Water Bowl

Includes: Bowl, Copper Scupper (¾" Scupper). (Soil and plants not included)

SKU	SIZE	BASE	HEIGHT	GPM	SOIL USAGE
OPT-ROMPW24	24"	13"	10"	12-15	1 ft ³
OPT-ROMPW37	37"	16"	17"	12-15	3 ft ³



Roma Water Bowl

Includes: Bowl, Smooth Flow Water Fitting (1 ½" Connection) & Copper Scupper

SKU	SIZE	BASE	HEIGHT	GPM
OPT-ROMWO24	24"	13"	10"	12-15
OPT-ROMWO37	37"	16"	17"	12-15

Roma Fire Bowl



Includes: CSA Certified 12VAC Electronic Ignition System; Bowl, Fire Plate, Burner, Gas Line, LP or NG Orifice, Mounting Bracket & Lava Rock.

SKU	IGNITION	SIZE	BASE	HEIGHT	BURNER	BTU	SUGG. GLASS
OPT-ROM24	Match Lit	24"	13"	10"	8"	65,000	25 lbs
OPT-ROM37	Match Lit	37"	16"	17"	12"	65,000	75 lbs
OPT-ROM24E12V	Electronic	24"	13"	10"	8"	65,000	25 lbs
OPT-ROM37E12V	Electronic	37"	16"	17"	12"	65,000	75 lbs



Roma Fire & Water Bowl



Includes: CSA Certified 12VAC Electronic Ignition System; Bowl, Fire Plate, Burner, Gas Line, LP or NG Orifice, Copper Scupper, Mounting Bracket & Lava Rock.

SKU	IGNITION	SIZE	BASE	HEIGHT	BURNER	BTU	SUGG. GLASS	GPM
OPT-ROMFW24	Match Lit	24"	13"	10"	8"	65,000	50 lbs.	12-15
OPT-ROMFW37	Match Lit	37"	16"	17"	12"	65,000	75 lbs.	12-15
OPT-ROMFW24E12V	Electronic	24"	13"	10"	8"	65,000	50 lbs.	12-15
OPT-ROMFW37E12V	Electronic	37"	16"	17"	12"	65,000	75 lbs.	12-15

The Outdoor Plus individually handcrafts all of the products shown here. Finishes are subject to slight texture/color variations.

SEDONA CONCRETE BOWLS



Sedona Planter Bowl

Includes: Bowl (Soil and plants not included.)

SKU	SIZE	BASE	HEIGHT	SOIL USAGE
OPT-27RP	27"	12"	10"	1.5 ft ³
OPT-33RP	33"	17"	11"	2.5 ft ³

Sedona Planter & Water Bowl

Includes: Bowl, Copper Scupper (3/4" Scupper). (Soil and plants not included)

SKU	SIZE	BASE	HEIGHT	SOIL USAGE	GPM
OPT-27RPW	27"	12"	10"	1.5 ft ³	12-15
OPT-33RPW	33"	17"	11"	2.5 ft ³	12-15



Sedona Water Bowl

Includes: Bowl, Smooth Flow Water Fitting (1 1/2" Connection) & Copper Scupper

SKU	SIZE	BASE	HEIGHT	GPM
OPT-27RWO	27"	12"	10"	12-15
OPT-33RWO	33"	17"	11"	12-15



All Water Bowls Include The Easy Flow Fitting

All Water Bowls come with our easy-flow water fitting that accommodates a 1 1/2" water line



Mounted Key Valve Upgrade OPT-KVI

Installed Onto Bowl: Key Valve, Installation Bracket, & Gas Hoses

The Outdoor Plus individually handcrafts all of the products shown here. Finishes are subject to slight texture/color variations. Metallic Finishes and Rustic Finishes are available at an extra charge

When ordering, specify the concrete color by adding the color code to the end of the part number. Example: 24" Black Maya Water Bowl = OPT-24SWO-BLK

Black -BLK	Ash -ASH	Natural Gray -NGY	Gray -GRY	White Limestone -LIM	Chocolate -CHC	Chestnut -CST	Brown -BRN	Vanilla -VAN
Rustic Gray -RGR	Moss Stone -RMS	Rustic White -RWH	Coffee -RCF	Slate -MSL	Silver -MSV	Pearl -MPR	Bronze -MBR	Copper -MCP

SEDONA CONCRETE BOWLS



Sedona Fire Bowl

Includes: CSA Certified 12VAC Electronic Ignition System; Bowl, Fire Plate, Burner, Gas Line, LP or NG Orifice, Mounting Bracket & Lava Rock.



SKU	IGNITION	SIZE	BASE	HEIGHT	BURNER	BTU	SUGG. GLASS
OPT-27RFO	Match Lit	27"	12"	10"	8"	65,000	50 lbs.
OPT-33RFO	Match Lit	33"	17"	11"	12"	65,000	75 lbs.
OPT-27RFOE12V	Electronic	27"	12"	10"	8"	65,000	50 lbs.
OPT-33RFOE12V	Electronic	33"	17"	11"	12"	90,000	75 lbs.

Sedona Fire & Water Bowl



Includes: CSA Certified 12VAC Electronic Ignition System; Bowl, Fire Plate, Burner, Gas Line, LP or NG Orifice, Copper Scupper, Mounting Bracket & Lava Rock.



SKU	IGNITION	SIZE	BASE	HEIGHT	BURNER	BTU	SUGG. GLASS	GPM
OPT-27RFWM	Match Lit	27"	12"	10"	8"	65,000	50 lbs.	12-15
OPT-33RFWM	Match Lit	33"	17"	11"	12"	65,000	75 lbs.	12-15
OPT-27RFWE12V	Electronic	27"	12"	10"	8"	65,000	50 lbs.	12-15
OPT-33RFWE12V	Electronic	33"	17"	11"	12"	65,000	75 lbs.	12-15



Sedona 360° Fire & Water Bowl



Includes: CSA Certified 12VAC Electronic Ignition System; Bowl, Fire Plate, Burner, Gas Line, LP or NG Orifice, Mounting Bracket & Lava Rock.



SKU	IGNITION	SIZE	BURN AREA	BASE	HEIGHT	BURNER	BTU	SUGG. GLASS	GPM
OPT-38FW360	Match Lit	38"	14"	18"	16"	8"	65,000	25 lbs.	40-50
OPT-38FW360E12V	Electronic	38"	14"	18"	16"	8"	65,000	25 lbs.	40-50



33" Brown Sedona Water Bowl



33" Brown Sedona Fire & Water Bowl

The Outdoor Plus individually handcrafts all of the products shown here. Finishes are subject to slight texture/color variations.

LUNA CONCRETE BOWLS



Luna Planter Bowl

Includes: Bowl (Soil and plants not included.)

SKU	SIZE	BASE	HEIGHT	SOIL USAGE
OPT-LUNPO30	30"	13"	15"	3 ft ³
OPT-LUNPO38	38"	16.5"	16.5"	5.75 ft ³

Luna Planter & Water Bowl

Includes: Bowl, Copper Scupper (¾" Scupper). (Soil and plants not included)

SKU	SIZE	BASE	HEIGHT	GPM	SOIL USAGE
OPT-LUNPW30	30"	13"	15"	12-15	3 ft ³
OPT-LUNPW38	38"	16.5"	16.5"	12-15	5.75 ft ³

The Outdoor Plus individually handcrafts all of the products shown here. Finishes are subject to slight texture/color variations.

LUNA CONCRETE BOWLS



Luna Water Bowl



Includes: Bowl, Smooth Flow Water Fitting (1 1/2" Connection) & Copper Scupper

SKU	SIZE	BASE	HEIGHT	GPM
OPT-LUNWO30	30"	13"	15"	12-15

Luna Fire Bowl



Includes: CSA Certified 12VAC Electronic Ignition System; Bowl, Fire Plate, Burner, Gas Line, LP or NG Orifice, Mounting Bracket & Lava Rock.



SKU	IGNITION	SIZE	BASE	HEIGHT	BURNER	BTU	SUGG. GLASS
OPT-LUNFO30	Match Lit	30"	13"	15"	12"	65,000	50 lbs.
OPT-LUNFO38	Match Lit	38"	13"	16.5"	18"	65,000	75 lbs.
 OPT-LUNFO30E12V	Electronic	30"	13"	15"	12"	65,000	50 lbs.
 OPT-LUNFO38E12V	Electronic	38"	13"	16.5"	18"	65,000	75 lbs.



Luna Fire & Water Bowl



Includes: CSA Certified 12VAC Electronic Ignition System; Bowl, Fire Plate, Burner, Gas Line, LP or NG Orifice, Copper Scupper, Mounting Bracket & Lava Rock.

SKU	IGNITION	SIZE	BASE	HEIGHT	BURNER	BTU	GPM	SUGG. GLASS
OPT-LUNFW30	Match Lit	30"	13"	15"	12"	65,000	12-15	50 lbs.
OPT-LUNFW38	Match Lit	38"	16.5"	16.5"	18"	65,000	12-15	75 lbs.
 OPT-LUN30FWE12V	Electronic	30"	13"	15"	12"	65,000	12-15	50 lbs.
 OPT-LUN38FWE12V	Electronic	38"	13"	16.5"	18"	65,000	12-15	75 lbs.

The Outdoor Plus individually handcrafts all of the products shown here. Finishes are subject to slight texture/color variations.

CAZO CONCRETE BOWLS



Cazo Planter Bowl

Includes: Bowl (Soil and plants not included.)

SKU	SIZE	BASE	HEIGHT	SOIL USAGE
OPT-24RP	24"	9"	8"	1 ft ³
OPT-31RP	31"	12"	10"	2 ft ³
OPT-36RP	36"	20"	10"	3 ft ³

Cazo Planter & WaterBowl

Includes: Bowl, Copper Scupper (3/4" Scupper).
(Soil and plants not included)

SKU	SIZE	BASE	HEIGHT	SOIL USAGE	GPM
OPT-24RPW	24"	9"	8"	1 ft ³	12-15
OPT-31RPW	31"	12"	10"	2 ft ³	12-15
OPT-36RPW	36"	20"	10"	3 ft ³	12-15



Cazo Water Bowl

Includes: Bowl, Smooth Flow Water Fitting (1 1/2" Connection) & Copper Scupper

SKU	SIZE	BASE	HEIGHT	GPM
OPT-24RWO	24"	9"	8"	12-15
OPT-31RWO	31"	12"	10"	12-15
OPT-36RWO	36"	20"	10"	12-15



Cazo Fire Bowl



Includes: CSA Certified 12VAC Electronic Ignition System; Bowl, Fire Plate, Burner, Gas Line, LP or NG Orifice, Mounting Bracket & Lava Rock.

SKU	IGNITION	SIZE	BASE	HEIGHT	BURNER	BTU	SUGG. GLASS
OPT-24RFO	Match Lit	24"	9"	8"	8"	65,000	40 lbs.
OPT-31RFO	Match Lit	31"	12"	10"	12"	65,000	55 lbs.
OPT-36RFO	Match Lit	36"	20"	10"	12"	65,000	95 lbs.
OPT-48RFO	Match Lit	48"	20"	17"	18"	65,000	200 lbs.
OPT-24RFOE12V	Electronic	24"	9"	8"	8"	65,000	40 lbs.
OPT-31RFOE12V	Electronic	31"	12"	10"	12"	65,000	55 lbs.
OPT-36RFOE12V	Electronic	36"	20"	10"	12"	65,000	95 lbs.
OPT-48RFOE12V	Electronic	48"	20"	17"	18"	65,000	200 lbs.



The Outdoor Plus individually handcrafts all of the products shown here. Finishes are subject to slight texture/color variations.

CAZO CONCRETE BOWLS

Cazo Fire & Water Bowl



Includes: CSA Certified 12VAC Electronic Ignition System; Bowl, Fire Plate, Burner, Gas Line, LP or NG Orifice, Copper Scupper, Mounting Bracket & Lava Rock.

SKU	IGNITION	SIZE	BASE	HEIGHT	BURNER	BTU	SUGG. GLASS	GPM
OPT-24RFWM	Match Lit	24"	9"	8"	8"	65,000	40 lbs.	12-15
OPT-31RFWM	Match Lit	31"	12"	10"	12"	65,000	55 lbs.	12-15
OPT-36RFWM	Match Lit	36"	20"	10"	12"	65,000	95 lbs.	12-15
OPT-48RFWM	Match Lit	48"	20"	17"	18"	65,000	200 lbs.	20-25
OPT-24FWE12V	Electronic	24"	9"	8"	8"	65,000	40 lbs.	12-15
OPT-31FWE12V	Electronic	31"	12"	10"	12"	65,000	55 lbs.	12-15
OPT-36FWE12V	Electronic	36"	20"	10"	12"	65,000	95 lbs.	12-15
OPT-48FWE12V	Electronic	48"	20"	17"	18"	65,000	200 lbs.	20-25



All Water Bowls Include The Easy Flow Fitting

All Water Bowls come with our easy-flow water fitting that accommodates a 1 1/2" water line



Mounted Key Valve Upgrade OPT-KVI

Installed Onto Bowl: Key Valve, Installation Bracket, & Gas Hoses

The Outdoor Plus individually handcrafts all of the products shown here. Finishes are subject to slight texture/color variations. Metallic Finishes and Rustic Finishes are available at an extra charge

When ordering, specify the concrete color by adding the color code to the end of the part number. **Example:** 27" Brown Sedona Water Bowl = OPT-27RWO-BRN

Black -BLK	Ash -ASH	Natural Gray -NGY	Gray -GRY	White Limestone -LIM	Chocolate -CHC	Chestnut -CST	Brown -BRN	Vanilla -VAN
Rustic Gray -RGR	Moss Stone -RMS	Rustic White -RWH	Coffee -RCF	Slate -MSL	Silver -MSV	Pearl -MPR	Bronze -MBR	Copper -MCP



31" Gray Cazo Fire & Water Bowl



31" Gray Cazo Fire & Water Bowl

MAYA CONCRETE BOWLS



Maya Planter Bowl

Includes: Bowl (Soil and plants not included.)

SKU	SIZE	BASE	HEIGHT	SOIL USAGE
OPT-24SP	24" x 24"	12" x 12"	10"	1 ft ³
OPT-30SP	30" x 30"	12" x 12"	10"	2 ft ³
OPT-36SP	36" x 36"	20" x 20"	10"	3 ft ³

Maya Planter & Water Bowl

Includes: Bowl, Copper Scupper (¾" Scupper).
(Soil and plants not included)

SKU	SIZE	BASE	HEIGHT	SOIL USAGE	GPM
OPT-24SPW	24" x 24"	12" x 12"	10"	1 ft ³	12-15
OPT-30SPW	30" x 30"	12" x 12"	10"	2 ft ³	12-15
OPT-36SPW	36" x 36"	20" x 20"	10"	3 ft ³	12-15



Maya Water Bowl

Includes: Bowl, Smooth Flow Water Fitting (1 ½" Connection) & Copper Scupper

SKU	SIZE	BASE	HEIGHT	GPM
OPT-24SWO	24" x 24"	12" x 12"	10"	12-15
OPT-30SWO	30" x 30"	12" x 12"	10"	12-15
OPT-36SWO	36" x 36"	20" x 20"	10"	12-15



All Water Bowls Include The Easy Flow Fitting

All Water Bowls come with our easy-flow water fitting that accommodates a 1 ½" water line



Mounted Key Valve Upgrade OPT-KVI

Installed Onto Bowl: Key Valve, Installation Bracket, & Gas Hoses

The Outdoor Plus individually handcrafts all of the products shown here. Finishes are subject to slight texture/color variations. Metallic Finishes and Rustic Finishes are available at an extra charge

When ordering, specify the concrete color by adding the color code to the end of the part number. **Example:** 24" Black Maya Water Bowl = OPT-24SWO-BLK

Black -BLK	Ash -ASH	Natural Gray -NGY	Gray -GRY	White Limestone -LIM	Chocolate -CHC	Chestnut -CST	Brown -BRN	Vanilla -VAN
Rustic Gray -RGR	Moss Stone -RMS	Rustic White -RWH	Coffee -RCF	Slate -MSL	Silver -MSV	Pearl -MPR	Bronze -MBR	Copper -MCP



MAYA CONCRETE BOWLS

Maya Fire Bowl



Includes: CSA Certified 12VAC Electronic Ignition System; Bowl, Fire Plate, Burner, Gas Line, LP or NG Orifice, Mounting Bracket & Lava Rock.





SKU	IGNITION	SIZE	BASE	HEIGHT	BURNER	BTU	SUGG. GLASS
OPT-24SFO	Match Lit	24" x 24"	12" x 12"	10"	10"	65,000	40 lbs.
OPT-30SFO	Match Lit	30" x 30"	12" x 12"	10"	12"	65,000	55 lbs.
OPT-36SFO	Match Lit	36" x 36"	20" x 20"	10"	12"	65,000	95 lbs.
 OPT-24SFOE12V	Electronic	24" x 24"	12" x 12"	10"	10"	65,000	40 lbs.
 OPT-30SFOE12V	Electronic	30" x 30"	12" x 12"	10"	12"	65,000	55 lbs.
 OPT-36SFOE12V	Electronic	36" x 36"	20" x 20"	10"	12"	65,000	95 lbs.

Maya Fire & Water Bowl



Includes: CSA Certified 12VAC Electronic Ignition System; Bowl, Fire Plate, Burner, Gas Line, LP or NG Orifice, Copper Scupper, Mounting Bracket & Lava Rock.



SKU	IGNITION	SIZE	BASE	HEIGHT	BURNER	BTU	SUGG. GLASS	GPM
OPT-24SFWM	Match Lit	24" x 24"	12" x 12"	10"	10"	65,000	40 lbs.	12-15
OPT-30SFWM	Match Lit	30" x 30"	12" x 12"	10"	12"	65,000	55 lbs.	12-15
OPT-36SFWM	Match Lit	36" x 36"	20" x 20"	10"	12"	65,000	95 lbs.	12-15
 OPT-24SFWE12V	Electronic	24" x 24"	12" x 12"	10"	10"	65,000	40 lbs.	12-15
 OPT-30SFWE12V	Electronic	30" x 30"	12" x 12"	10"	12"	65,000	55 lbs.	12-15
 OPT-36SFWE12V	Electronic	36" x 36"	20" x 20"	10"	12"	65,000	95 lbs.	12-15

The Outdoor Plus individually handcrafts all of the products shown here. Finishes are subject to slight texture/color variations.

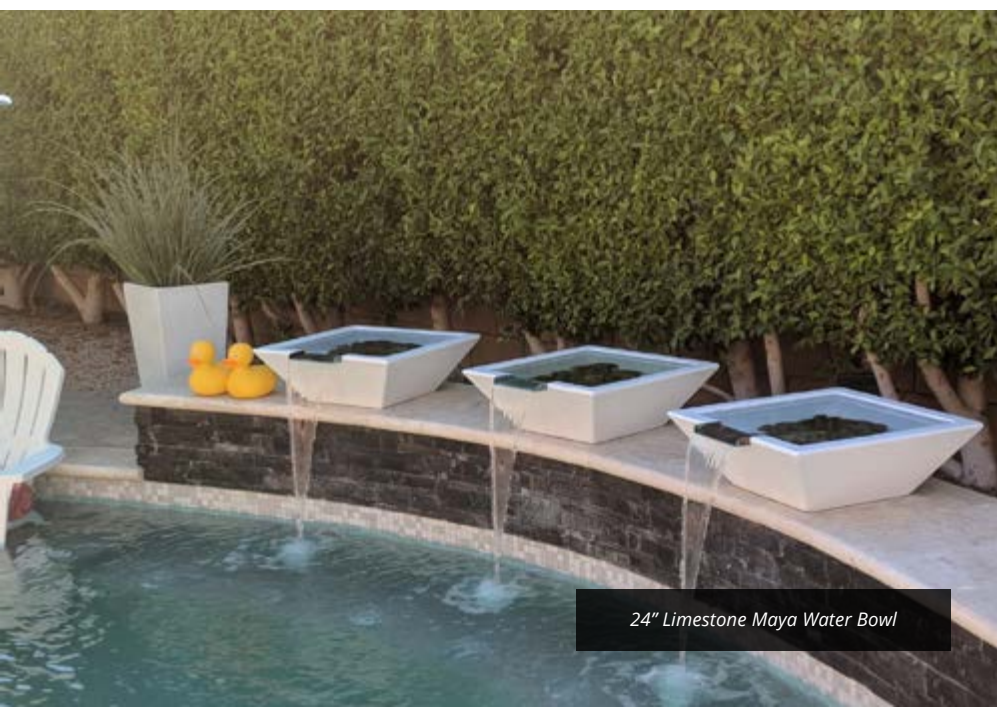

24" Limestone Maya Water Bowl



30" Black Maya Fire Bowl

AVALON CONCRETE BOWLS



Avalon Planter Bowl

Includes: Bowl (Soil and plants not included.)

SKU	SIZE	BASE	HEIGHT	SOIL USAGE
OPT-AVLPO24	24" x 24"	12" x 12"	10"	1 ft ³
OPT-AVLPO30	30" x 30"	12" x 12"	10"	2 ft ³
OPT-AVLPO36	36" x 36"	20" x 20"	10"	3 ft ³

Avalon Planter & Water Bowl

Includes: Bowl, Copper Scupper (¾" Scupper). (Soil and plants not included)

SKU	SIZE	BASE	HEIGHT	SOIL USAGE	GPM
OPT-AVLPW24	24" x 24"	12" x 12"	10"	1 ft ³	12-15
OPT-AVLPW30	30" x 30"	12" x 12"	10"	2 ft ³	12-15
OPT-AVLPW36	36" x 36"	20" x 20"	10"	3 ft ³	12-15



Avalon Water Bowl

Includes: Bowl, Smooth Flow Water Fitting (1 ½" Connection) & Copper Scupper



SKU	SIZE	BASE	HEIGHT	GPM
OPT-AVLWO24	24" x 24"	12" x 12"	10"	12-15
OPT-AVLWO30	30" x 30"	12" x 12"	10"	12-15
OPT-AVLWO36	36" x 36"	20" x 20"	10"	12-15



All Water Bowls Include The Easy Flow Fitting
All Water Bowls come with our easy-flow water fitting that accommodates a 1 ½" water line



Mounted Key Valve Upgrade OPT-KVI
Installed Onto Bowl: Key Valve, Installation Bracket, & Gas Hoses

The Outdoor Plus individually handcrafts all of the products shown here. Finishes are subject to slight texture/color variations. Metallic Finishes and Rustic Finishes are available at an extra charge

When ordering, specify the concrete color by adding the color code to the end of the part number. **Example:** 24" Black Avalon Water Bowl = OPT-AVLWO24-BLK

Black -BLK	Ash -ASH	Natural Gray -NGY	Gray -GRY	White Limestone -LIM	Chocolate -CHC	Chestnut -CST	Brown -BRN	Vanilla -VAN
Rustic Gray -RGR	Moss Stone -RMS	Rustic White -RWH	Coffee -RCF	Slate -MSL	Silver -MSV	Pearl -MPR	Bronze -MBR	Copper -MCP

AVALON CONCRETE BOWLS



Avalon Fire Bowl



Includes: CSA Certified 12VAC Electronic Ignition System; Bowl, Fire Plate, Burner, Gas Line, LP or NG Orifice, Mounting Bracket & Lava Rock.

SKU	IGNITION	SIZE	BASE	HEIGHT	BURNER	BTU	SUGG. GLASS
OPT-AVLFO24	Match Lit	24" x 24"	12" x 12"	10"	10"	65,000	40 lbs.
OPT-AVLFO30	Match Lit	30" x 30"	12" x 12"	10"	12"	65,000	55 lbs.
OPT-AVLFO36	Match Lit	36" x 36"	20" x 20"	10"	12"	65,000	95 lbs.
OPT-AVLFO24E12V	Electronic	24" x 24"	12" x 12"	10"	10"	65,000	40 lbs.
OPT-AVLFO30E12V	Electronic	30" x 30"	12" x 12"	10"	12"	65,000	55 lbs.
OPT-AVLFO36E12V	Electronic	36" x 36"	20" x 20"	10"	12"	65,000	95 lbs.

Avalon Fire & Water Bowl



Includes: CSA Certified 12VAC Electronic Ignition System; Bowl, Fire Plate, Burner, Gas Line, LP or NG Orifice, Copper Scupper, Mounting Bracket & Lava Rock.

SKU	IGNITION	SIZE	BASE	HEIGHT	BURNER	BTU	SUGG. GLASS	GPM
OPT-AVLFW24	Match Lit	24" x 24"	12" x 12"	10"	10"	65,000	40 lbs.	12-15
OPT-AVLFW30	Match Lit	30" x 30"	12" x 12"	10"	12"	65,000	55 lbs.	12-15
OPT-AVLFW36	Match Lit	36" x 36"	20" x 20"	10"	12"	65,000	95 lbs.	12-15
OPT-AVLFW24E12V	Electronic	24" x 24"	12" x 12"	10"	10"	65,000	40 lbs.	12-15
OPT-AVLFW30E12V	Electronic	30" x 30"	12" x 12"	10"	12"	65,000	55 lbs.	12-15
OPT-AVLFW36E12V	Electronic	36" x 36"	20" x 20"	10"	12"	65,000	95 lbs.	12-15



CAZO COPPER BOWLS

Cazo 4-Way Fire & Water Bowl



Includes: CSA Certified 12VAC Electronic Ignition System; Bowl, Fire Plate, Burner, Mounting Bracket & Lava Rock. 1 1/2" Water Inlet



SKU	IGNITION	SIZE	BASE	HEIGHT	BURNER	BTU	SUGG. GLASS	GPM
OPT-4W30	Match Lit	30"	16"	12"	12"	65,000	40 lbs.	25-30
OPT-4W36	Match Lit	36"	20"	12"	12"	65,000	55 lbs.	25-30
OPT-4W30E12V	Electronic	30"	16"	12"	12"	65,000	40 lbs.	25-30
OPT-4W36E12V	Electronic	36"	20"	12"	12"	65,000	55 lbs.	25-30

Cazo 360° Fire & Water Bowl



Includes: Certified Electronic Ignition System; Bowl, Fire Plate, Burner, Gas Line, LP or NG Orifice, Mounting Bracket & Lava Rock. 1 1/2" Water Inlet

SKU	IGNITION	SIZE	BASE	HEIGHT	BURNER	BTU	SUGG. GLASS	GPM
OPT-30FW360	Match Lit	30"	16"	12"	8"	65,000	25 lbs.	25-30
OPT-36FW360	Match Lit	36"	20"	12"	8"	65,000	35 lbs.	25-30
OPT-30FW360E12V	Electronic	30"	16"	12"	8"	65,000	25 lbs.	25-30
OPT-36FW360E12V	Electronic	36"	20"	12"	8"	65,000	35 lbs.	25-30



REMI COPPER BOWL

Cazo Planter Bowl

Includes: Bowl (Soil and plants not included.)



SKU	SIZE	BASE	HEIGHT	SOIL USAGE
OPT-R24CPO	24"	10"	10"	1.25 ft ³
OPT-R30CPO	30"	16"	12"	3 ft ³
OPT-R36CPO	36"	20"	12"	4.5 ft ³

Cazo Planter Bowl with Water Spillway

Includes: Bowl, Copper Scupper (¾" Scupper).
(Soil and plants not included)

SKU	SIZE	BASE	HEIGHT	GPM	WATER INLET	SOIL USAGE
OPT-R24CPW	24"	10"	10"	12-15	¾"	1.25 ft ³
OPT-R30CPW	30"	16"	12"	12-15	¾"	3 ft ³
OPT-R36CPW	36"	20"	12"	12-15	¾"	4.5 ft ³

Cazo Water Bowl

Includes: Bowl, (1 ½" Water Connection)

SKU	SIZE	BASE	HEIGHT	GPM
OPT-R24CPWO	24"	10"	10"	12-15
OPT-R30CPWO	30"	16"	12"	12-15
OPT-R36CPWO	36"	20"	12"	12-15



Cazo Fire Bowl



Includes: CSA CertifEd 12VAC Electronic Ignition System; Bowl, Fire Plate, Burner, Gas Line, LP or NG Orifice, Mounting Bracket & Lava Rock.



SKU	IGNITION	SIZE	BASE	HEIGHT	BURNER	BTU	SUGG. GLASS
OPT-101-24NWF	Match Lit	24"	10"	10"	8"	65,000	25 lbs
OPT-102-30NWF	Match Lit	30"	16"	12"	12"	65,000	50 lbs
OPT-102-36NWF	Match Lit	36"	20"	12"	12"	65,000	50 lbs
OPT-101-24NWF12V	Electronic	24"	10"	10"	8"	65,000	25 lbs
OPT-102-30NWF12V	Electronic	30"	16"	12"	12"	65,000	50 lbs
OPT-102-36NWF12V	Electronic	36"	20"	12"	12"	65,000	50 lbs

Cazo Fire & Water Bowl



Includes: CSA CertifEd 12VAC Electronic Ignition System; Bowl, Fire Plate, Burner, Gas Line, LP or NG Orifice, Mounting Bracket & Lava Rock. ¾" Water Inlet

SKU	IGNITION	SIZE	BASE	HEIGHT	BURNER	BTU	SUGG. GLASS	GPM
OPT-101-24NWCB	Match Lit	24"	10"	10"	8"	65,000	25 lbs	12-15
OPT-102-30NWCB	Match Lit	30"	16"	12"	12"	65,000	50 lbs	12-15
OPT-102-36NWCB	Match Lit	36"	20"	12"	12"	65,000	50 lbs	12-15
OPT-101-24NWCBE12V	Electronic	24"	10"	10"	8"	65,000	25 lbs	12-15
OPT-102-30NWCBE12V	Electronic	30"	16"	12"	12"	65,000	50 lbs	12-15
OPT-102-36NWCBE12V	Electronic	36"	20"	12"	12"	65,000	50 lbs	12-15



The Outdoor Plus individually handcrafts all of the products shown here. Finishes are subject to slight texture/color variations.

REMI COPPER BOWLS

Remi Planter

Includes: Bowl (Soil and plants not included.)

SKU	SIZE	BASE	HEIGHT	SOIL USAGE
OPT-31RCPO	31"	13"	11.5"	2.5 ft ³



Remi Planter with Water Spillway

Includes: Bowl, Copper Scupper (¾" Scupper).

(Soil and plants not included)

SKU	SIZE	BASE	HEIGHT	GPM	INLET	SOIL USAGE
OPT-31RCPW	31"	13"	11.5"	12-15	¾"	2.5 ft ³



Remi Water Bowl

Includes: Smooth Flow Water Fitting (1 ½" Connection)

SKU	SIZE	BASE	HEIGHT	GPM
OPT-31RCWO	31"	13"	11.5"	12-15

Remi Fire Bowl



Includes: CSA CertifEd 12VAC Electronic Ignition System; Bowl, Fire Plate, Burner, Gas Line, LP or NG Orifice, Mounting Bracket & Lava Rock.

SKU	IGNITION	SIZE	BASE	HEIGHT	BURNER	BTU	SUGG. GLASS
OPT-31RCFOM	Match Lit	31"	13"	11.5"	12"	65,000	75 lbs
OPT-31RCFOE12V	Electronic	31"	13"	11.5"	12"	65,000	75 lbs.



Remi Fire & Water Bowl



Includes: CSA CertifEd 12VAC Electronic Ignition System; Bowl, Fire Plate, Burner, Gas Line, LP or NG Orifice, Mounting Bracket & Lava Rock. ¾" Water Inlet

SKU	IGNITION	SIZE	BASE	HEIGHT	BURNER	BTU	SUGG. GLASS	GPM
OPT-31RCFWM	Match Lit	31"	13"	11.5"	12"	65,000	75 lbs	12-15
OPT-31RCFWE12V	Electronic	31"	13"	11.5"	12"	65,000	75 lbs.	12-15



All Water Bowls Include The Easy Flow Fitting

All Water Bowls come with our easy-flow water fitting that accommodates a 1 ½" water line



Mounted Key Valve Upgrade OPT-KVI

Installed Onto Bowl: Key Valve, Installation Bracket, & Gas Hoses

The Outdoor Plus individually handcrafts all of the products shown here. Finishes are subject to slight texture/color variations.

MAYA COPPER BOWLS

Custom Sizes Available



Maya Planter Bowl

Includes: Bowl (Soil and plants not included.)

SKU	SIZE	BASE	HEIGHT	SOIL USAGE
OPT-24SCPO	24" x 24"	12" x 12"	10"	3 ft ³
OPT-30SCPO	30" x 30"	15" x 15"	10"	3 ft ³
OPT-36SCPO	36" x 36"	18" x 18"	12"	5.25 ft ³



Maya Planter Bowl with Water Spillway

Includes: Bowl, Copper Scupper (¾" Scupper).
(Soil and plants not included)

SKU	SIZE	BASE	HEIGHT	GPM	WATER INLET	SOIL USAGE
OPT-24SCPW	24" x 24"	12" x 12"	10"	12-15	¾"	3 ft ³
OPT-30SCPW	30" x 30"	15" x 15"	10"	12-15	¾"	3 ft ³
OPT-36SCPW	36" x 36"	18" x 18"	12"	12-15	¾"	5.25 ft ³

Maya Water Bowl

Includes: Bowl, (1 ½" Water Connection)

SKU	SIZE	BASE	HEIGHT	GPM
OPT-24SCW	24" x 24"	12" x 12"	10"	12-15
OPT-30SCW	30" x 30"	15" x 15"	10"	15-20
OPT-36SCW	36" x 36"	18" x 18"	12"	20-25



Maya Water Bowl - Wide Spill

Includes: Smooth Flow Water Fitting (¾" Water Connection)

SKU	SIZE	BASE	HEIGHT	GPM
OPT-24SCXW	24" x 24"	12" x 12"	10"	15-20
OPT-30SCXW	30" x 30"	15" x 15"	10"	15-20
OPT-36SCXW	36" x 36"	18" x 18"	12"	15-20



All Water Bowls Include The Easy Flow Fitting

All Water Bowls come with our easy-flow water fitting that accommodates a 1 ½" water line



Mounted Key Valve Upgrade OPT-KVI

Installed Onto Bowl: Key Valve, Installation Bracket, & Gas Hoses

The Outdoor Plus individually handcrafts all of the products shown here. Finishes are subject to slight texture/color variations.

MAYA COPPER BOWLS

Maya Fire Bowl



Includes: CSA Certified 12VAC Electronic Ignition System; Bowl, Fire Plate, Burner, Gas Line, LP or NG Orifice, Mounting Bracket & Lava Rock.



SKU	IGNITION	SIZE	BASE	HEIGHT	BURNER	BTU	SUGG. GLASS
OPT-103-SQ24	Match Lit	24" x 24"	12" x 12"	10"	8"	65,000	45 lbs.
OPT-103-SQ30	Match Lit	30" x 30"	15" x 15"	10"	12"	65,000	60 lbs.
OPT-103-SQ36	Match Lit	36" x 36"	18" x 18"	12"	12"	65,000	95 lbs.
OPT-103-SQ24E12V	Electronic	24" x 24"	12" x 12"	10"	8"	65,000	45 lbs.
OPT-103-SQ30E12V	Electronic	30" x 30"	15" x 15"	10"	12"	65,000	60 lbs.
OPT-103-SQ36E12V	Electronic	36" x 36"	18" x 18"	12"	12"	65,000	95 lbs.

Maya Fire & Water Bowl



Includes: CSA Certified 12VAC Electronic Ignition System; Bowl, Fire Plate, Burner, Gas Line, LP or NG Orifice, Mounting Bracket & Lava Rock. 3/4" Water Inlet.



SKU	IGNITION	SIZE	BASE	HEIGHT	BURNER	BTU	SUGG. GLASS	GPM
OPT-24SCFW	Match Lit	24" x 24"	12" x 12"	10"	8"	65,000	45 lbs.	12-15
OPT-30SCFW	Match Lit	30" x 30"	15" x 15"	10"	12"	65,000	60 lbs.	12-15
OPT-36SCFW	Match Lit	36" x 36"	18" x 18"	12"	12"	65,000	95 lbs.	12-15
OPT-24SCFWE12V	Electronic	24" x 24"	12" x 12"	10"	8"	65,000	45 lbs.	12-15
OPT-30SCFWE12V	Electronic	30" x 30"	15" x 15"	10"	12"	65,000	60 lbs.	12-15
OPT-36SCFWE12V	Electronic	36" x 36"	18" x 18"	12"	12"	65,000	95 lbs.	12-15

Maya Fire & Water Bowl - Gravity Spill



Includes: CSA Certified 12VAC Electronic Ignition System; Bowl, Fire Plate, Burner, Gas Line, LP or NG Orifice, Mounting Bracket & Lava Rock. 1 1/2" Water Inlet.



SKU	IGNITION	SIZE	BASE	HEIGHT	BURNER	BTU	SUGG. GLASS	GPM
OPT-SQ24FANDW	Match Lit	24" x 24"	12" x 12"	10"	8"	65,000	30 lbs.	12-15
OPT-SQ30FANDW	Match Lit	30" x 30"	15" x 15"	10"	12"	65,000	45 lbs.	12-15
OPT-SQ36FANDW	Match Lit	36" x 36"	18" x 18"	12"	12"	65,000	60 lbs.	12-15
OPT-SQ24FANDWE12V	Electronic	24" x 24"	12" x 12"	10"	8"	65,000	30 lbs.	12-15
OPT-SQ30FANDWE12V	Electronic	30" x 30"	15" x 15"	10"	12"	65,000	45 lbs.	12-15
OPT-SQ36FANDWE12V	Electronic	36" x 36"	18" x 18"	12"	12"	65,000	60 lbs.	12-15

Maya 4-Way Fire & Water Bowl



Includes: CSA Certified 12VAC Electronic Ignition System; Bowl, Fire Plate, Burner, Gas Line, LP or NG Orifice, Mounting Bracket & Lava Rock. 1 1/2" Water Inlet.



SKU	IGNITION	SIZE	BASE	HEIGHT	BURNER	BTU	SUGG. GLASS	GPM
OPT-30FW4WM	Match Lit	30" x 30"	15" x 15"	10"	12"	65,000	45 lbs.	12-15
OPT-36FW4WM	Match Lit	36" x 36"	18" x 18"	12"	12"	65,000	60 lbs.	12-15
OPT-30FW4WE12V	Electronic	30" x 30"	15" x 15"	10"	12"	65,000	45 lbs.	12-15
OPT-36FW4WE12V	Electronic	36" x 36"	18" x 18"	12"	12"	65,000	60 lbs.	12-15

The Outdoor Plus individually handcrafts all of the products shown here. Finishes are subject to slight texture/color variations.

COPPER BOWLS



Custom Sizes Available



Nile Fire & Water Bowl



Includes: CSA Certified 12VAC Electronic Ignition System; Bowl, Fire Plate, Burner, Gas Line, LP or NG Orifice, Mounting Bracket & Lava Rock. 3/4" Water Inlet Connection

SKU	IGNITION	LENGTH	WIDTH	HEIGHT	BASE	BURNER	BTU	GPM
OPT-24NLCPF	Match Lit	30"	24"	14"	12" x 10"	12"	65,000	12-15
OPT-30NLCPF	Match Lit	40"	30"	14"	16" x 12"	15"	65,000	12-15
OPT-36NLCPF	Match Lit	48"	36"	14"	18" x 15"	18"	65,000	12-15
 OPT-24NLCPFE12V	Electronic	30"	24"	14"	12" x 10"	12"	65,000	12-15
 OPT-30NLCPFE12V	Electronic	40"	30"	14"	16" x 12"	15"	65,000	12-15
 OPT-36NLCPFE12V	Electronic	48"	36"	14"	18" x 15"	18"	65,000	12-15

Avalon Water Only Bowl - Stainless Steel

Includes: Bowl, (1 1/2" Water Connection)



SKU	SIZE	BASE	HEIGHT	GPM
OPT-24AVSSWO	24" x 24"	12" x 12"	8"	12-15
OPT-30AVSSWO	30" x 30"	15" x 15"	10"	12-15
OPT-36AVSSWO	36" x 36"	18" x 18"	12"	12-15

Avalon Water Only Bowl

Includes: Bowl, (1 1/2" Water Connection)



SKU	SIZE	BASE	HEIGHT	GPM
OPT-24AVCPWO	24" x 24"	12" x 12"	8"	12-15
OPT-30AVCPWO	30" x 30"	15" x 15"	10"	12-15
OPT-36AVCPWO	36" x 36"	18" x 18"	12"	12-15

The Outdoor Plus individually handcrafts all of the products shown here. Finishes are subject to slight texture/color variations.

COPPER BOWLS



Avalon Fire Bowl

Includes: CSA Certified 12VAC Electronic Ignition System; Bowl, Fire Plate, Burner, Gas Line, LP or NG Orifice, Mounting Bracket & Lava Rock. 3/4" Water Inlet

SKU (COPPER)	SKU (STAINLESS STEEL)	IGNITION	SIZE	BASE	HEIGHT	BURNER	BTU	SUGG. GLASS
OPT-24AVCPF	OPT-24AVSSF	Match Lit	24" x 24"	12" x 12"	10"	8"	65,000	45 lbs.
OPT-30AVCPF	OPT-30AVSSF	Match Lit	30" x 30"	15" x 15"	10"	12"	65,000	60 lbs.
OPT-36AVCPF	OPT-36AVSSF	Match Lit	36" x 36"	18" x 18"	12"	12"	65,000	95 lbs.
OPT-24AVCPF12V	OPT-24AVSSFE12V	Electronic	24" x 24"	12" x 12"	10"	8"	65,000	45 lbs.
OPT-30AVCPF12V	OPT-30AVSSFE12V	Electronic	30" x 30"	15" x 15"	10"	12"	65,000	60 lbs.
OPT-36AVCPF12V	OPT-36AVSSFE12V	Electronic	36" x 36"	18" x 18"	12"	12"	65,000	95 lbs.

NOTE: Polished Lava Rock Shown, Additional Upgrade



Avalon Fire & Water Bowl

Includes: CSA Certified 12VAC Electronic Ignition System; Bowl, Fire Plate, Burner, Gas Line, LP or NG Orifice, Mounting Bracket & Lava Rock. 3/4" Water Inlet

SKU (COPPER)	SKU (STAINLESS STEEL)	IGNITION	SIZE	BASE	HEIGHT	BURNER	BTU	SUGG. GLASS	GPM
OPT-24AVCPF12V	OPT-24AVSSFE12V	Electronic	24" x 24"	12" x 12"	10"	8"	65,000	45 lbs.	12-15
OPT-30AVCPF12V	OPT-30AVSSFE12V	Electronic	30" x 30"	15" x 15"	10"	12"	65,000	60 lbs.	12-15
OPT-36AVCPF12V	OPT-36AVSSFE12V	Electronic	36" x 36"	18" x 18"	12"	12"	65,000	95 lbs.	12-15

The Outdoor Plus individually handcrafts all of the products shown here. Finishes are subject to slight texture/color variations.

MAYA BOWLS - POWDER COAT FINISH

Custom Sizes Available

Maya Planter Bowl

Includes: Bowl (Soil and plants not included.)



SKU	SIZE	BASE	HEIGHT
OPT-24SQPCPO	24" x 24"	12" x 12"	10"
OPT-30SQPCPO	30" x 30"	15" x 15"	10"
OPT-36SQPCPO	36" x 36"	18" x 18"	12"

Maya Planter Bowl with Water Spillway

Includes: Bowl, (¾" Scupper Inlet)
(Soil and plants not included)

SKU	SIZE	BASE	HEIGHT	GPM	WATER INLET
OPT-24SQPCPW	24" x 24"	12" x 12"	10"	12-15	¾"
OPT-30SQPCPW	30" x 30"	15" x 15"	10"	12-15	¾"
OPT-36SQPCPW	36" x 36"	18" x 18"	12"	12-15	¾"

Maya Water Bowl

Includes: Smooth Flow Water Fitting (1 ½" Connection)



SKU	SIZE	BASE	HEIGHT	GPM
OPT-24SQPCWO	24" x 24"	12" x 12"	10"	12-15
OPT-30SQPCWO	30" x 30"	15" x 15"	10"	15-20
OPT-36SQPCWO	36" x 36"	18" x 18"	12"	20-25



Maya Fire Bowl



Includes: CSA CertifEd 12VAC Electronic Ignition System; Bowl, Fire Plate, Burner, Gas Line, LP or NG Orifice, Mounting Bracket & Lava Rock.



SKU	IGNITION	SIZE	BASE	HEIGHT	BURNER	BTU	SUGG. GLASS
OPT-24SQPCFO	Match Lit	24" x 24"	12" x 12"	10"	8"	65,000	50 lbs.
OPT-30SQPCFO	Match Lit	30" x 30"	15" x 15"	10"	12"	65,000	75 lbs.
OPT-36SQPCFO	Match Lit	36" x 36"	18" x 18"	12"	12"	65,000	100 lbs.
 OPT-24SQPCFOE12V	Electronic	24" x 24"	12" x 12"	10"	8"	65,000	50 lbs.
 OPT-30SQPCFOE12V	Electronic	30" x 30"	15" x 15"	10"	12"	65,000	75 lbs.
 OPT-36SQPCFOE12V	Electronic	36" x 36"	18" x 18"	12"	12"	65,000	100 lbs.

Maya Fire & Water Bowl

Includes: CSA CertifEd 12VAC Electronic Ignition System; Bowl, Fire Plate, Burner, Gas Line, LP or NG Orifice, Mounting Bracket & Lava Rock. ¾" Water Inlet.

SKU	IGNITION	SIZE	BASE	HEIGHT	BURNER	BTU	SUGG. GLASS	GPM
OPT-24SQPCFW	Match Lit	24" x 24"	12" x 12"	10"	8"	65,000	50 lbs.	20
OPT-30SQPCFW	Match Lit	30" x 30"	15" x 15"	10"	12"	65,000	75 lbs.	25
OPT-36SQPCFW	Match Lit	36" x 36"	18" x 18"	12"	12"	65,000	100 lbs.	30
 OPT-24SQPCFWE12V	Electronic	24" x 24"	12" x 12"	10"	8"	65,000	50 lbs.	20
 OPT-30SQPCFWE12V	Electronic	30" x 30"	15" x 15"	10"	12"	65,000	75 lbs.	25
 OPT-36SQPCFWE12V	Electronic	36" x 36"	18" x 18"	12"	12"	65,000	100 lbs.	30



The Outdoor Plus individually handcrafts all of the products shown here. Finishes are subject to slight texture/color variations.

CAZO POWDER COAT BOWLS

Cazo Planter Bowl

Includes: Bowl (Soil and plants not included.)



SKU	SIZE	BASE	HEIGHT
OPT-R24PCPO	24"	10"	10"
OPT-R30PCPO	30"	16"	12"
OPT-R36PCPO	36"	20"	12"

Cazo Planter Bowl with Water Spillway

Includes: Bowl, (3/4" Scupper Inlet) (Soil and plants not included)

SKU	SIZE	BASE	HEIGHT	GPM	WATER INLET
OPT-R24PCPW	24"	10"	10"	15-20	3/4"
OPT-R30PCPW	30"	16"	12"	15-20	3/4"
OPT-R36PCPW	36"	20"	12"	15-20	3/4"

Cazo Water Bowl

Includes: Smooth Flow Water Fitting (1 1/2" Connection)



SKU	SIZE	BASE	HEIGHT	GPM
OPT-R24PCWO	24"	10"	10"	20
OPT-R30PCWO	30"	16"	12"	25
OPT-R36PCWO	36"	20"	12"	30



Cazo Fire Bowl



Includes: CSA CertifEd 12VAC Electronic Ignition System; Bowl, Fire Plate, Burner, Gas Line, LP or NG Orifice, Mounting Bracket & Lava Rock.



SKU	IGNITION	SIZE	BASE	HEIGHT	BURNER	BTU	SUGG. GLASS
OPT-R24PCFO	Match Lit	24"	10"	10"	8"	65,000	25 lbs
OPT-R30PCFO	Match Lit	30"	16"	12"	12"	65,000	50 lbs
OPT-R36PCFO	Match Lit	36"	20"	12"	12"	65,000	50 lbs
 OPT-R24PCFOE12V	Electronic	24"	10"	10"	8"	65,000	25 lbs
 OPT-R30PCFOE12V	Electronic	30"	16"	12"	12"	65,000	50 lbs
 OPT-R36PCFOE12V	Electronic	36"	20"	12"	12"	65,000	50 lbs

Cazo Fire & Water Bowl

Includes: CSA CertifEd 12VAC Electronic Ignition System; Bowl, Fire Plate, Burner, Gas Line, LP or NG Orifice, Mounting Bracket & Lava Rock. 3/4" Water Inlet

SKU	IGNITION	SIZE	BASE	HEIGHT	BURNER	BTU	SUGG. GLASS	GPM
OPT-R24PCFW	Match Lit	24"	10"	10"	8"	65,000	25 lbs	15-20
OPT-R30PCFW	Match Lit	30"	16"	12"	12"	65,000	50 lbs	15-20
OPT-R36PCFW	Match Lit	36"	20"	12"	12"	65,000	50 lbs	15-20
 OPT-R24PCFWE12V	Electronic	24"	10"	10"	8"	65,000	25 lbs	15-20
 OPT-R30PCFWE12V	Electronic	30"	16"	12"	12"	65,000	50 lbs	15-20
 OPT-R36PCFWE12V	Electronic	36"	20"	12"	12"	65,000	50 lbs	15-20



Powder Coat Color Options

When ordering, specify the powder coat color by adding the color code to the end of the part number. (see swatches to the left)
Example: Gray Cazo & Fire Bowl = OPT-R24PCFW-GRY

ORNAMENTS

Custom Sizes Available



Lotus Flower Blossom

OPT-LF

Diameter: 16"

Height: 8"

BTU Output: 40,000

Inlet: 1/2"

Note - Replaces the pre-existing burner



Burning Bush

OPT-BB

Diameter: 16"

Height: 18"

BTU Output: 100,000

Inlet: 1/2"

Note - Replaces the pre-existing burner



Fire Globe Burner

OPT-FG12

Diameter: 12"

Height: 12"

BTU Output: 100,000

Inlet: 1/2"

Note - Replaces the pre-existing burner



Steel Balls

OPT-SS7

Diameter: 4"

Quantity: 7 Steel Balls

Note - Sits on top of pre-existing burner



Steel Logs

OPT-SL

Diameter: 18"

Height: 20"

Note - Sits on top of pre-existing burner



Desert Sticks

OPT-DS

Diameter: 18"

Height: 20"

Note - Sits on top of pre-existing burner



Mounted Key Valve Upgrade

OPT-KVI

- » Installed Onto The Bowl: Key Valve & Gas Hoses
- » Key Valves on bowls allows for individual flame adjustment. Your bowl(s) will ship with a key valve and gas hoses pre-installed.
- » For multiple bowls, order the matching quantity.



Concrete Pedestal

OPT-GFRCSTAND

Width: 16"

Length: 16"

Height: 21"

14" x 16" Stainless Access Door

Bowl Not Included

ORNAMENTS

FOR MORE INFORMATION ABOUT CUSTOM UNITS, VISIT PAGE 112 OR SEND AN INQUIRY ON OUR WEBSITE AT THEOUTDOORPLUS.COM/CUSTOM



SCUPPERS

Custom Sizes Available

The Outdoor Plus individually handcrafts all scuppers from high grade copper. Scuppers are finished with a dark patina. All scuppers include a 1 1/2" female water inlet & a ground terminal connection on the backside.



Radius Scupper

SKU	W	H	L
OPT-RSE8	8"	4"	8"
OPT-RSE12	12"	4"	8"
OPT-RSE24	24"	4"	8"
OPT-RSE36	36"	4"	8"
OPT-RSE48	48"	4"	8"



Arch Flow Scupper

SKU	W	H	L
OPT-ARF8	8"	5"	8"
OPT-ARF12	12"	5"	8"
OPT-ARF24	24"	5"	8"
OPT-ARF36	36"	5"	8"
OPT-ARF48	48"	5"	8"



Smooth Flow Radius Scupper

SKU	W	H	L
OPT-SFR8	8"	4"	7"
OPT-SFR12	12"	4"	7"
OPT-SFR24	24"	4"	7"
OPT-SFR36	36"	4"	7"
OPT-SFR48	48"	4"	7"

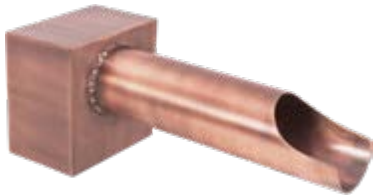

Cannon Scupper

SKU	W	H	L
OPT-CS2	2"	6"	12"
OPT-CS3	3"	6"	12"



V-Shaped Scupper

SKU	W	H	L
OPT-WS6	6"	5"	12"
OPT-WS8	8"	5"	12"
OPT-WS10	10"	5"	12"
OPT-WS12	12"	5"	12"



Straight Spillway

SKU	W	H	L
OPT-SS6	6"	2"	8"
OPT-SS8	8"	2"	8"
OPT-SS10	10"	2"	8"
OPT-SS12	12"	2"	8"



Smooth Flow Scupper

SKU	W	H	L
OPT-SFS8	8"	4"	8"
OPT-SFS12	12"	4"	8"
OPT-SFS24	24"	4"	8"
OPT-SFS36	36"	4"	8"
OPT-SFS48	48"	4"	8"



Box Scupper

SKU	W	H	L
OPT-BX6	6"	6"	8"
OPT-BX8	8"	8"	8"
OPT-BX10	10"	10"	8"
OPT-BX12	12"	12"	8"



U-Shaped Scupper

SKU	W	H	L
OPT-USS6	6"	6"	10"
OPT-USS8	8"	6"	10"
OPT-USS10	10"	6"	10"
OPT-USS12	12"	6"	10"

The Outdoor Plus individually handcrafts all of the products shown here. Finishes are subject to slight texture/color variations.

SCUPPERS

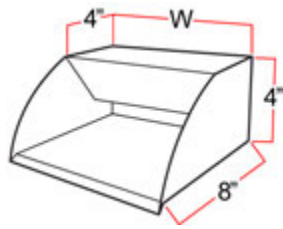

Radius Scupper

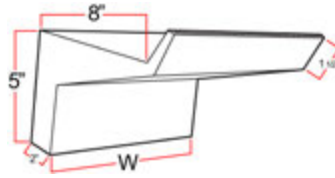

Arch Flow Scupper

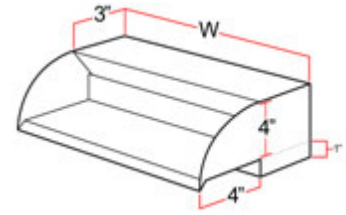

Smooth Flow Radius Scupper

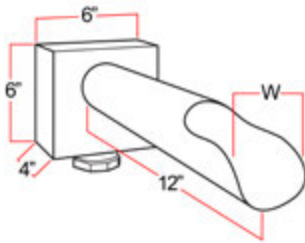

Cannon Scupper

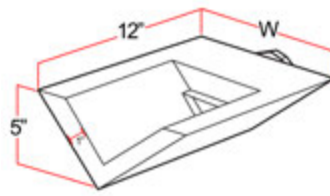

V-Shaped Scupper

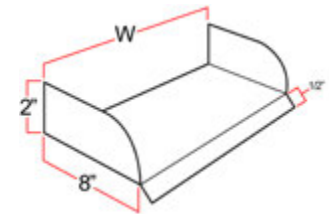

Straight Spillway

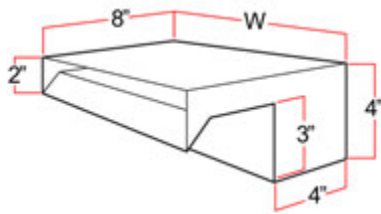

Smooth Flow Scupper

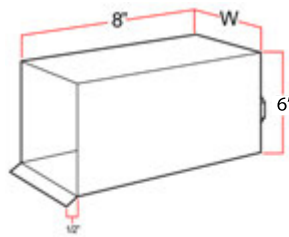

Box Scupper

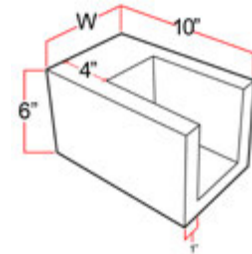

U-Shaped Scupper

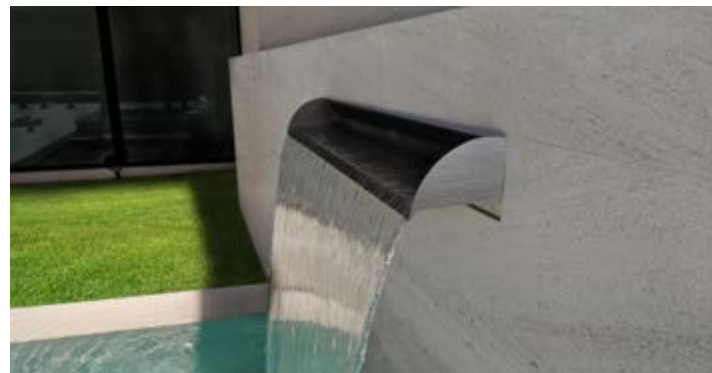

SELF CONTAINED UNITS

Custom Sizes Available



Our Self Contained Units come equipped with all necessary components for plug and play application. All units are ready to be finished with your choice of exterior such as stones, bricks, pavers, veneer, coping, etc. They may also be enjoyed as is. Each unit is constructed from marine grade stainless steel and finished with powder coat for double the protection

Custom Sizes Available

Olympian - 4 Way Spill

OPT-OLR60 Match Lit
OPT-OLR60EKIT Electronic Ignition

- » Overall Diameter: 60"
- » Overall Height: 36"

WATER TANK

- » Diameter: 60"
- » Height: 22"
- » Basin Depth: 12"
- » Tank Includes: LED Lights (X4), 50 Ft² Water Filter, 24Hr Circulation Pump, Auto-Fill, Drain Valve.
- » Material: 316 Stainless Steel With Powder Coat Finish

4 - WAY COPPER FIRE & WATER BOWL

- » Diameter: 30"
- » Height: 12"
- » Base Diameter: 16"
- » Ignition: Match Lit / 12VAC Electronic Ignition
- » BTU: 65,000
- » Suggested Fire Glass: 50 Lbs.
- » Bowl Includes: Fire Pan, Burner, Gas Hose, Lava Rock.
- » Bowl Material: Copper - Hammered Patina Finish
- » LED Lights And Circulation Pump (Each Require 110V To Run)
- » 80 U.S.. Gallons Required To Run Properly.



The Outdoor Plus individually handcrafts all of the products shown here. Finishes are subject to slight texture/color variations.

SELF CONTAINED UNITS



Olympian 360°

OPT-OLY60 Match Lit
OPT-OLY60EKIT Electronic Ignition

- » Overall Diameter: 60"
- » Overall Height: 36"

WATER TANK

- » Diameter: 60"
- » Height: 22"
- » Basin Depth: 12"
- » Tank Includes: LED Lights (X4), 50 Ft² Water Filter, 24Hr Circulation Pump, Auto-Fill, Drain Valve.
- » Material: 316 Stainless Steel With Powder Coat Finish

360° COPPER FIRE & WATER BOWL

- » Diameter: 30"
- » Height: 12"
- » Base Diameter: 16"
- » Ignition: Match Lit / 12VAC Electronic Ignition
- » BTU: 65,000
- » Suggested Fire Glass: 25 Lbs.
- » Bowl Includes: Fire Pan, Burner, Gas Hose, Lava Rock.
- » Bowl Material: Copper - Hammered Patina Finish
- » LED Lights And Circulation Pump (Each Require 110V To Run)
- » 80 U.S.. Gallons Required To Run Properly.



Square Olympian

OPT-OLS60S Match Lit
OPT-OLS60SEKIT Electronic Ignition

- » Overall Width: 60"
- » Overall Length: 60"
- » Overall Height: 36"

WATER TANK

- » Dimensions: 60" X 60"
- » Height: 22"
- » Basin Depth: 12"
- » Tank Includes: LED Lights (X4), 50 Ft² Water Filter, 24Hr Circulation Pump, Auto-Fill, Drain Valve.
- » Material: 316 Stainless Steel With Powder Coat Finish

4-WAY COPPER FIRE & WATER BOWL

- » Dimensions: 30" X 30"
- » Height: 12"
- » Base Dimensions: 20" X 20"
- » Ignition: Match Lit / 12VAC Electronic Ignition
- » BTU: 65,000
- » Suggested Fire Glass: 30 Lbs.
- » Bowl Includes: Fire Pan, Burner, Gas Hose, Lava Rock.
- » Bowl Material: Copper - Hammered Patina Finish
- » LED Lights And Circulation Pump (Each Require 110V To Run)
- » 95 U.S.. Gallons Required To Run Properly



The Outdoor Plus individually handcrafts all of the products shown here. Finishes are subject to slight texture/color variations.

SELF CONTAINED UNITS

Custom Sizes Available



Osiris

OPT-OSR60EKIT Electronic Ignition

- » Overall Height: 58"
- » Overall Diameter: 84"

WATER TANK

- » Basin Diameter: 72"
- » Basin Depth: 10"
- » Overhang: 6"
- » Height: 22"
- » Tank Includes: LED Lights (X4), 50 Ft² Water Filter, 24Hr Circulation Pump, Auto-Fill, Drain Valve
- » Material: 316 Stainless Steel With Powder Coat Finish

COPPER FIRE BOWL - ELECTRONIC IGNITION

- » Diameter: 24"
- » Height: 12"
- » Ignition: Match Lit / 12VAC Electronic Ignition
- » BTU: 65,000
- » No Fire Glass Or Lava Stone Required.
- » Bowl Includes: Fire Pan, Burner, Gas Hose, Lava Rock.
- » Bowl Material: Copper - Hammered Patina Finish
- » LED Lights And Circulation Pump (Each Require 110V To Run)
- » 120 U.S.. Gallons Required To Run Properly.



360° Sedona

OPT-OLYSED60 Match Lit

OPT-OLYSED60EKIT Electronic Ignition

- » Overall Diameter: 60"
- » Overall Height: 38"

WATER TANK

- » Diameter: 60"
- » Height: 22"
- » Basin Depth: 12"
- » Tank Includes: LED Lights (X4), 50 Ft² Water Filter, 24Hr Circulation Pump, Auto-Fill, Drain Valve

360 CONCRETE FIRE & WATER BOWL - ELECTRONIC IGNITION

- » Diameter: 38"
- » Height: 16"
- » Ignition: Match Lit / 12VAC Electronic Ignition
- » BTU: 65,000
- » Bowl Includes: Fire Pan, Burner, Gas Hose, Lava Rock.
- » Bowl Material: Gfrc Concrete
- » LED Lights And Circulation Pump (Each Require 110V To Run)
- » 95 U.S.. Gallons Required To Run Properly.



The Outdoor Plus individually handcrafts all of the products shown here. Finishes are subject to slight texture/color variations.

SELF CONTAINED UNITS

Custom Sizes Available

Olympian 3-Way Spill

OPT-OLY723W Match Lit
OPT-OLY723WEKIT Electronic Ignition

- » Overall Height: 58"
- » Overall Diameter: 72"

WATER TANK

- » Basin Diameter: 72"
- » Basin Depth: 10"
- » Overhang: 6"
- » Height: 22"
- » Tank Includes: LED Lights (X4), 50 Ft² Water Filter, 24Hr Circulation Pump, Auto-Fill, Drain Valve
- » Material: 316 Stainless Steel With Powder Coat Finish

COPPER FIRE BOWL - ELECTRONIC IGNITION

- » Diameter: 24"
- » Height: 12"
- » Ignition: Match Lit / 12VAC Electronic Ignition
- » BTU: 65,000
- » No Fire Glass Or Lava Stone Required.
- » Bowl Includes: Fire Pan, Burner, Gas Hose, Lava Rock.
- » Bowl Material: Copper - Hammered Patina Finish
- » LED Lights And Circulation Pump (Each Require 110V To Run)
- » 120 U.S.. Gallons Required To Run Properly.



Custom Sizes Available



19' x 3' Self Contained Fire and Water Unit
Jersey City, New Jersey

FIRE TORCHES



A. Elipse



B. Globe



C. Trojan



D. Vent



E. Hercules



F. Lantern



G. Roman



H. Flower



I. Basket



J. Urn



K. Gothic



L. Spiral



M. Tropical



N. Honeycomb



O. Havana

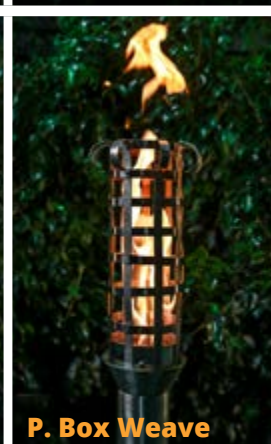

P. Box Weave



Q. Coral



R. Diamond



S. Cubist



T. Hawi



U. Comet



V. Shotgun



W. Sunshine



X. Cyclone



Y. Tiki

FIRE TORCHES

All torches are individually constructed and manufactured by hand. Built with high grade stainless steel or corten steel for durability against heat & nature's elements. All torches are for outdoor use only. NG or LP compatible. Only available in match lit ignition

#	STYLE	ORIGINAL TOP TORCHES	TOP-LITE TORCHES	DIAMETER	HEIGHT	BTU
A	Ellipse	OPT-TT1M	OPT-TCH1SS	3 3/4"	14"	20,000
B	Globe	OPT-TT2M	OPT-TCH2SS	10"	14"	20,000
C	Trojan	OPT-TT3M	OPT-TCH3SS	8"	14"	20,000
D	Vent	OPT-TT4M	OPT-TCH4SS	3 3/4"	14"	20,000
E	Hercules	OPT-TT5M	OPT-TCH5SS	8"	14"	20,000
F	Lantern	OPT-TT6M	OPT-TCH6SS	8"	14"	20,000
G	Roman	OPT-TT7M	OPT-TCH7SS	8"	14"	20,000
H	Flower	OPT-TT8M	OPT-TCH8SS	9"	14"	20,000
I	Basket	OPT-TT9M	OPT-TCH9SS	7"	14"	20,000
J	Urn	OPT-TT10M	OPT-TCH10SS	9"	14"	20,000
K	Gothic	OPT-TT11M	OPT-TCH11SS	9"	14"	20,000
L	Spiral	OPT-TT12M	OPT-TCH12SS	3 3/4"	14"	20,000
M	Tropical	OPT-TT13M	OPT-TCH13SS	3 3/4"	14"	20,000
N	Honeycomb	OPT-TT14M	OPT-TCH14SS	3 3/4"	14"	20,000
O	Havana	OPT-TT15M	OPT-TCH15SS	3 3/4"	14"	20,000
P	Box Weave	OPT-TT16M	OPT-TCH16SS	3 3/4"	14"	20,000
Q	Coral	OPT-TT17M	OPT-TCH17SS	3 3/4"	14"	20,000
R	Diamond Plate	OPT-TT18M	OPT-TCH18SS	3 3/4"	14"	20,000
S	Cubist	OPT-TT19M	OPT-TCH19SS	3 3/4"	14"	20,000
T	Hawi	OPT-TT20M	OPT-TCH20SS	3 3/4"	14"	20,000
U	Shooting Star	OPT-TT21M	OPT-TCH21SS	3 3/4"	14"	20,000
V	Shotgun	OPT-TT22M	OPT-TCH22SS	3 3/4"	14"	20,000
W	Sunshine	OPT-TT23M	OPT-TCH23SS	3 3/4"	14"	20,000
X	Cyclone	OPT-TT24M	OPT-TCH24SS	3 3/4"	14"	20,000
Y	Tiki	OPT-TT25M	OPT-TCH25SS	3 3/4"	14"	20,000



Original TOP Torches: Inside is a built-in needle valve for precise flame adjustment. Torches can be fitted onto any 2 1/2" post with hex bolts that are on the barrel. 3/8" flared gas inlet



Top-Lite Torches: Designed for easy and fast installation. Torches have a female 1/2" gas inlet. Top-Lite Torches can be fitted onto any 1/2" gas pipe with threading. No needle valve.

OPTIONAL ACCESSORIES



Deck Post OPT-TTDP

Deck post mounting plate.

Material: Steel
Finish: Powder Coat
Opening: 2 5/8"
Post sold separately



Torch Stand OPT-TTSTD

Includes Torch stand, manual gas shut off valve, LP regulator

TOP LITE TORCHES ONLY

Material: Steel
Finish: Powder Coat
Width: 24"
Depth: 24"
Total Height: 78"
Gas Connection: 3/4"



Propane Tank Cover OPT-LPCOVER

Black Canvas Cover.
Fits a standard 20 lbs Propane Tank

In-Ground Post OPT-TTBP

Material: Aluminum
Finish: Powder Coat
Diameter: 2 1/2"
Total Height: 80"
- 16" Anchor Post
- 68" Post

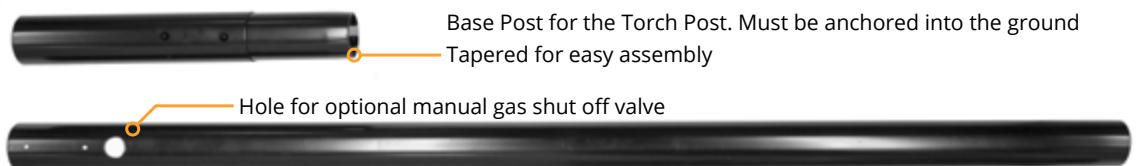

Base Post for the Torch Post. Must be anchored into the ground
Tapered for easy assembly

Hole for optional manual gas shut off valve

FIRE TOWERS

All fire towers are constructed from high grade steel, copper or corten steel. Each tower comes equipped with all components necessary for plug and play application, just provide the gas. Each unit is individually handcrafted and finish may vary slightly. Due to the natural properties of copper and corten steel, its exterior will patina and change color over time.



Granada Fire Tower

OPT-FTWR1 Match Lit
OPT-FTWR1EKIT Electronic Ignition

- » Dimensions: 22" X 22"
- » Height: 68"
- » Weight: 95 Lbs.
- » BTU: 40,000
- » Material: Galvanized Steel
- » Finish: Powder-Coated
- » No Fire Glass Required
- » Items Included: Burner, Key Valve, Key, Gas Hoses.
- » Propane Tank Storage: Yes



Bastille Corten Tower

OPT-FTWR2 Match Lit
OPT-FTWR2EKIT Electronic Ignition

- » Dimensions: 24" x 24"
- » Height: 87"
- » Weight: 145 Lbs.
- » BTU: 40,000
- » Material: Corten Steel
- » Finish: Weathered Corten Steel
- » No Fire Glass Required
- » Items Included: Burner, Key Valve, Key, Gas Hoses.
- » Propane Tank Storage: Yes



Bastille Copper Tower

OPT-FTWR3 Match Lit
OPT-FTWR3EKIT Electronic Ignition

- » Dimensions: 24" x 24"
- » Height: 87"
- » Weight: 128 Lbs.
- » BTU: 40,000
- » Material: Copper
- » Finish: Hammered Patina
- » No Fire Glass Required
- » Items Included: Burner, Key Valve, Key, Gas Hoses.
- » Propane Tank Storage: Yes

The Outdoor Plus individually handcrafts all of the products shown here. Finishes are subject to slight texture/color variations.

CUSTOM 6' STAINLESS STEEL FIRE TOWER BY

TOPFIRES

BY THE OUTDOOR PLUS

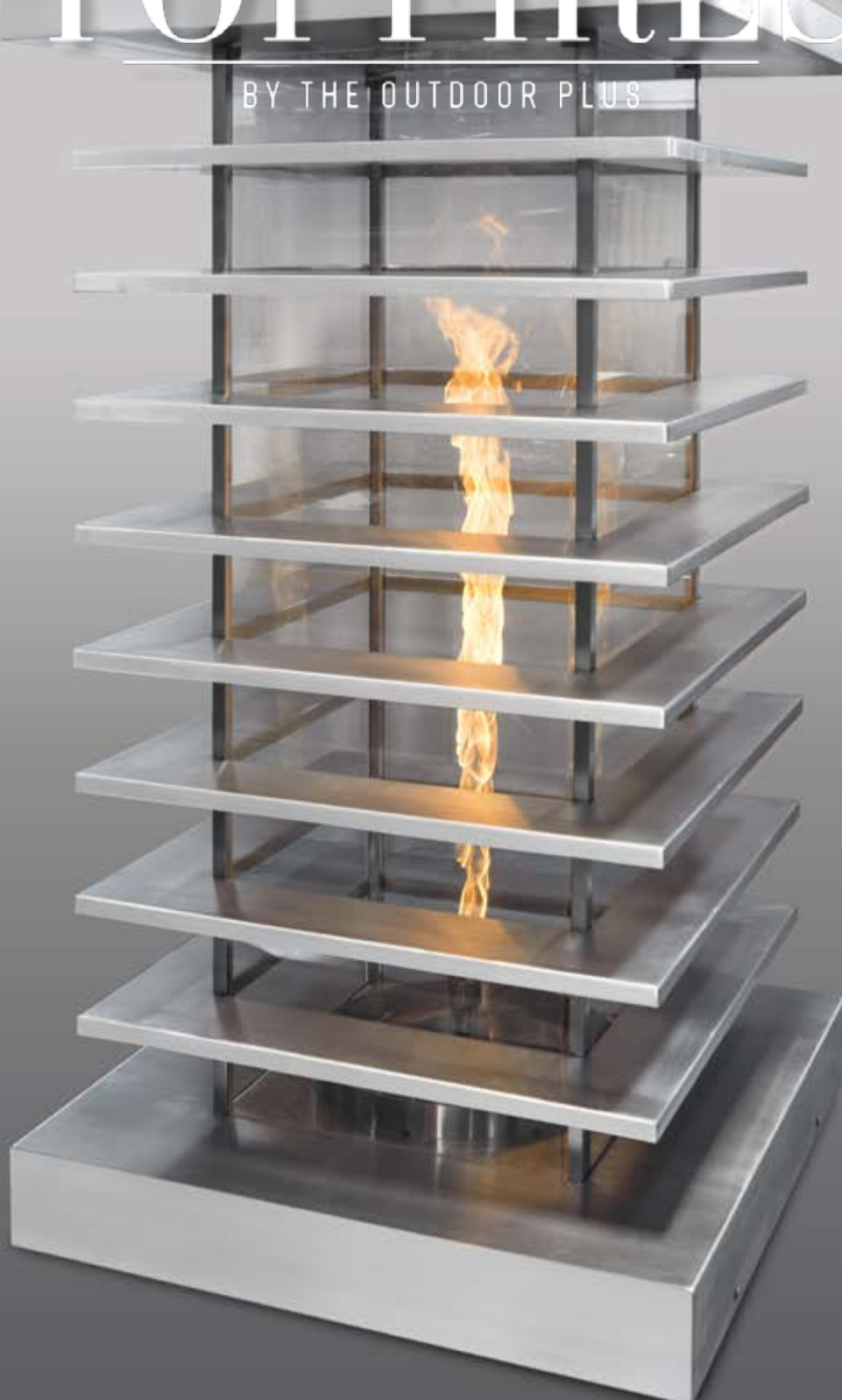

FOR MORE INFORMATION ABOUT CUSTOM UNITS, VISIT PAGE 112 OR SEND AN INQUIRY ON OUR WEBSITE AT THEOUTDOORPLUS.COM/CUSTOM

CORTEN STEEL PLANTERS



Vertical Tuscon Planter

SKU	DIAMETER	BASE	HEIGHT	SOIL USAGE
OPT-PTST2624	26" x 26"	16" X 16"	34"	12.5 ft. ³
OPT-PTST3034	30" X 30"	20" X 20"	34"	16 ft. ³



Tuscon Planter

SKU	DIMENSIONS	BASE	HEIGHT	SOIL USAGE
OPT-PTSS24	24" X 24"	14" X 14"	14"	3.5 ft. ³
OPT-PTSS30	30" x 30"	18" x 18"	18"	6.75 ft. ³



Rectangular Tuscon Planter

SKU	DIMENSIONS	BASE	HEIGHT	SOIL USAGE
OPT-PTSR4824	48" X 24"	40" X 16"	24"	14.5 ft. ³



The Outdoor Plus individually handcrafts all of the products shown here. Finishes are subject to slight texture/color variations.

CORTEN STEEL PLANTERS



Moderna Rectangular Planter

SKU	DIMENSIONS	HEIGHT	SOIL USAGE
OPT-PMDR4824	48" X 24"	14"	9.25 ft. ³
OPT-PMDR6024	60" X 24"	14"	11.75 ft. ³



Moderna Square Planter

SKU	DIMENSIONS	HEIGHT	SOIL USAGE
OPT-PMD2014	20" X 20"	14"	3.25 ft. ³
OPT-PMD2414	24" X 24"	14"	4.75 ft. ³
OPT-PMD3020	30" X 30"	20"	10.5 ft. ³



Sierra Planter - 30" Tall

SKU	DIAMETER	BASE	HEIGHT	SOIL USAGE
OPT-PSR3030	30"	18"	30"	8 ft. ³
OPT-PSR4830	46"	30"	30"	20 ft. ³

Sierra Planter - 20" Tall

SKU	DIAMETER	BASE	HEIGHT	SOIL USAGE
OPT-PSR3020	30"	18"	20"	5.5 ft. ³
OPT-PSR4820	46"	30"	20"	13.5 ft. ³

The Outdoor Plus individually handcrafts all of the products shown here. Finishes are subject to slight texture/color variations.

WOOD GRAIN FIRE PITS



48" Ivory Shown



108" Ebony Shown

Coronado Fire Pit

OPT-COR48 Match Lit
OPT-COR48EKIT Electronic Ignition

- » Dimensions: 48" x 28"
- » Height: 15"
- » Burning Area: 30" x 10"
- » Toe Kick: 3" x 2"
- » Weight: 235 lbs.
- » BTU: 65,000
- » Suggested Fire Glass: 50 lbs.

OPT-COR60 Match Lit
OPT-COR60EKIT Electronic Ignition

- » Dimensions: 60" x 28"
- » Height: 15"
- » Burning Area: 42" x 10"
- » Toe Kick: 5" x 5"
- » Weight: 375 lbs.
- » BTU: 65,000
- » Suggested Fire Glass: 50 lbs.

OPT-COR72 Match Lit
OPT-COR72EKIT Electronic Ignition

- » Dimensions: 72" x 28"
- » Height: 15"
- » Burning Area: 54" x 10"
- » Toe Kick: 5" x 5"
- » Weight: 455 lbs.
- » BTU: 80,000
- » Suggested Fire Glass: 75 lbs.

OPT-COR84 Match Lit
OPT-COR84EKIT Electronic Ignition

- » Dimensions: 84" x 28"
- » Height: 15"
- » Burning Area: 66" x 10"
- » Toe Kick: 5" x 5"
- » Weight: 610 lbs.
- » BTU: 100,000
- » Suggested Fire Glass: 100 lbs.

OPT-COR96 Match Lit
OPT-COR96EKIT Electronic Ignition

- » Dimensions: 96" x 28"
- » Height: 15"
- » Burning Area: 78" x 10"
- » Toe Kick: 5" x 5"
- » Weight: 690 lbs.
- » BTU: 120,000
- » Suggested Fire Glass: 100 lbs.

OPT-COR108 Match Lit
OPT-COR108EKIT Electronic Ignition

- » Dimensions: 108" x 28"
- » Height: 15"
- » Burning Area: 90" x 10"
- » Toe Kick: 5" x 5"
- » Weight: 765 lbs.
- » BTU: 140,000
- » Suggested Fire Glass: 125 lbs.

OPT-COR120 Match Lit
OPT-COR120EKIT Electronic Ignition

- » Dimensions: 120" x 28"
- » Height: 15"
- » Burning Area: 102" x 10"
- » Toe Kick: 5" x 5"
- » Weight: 835 lbs.
- » BTU: 160,000
- » Suggested Fire Glass: 125 lbs.

- » Material: GFRC Concrete
- » Finish: Wood Grain Texture
- » All Fire Pits Include: Fire Pan, Burner, Key Valve, Key, Hoses, Lava Rock.
- » Propane Tank Storage: No

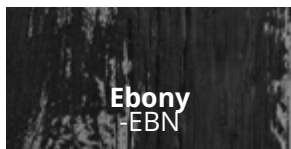

GFRC Wood Grain Color Options

When ordering, specify the GFRC Wood Grain color by adding the color code to the end of the part number. (see swatches to the left)

Example: Big Sur Fire Pit in Ivory = OPT-COR48-IVY



48" Coronado - Ivory Finish



60" Coronado - Oak Finish

WOOD GRAIN FIRE PITS



48" Oak Shown



96" Ivory Shown

Catalina Fire Pit

OPT-CTL48 Match Lit
OPT-CTL48EKIT Electronic Ignition

- » Dimensions: 48" x 28"
- » Height: 24"
- » Burning Area: 30" x 10"
- » Toe Kick: 3" x 2"
- » Weight: 310 lbs.
- » BTU: 65,000
- » Suggested Fire Glass: 50 lbs.

OPT-CTL60 Match Lit
OPT-CTL60EKIT Electronic Ignition

- » Dimensions: 60" x 28"
- » Height: 24"
- » Burning Area: 42" x 12"
- » Toe Kick: 5" x 5"
- » Weight: 375 lbs.
- » BTU: 65,000
- » Suggested Fire Glass: 50 lbs.

OPT-CTL72 Match Lit
OPT-CTL72EKIT Electronic Ignition

- » Dimensions: 72" x 28"
- » Height: 24"
- » Burning Area: 54" x 12"
- » Toe Kick: 5" x 5"
- » Weight: 590 lbs.
- » BTU: 80,000
- » Suggested Fire Glass: 75 lbs.

OPT-CTL84 Match Lit
OPT-CTL84EKIT Electronic Ignition

- » Dimensions: 84" x 28"
- » Height: 24"
- » Burning Area: 66" x 12"
- » Toe Kick: 5" x 5"
- » Weight: 685 lbs.
- » BTU: 100,000
- » Suggested Fire Glass: 100 lbs.

OPT-CTL96 Match Lit
OPT-CTL96EKIT Electronic Ignition

- » Dimensions: 96" x 28"
- » Height: 24"
- » Burning Area: 78" x 12"
- » Toe Kick: 5" x 5"
- » Weight: 800 lbs.
- » BTU: 125,000
- » Suggested Fire Glass: 100 lbs.

OPT-CTL108 Match Lit
OPT-CTL108EKIT Electronic Ignition

- » Dimensions: 108" x 28"
- » Height: 24"
- » Burning Area: 90" x 12"
- » Toe Kick: 5" x 5"
- » Weight: 890 lbs.
- » BTU: 140,000
- » Suggested Fire Glass: 125 lbs.

OPT-CTL120 Match Lit
OPT-CTL120EKIT Electronic Ignition

- » Dimensions: 120" x 28"
- » Height: 24"
- » Burning Area: 102" x 12"
- » Toe Kick: 5" x 5"
- » Weight: 995 lbs.
- » BTU: 160,000
- » Suggested Fire Glass: 125 lbs.

- » Material: GFRC Concrete
- » Finish: Wood Grain Texture
- » All Fire Pits Include: Fire Pan, Burner, Key Valve, Key, Hoses, Lava Rock.
- » Propane Tank Storage: Yes

The Outdoor Plus individually handcrafts all of the products shown here. Finishes are subject to slight texture/color variations.



48" Catalina - Oak Finish



48" Catalina - Ivory Finish

WOOD GRAIN FIRE PIT



120" Ivory Shown

Laguna Fire Table

OPT-LGNGF120 Match Lit
OPT-LGNGF120EKIT Electronic Ignition

- » Dimensions: 120" x 60"
- » Height: 42"
- » Burning Area: 78" x 12"
- » Overhang: 12"
- » Weight: 1465 lbs.
- » BTU: 120,000
- » Suggested Fire Glass: 125 lbs.

- » Material: GFRC Concrete
- » Finish: Wood Grain Texture
- » All Fire Pits Include: Fire Pan, Burner, Key Valve, Key, Hoses, Lava Rock.
- » Propane Tank Storage: Yes

OPT-LGNGF144 Match Lit
OPT-LGNGF144EKIT Electronic Ignition

- » Dimensions: 144" x 60"
- » Height: 42"
- » Burning Area: 102" x 12"
- » Overhang: 12"
- » Weight: 1750 lbs.
- » BTU: 160,000
- » Suggested Fire Glass: 175 lbs.



72" Ivory Shown

Big Sur Fire Pit

OPT-BGSR60 Match Lit
OPT-BGSR60EKIT Electronic Ignition

- » Dimensions: 60" x 28"
- » Height: 24"
- » Burning Area: 42" x 10"
- » Weight: 345 lbs.
- » BTU: 65,000
- » Suggested Fire Glass: 50 lbs.

OPT-BGSR72 Match Lit
OPT-BGSR72EKIT Electronic Ignition

- » Dimensions: 72" x 28"
- » Height: 24"
- » Burning Area: 54" x 10"
- » Weight: 425 lbs.
- » BTU: 65,000
- » Suggested Fire Glass: 75 lbs.

- » Material: GFRC Concrete
- » Finish: Wood Grain Texture
- » All Fire Pits Include: Fire Pan, Burner, Key Valve, Key, Hoses, Lava Rock.
- » Propane Tank Storage: Yes

The Outdoor Plus individually handcrafts all of the products shown here. Finishes are subject to slight texture/color variations.

OUTDOOR SEATING



The Grove Love Seat

OPT-LSWG01

- » Width: 56"
- » Depth: 30"
- » Height: 33"
- » Seating Area Width: 45 ½"
- » Seating Area Depth: 23 ½"
- » Material: GFRC Concrete
- » Finish: Wood Grain Texture



The Grove Arm Chair

OPT-ACWG01

- » Width: 30"
- » Depth: 30"
- » Height: 33"
- » Seating Area Width: 20 ½"
- » Seating Area Depth: 23 ½"
- » Material: GFRC Concrete
- » Finish: Wood Grain Texture



The Grove Fire Pit

OPT-GRVWG60

Match Lit

OPT-GRVWG60EKIT

Electronic Ignition

- » Dimensions: 60" x 28"
- » Height: 24"
- » Burning Area: 30" x 10"
- » Overhang:
- » Weight: 235 lbs.
- » BTU: 65,000
- » Suggested Fire Glass: # lbs.
- » Material: GFRC Concrete
- » Finish: Wood Grain Texture
- » All fire pits include: Fire pan, burner, key valve, key, hoses, lava rock.
- » Propane Tank Storage: Yes

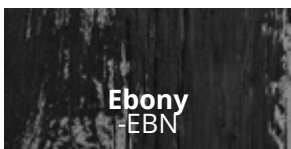

Ebony
-EBN



Ivory
-IVY



Oak
-OAK

GFRC Wood Grain Color Options

When ordering, specify the GFRC Wood Grain color by adding the color code to the end of the part number. (see swatches to the left)

Example: Big Sur Fire Pit in Ivory = OPT-COR48-IVY

The Outdoor Plus individually handcrafts all of the products shown here. Finishes are subject to slight texture/color variations.

FIRE PITS & FIRE TABLES

GFRC Concrete

[Click to Return to Table of Contents](#)



FIRE PITS & FIRE TABLES

Newport Fire Table

OPT-NPTT120 Match Lit
OPT-NPTT120EKIT Electronic Ignition

- » Dimensions: 120" x 48"
- » Height: 30"
- » Burning Area: 78" x 12"
- » Overhang: 12"
- » Weight: 1465 lbs.
- » BTUs: 120,000
- » Suggested Fire Glass: 125 lbs.

OPT-NPTT144 Match Lit
OPT-NPTT144EKIT Electronic Ignition

- » Dimensions: 144" x 48"
- » Height: 30"
- » Burning Area: 102" x 12"
- » Overhang: 12"
- » Weight: 1750 lbs.
- » BTU: 160,000
- » Suggested Fire Glass: 175 lbs.
- » Material: GFRC Concrete
- » Finish: Wood Grain Texture
- » All Fire Pits Include: Fire Pan, Burner, Key Valve, Key, Hoses, Lava Rock.
- » Propane Tank Storage: Yes



The Outdoor Plus individually handcrafts all of the products shown here. Finishes are subject to slight texture/color variations.

Metallic Finishes and Rustic Finishes are available at an extra charge

When ordering, specify the concrete color by adding the color code to the end of the part number. Example: 24" Black Maya Water Bowl = OPT-24SWO-BLK

Black -BLK	Ash -ASH	Natural Gray -NGY	Gray -GRY	White Limestone -LIM	Chocolate -CHC	Chestnut -CST	Brown -BRN	Vanilla -VAN
Rustic Gray -RGR	Moss Stone -RMS	Rustic White -RWH	Coffee -RCF	Slate -MSL	Silver -MSV	Pearl -MPR	Bronze -MBR	Copper -MCP

LA PINTA 5' FIRE PIT & ORNAMENT

FOR MORE INFORMATION ABOUT
 CUSTOM UNITS, VISIT PAGE 112 OR SEND
 AN INQUIRY ON OUR WEBSITE
 AT THEOUTDOORPLUS.COM/CUSTOM



FIRE PITS & FIRE TABLES

Custom Sizes Available



Gray Finish Shown

Cazo Fire Pit - Wide Ledge

OPT-CZ48
OPT-CZ48EKIT

Match Lit
Electronic Ignition

- » Diameter: 48"
- » Height: 17"
- » Base Diameter: 20"
- » Burn Area Diameter: 29"
- » Weight: 260 lbs.
- » BTU: 65,000
- » Suggested Fire Glass: 75 lbs.
- » Material: GFRC Concrete
- » Finish: Smooth Finish Concrete
- » Items Included: Fire Pan, Burner, Key Valve, Key, Hoses, Lava Rock
- » Propane Tank Storage: No

OPT-CZ60
OPT-CZ60EKIT

Match Lit
Electronic Ignition

- » Diameter: 60"
- » Height: 20"
- » Base Diameter: 28"
- » Burn Area Diameter: 40"
- » Weight: 315 lbs.
- » BTU: 65,000
- » Suggested Fire Glass: 125 lbs.

Sienna Fire Pit

OPT-RF37
OPT-RF37EKIT

Match Lit
Electronic Ignition

- » Diameter: 37"
- » Height: 25"
- » Base Diameter: 17.5"
- » Burn Area Diameter: 20"
- » Weight: 285 lbs.
- » BTU: 65,000
- » Suggested Fire Glass: 25 lbs.
- » Material: GFRC Concrete
- » Finish: Smooth Finish Concrete
- » Items Included: Fire Pan, Burner, Key Valve, Key, Hoses, Lava Rock
- » Propane Tank Storage: No



Chestnut Finish Shown

FIRE PITS & FIRE TABLES



Chestnut Finish Shown

Cazo Fire Pit - No Ledge

OPT-CZNL48 Match Lit
OPT-CZNL48EKIT Electronic Ignition

- » Diameter: 48"
- » Height: 16"
- » Base Diameter: 20"
- » Burn Area Diameter: 43"
- » Weight: 260 lbs.
- » BTU: 65,000
- » Suggested Fire Glass: 150 lbs.
- » Material: GFRC Concrete
- » Finish: Smooth Finish Concrete
- » Items Included: fire pan, burner, key valve, key, hoses, lava rock
- » Propane Tank Storage: No

OPT-CZNL60 Match Lit
OPT-CZNL60EKIT Electronic Ignition

- » Diameter: 60"
- » Height: 20"
- » Base Diameter: 28"
- » Burn Area Diameter: 50"
- » Weight: 315 lbs.
- » BTU: 65,000
- » Suggested Fire Glass: 200 lbs.



Brown Finish Shown

Sonoma Fire Pit

OPT-SONMA38 Match Lit
OPT-SONMA38EKIT Electronic Ignition

- » Diameter: 38"
- » Height: 25"
- » Base Diameter: 17.5"
- » Burn Area Diameter: 32"
- » Weight: 285 lbs.
- » BTU: 65,000
- » Suggested Fire Glass: 75 lbs.
- » Material: GFRC Concrete
- » Finish: Smooth Finish Concrete
- » Items Included: fire pan, burner, key valve, key, hoses, lava rock
- » Propane Tank Storage: No



Vanilla Finish Shown

Tempe Fire Pit

OPT-TEM48 Match Lit
OPT-TEM48EKIT Electronic Ignition

- » Diameter: 48"
- » Height: 16"
- » Burn Area Diameter: 26"
- » Weight: 370 lbs.
- » BTU: 65,000
- » Suggested Fire Glass: 50 lbs.
- » Material: GFRC Concrete
- » Finish: Smooth Finish Concrete
- » Items Included: fire pan, burner, key valve, key, hoses, lava rock
- » Propane Tank Storage: No

The Outdoor Plus individually handcrafts all of the products shown here. Finishes are subject to slight texture/color variations. Metallic Finishes and Rustic Finishes are available at an extra charge

When ordering, specify the concrete color by adding the color code to the end of the part number. **Example:** 24" Black Maya Water Bowl = OPT-24SWO-BLK

Black -BLK	Ash -ASH	Natural Gray -NGY	Gray -GRY	White Limestone -LIM	Chocolate -CHC	Chestnut -CST	Brown -BRN	Vanilla -VAN
Rustic Gray -RGR	Moss Stone -RMS	Rustic White -RWH	Coffee -RCF	Slate -MSL	Silver -MSV	Pearl -MPR	Bronze -MBR	Copper -MCP

FIRE PITS & FIRE TABLES



Chestnut Finish Shown

Sedona Fire Pit

- | | | | |
|----------------------|---------------------|----------------------|---------------------|
| OPT-SED48 | Match Lit | OPT-SED60 | Match Lit |
| OPT-SED48EKIT | Electronic Ignition | OPT-SED60EKIT | Electronic Ignition |
- » Diameter: 48"
 - » Height: 15"
 - » Base Diameter: 27
 - » Burn Area Diameter: 40"
 - » Weight: 215 lbs.
 - » BTU: 65,000
 - » Suggested Fire Glass: 150 lbs.
 - » Material: GFRC Concrete
 - » Finish: Smooth Finish Concrete
 - » Items Included: Fire Pan, Burner, Key Valve, Key, Hoses, Lava Rock
 - » Propane Tank Storage: No
- | | | | | | | |
|-----------------|---------------|----------------------|---------------------------|--------------------|---------------|----------------------------------|
| » Diameter: 60" | » Height: 17" | » Base Diameter: 31" | » Burn Area Diameter: 53" | » Weight: 300 lbs. | » BTU: 65,000 | » Suggested Fire Glass: 200 lbs. |
|-----------------|---------------|----------------------|---------------------------|--------------------|---------------|----------------------------------|



Brown Finish Shown

Sedona Fire Pit - Wide Ledge

- | | | | |
|------------------------|---------------------|------------------------|---------------------|
| OPT-SEDWL48 | Match Lit | OPT-SEDWL60 | Match Lit |
| OPT-SEDWL48EKIT | Electronic Ignition | OPT-SEDWL60EKIT | Electronic Ignition |
- » Diameter: 48"
 - » Height: 15"
 - » Base Diameter: 27
 - » Burn Area Diameter: 29"
 - » Weight: 215 lbs.
 - » BTU: 65,000
 - » Suggested Fire Glass: 100 lbs.
 - » Material: GFRC Concrete
 - » Finish: Smooth Finish Concrete
 - » Items Included: Fire Pan, Burner, Key Valve, Key, Hoses, Lava Rock
 - » Propane Tank Storage: No
- | | | | | | | |
|-----------------|---------------|----------------------|---------------------------|--------------------|---------------|----------------------------------|
| » Diameter: 60" | » Height: 15" | » Base Diameter: 38" | » Burn Area Diameter: 40" | » Weight: 300 lbs. | » BTU: 65,000 | » Suggested Fire Glass: 150 lbs. |
|-----------------|---------------|----------------------|---------------------------|--------------------|---------------|----------------------------------|



30" Ash Finish Shown

Luna Fire Pit

- | | | | |
|----------------------|---------------------|----------------------|---------------------|
| OPT-LUN30 | Match Lit | OPT-LUN38 | Match Lit |
| OPT-LUN30EKIT | Electronic Ignition | OPT-LUN38EKIT | Electronic Ignition |
- » Diameter: 30"
 - » Height: 14.5"
 - » Base Diameter: 13"
 - » Burn Area Diameter: 24"
 - » Weight: 140 lbs.
 - » BTU: 65,000
 - » Suggested Fire Glass: 50 lbs.
 - » Material: GFRC Concrete
 - » Finish: Smooth Finish Concrete
 - » Items Included: Fire Pan, Burner, Key Valve, Key, Hoses, Lava Rock
 - » Propane Tank Storage: No
- | | | | | | | |
|-----------------|-----------------|----------------------|---------------------------|--------------------|---------------|---------------------------------|
| » Diameter: 38" | » Height: 16.5" | » Base Diameter: 16" | » Burn Area Diameter: 30" | » Weight: 285 lbs. | » BTU: 65,000 | » Suggested Fire Glass: 75 lbs. |
|-----------------|-----------------|----------------------|---------------------------|--------------------|---------------|---------------------------------|

The Outdoor Plus individually handcrafts all of the products shown here. Finishes are subject to slight texture/color variations. Metallic Finishes and Rustic Finishes are available at an extra charge

When ordering, specify the concrete color by adding the color code to the end of the part number. **Example:** 24" Black Maya Water Bowl = OPT-24SWO-BLK

Black -BLK	Ash -ASH	Natural Gray -NGY	Gray -GRY	White Limestone -LIM	Chocolate -CHC	Chestnut -CST	Brown -BRN	Vanilla -VAN
Rustic Gray -RGR	Moss Stone -RMS	Rustic White -RWH	Coffee -RCF	Slate -MSL	Silver -MSV	Pearl -MPR	Bronze -MBR	Copper -MCP

FIRE PITS & FIRE TABLES



Chocolate Finish Shown

42" Florence Fire Table - 24" Tall

OPT-FL4224 Match Lit
OPT-FL4224EKIT Electronic Ignition

- » Diameter: 42"
- » Height: 24"
- » Burn Area Diameter: 25"
- » Weight: 425 lbs.
- » BTU: 65,000
- » Suggested Fire Glass: 55 lbs.
- » Material: GFRC Concrete
- » Finish: Smooth Finish Concrete
- » Items Included: Fire Pan, Burner, Key Valve, Key, Hoses, Lava Rock
- » Propane Tank Storage: Yes



Limestone Finish Shown

42" Florence Fire Pit

OPT-FL42 Match Lit
OPT-FL42EKIT Electronic Ignition

- » Diameter: 42"
- » Height: 12"
- » Burn Area Diameter: 25"
- » Weight: 315 lbs.
- » BTU: 65,000
- » Suggested Fire Glass: 50 lbs.
- » Material: GFRC Concrete
- » Finish: Smooth Finish Concrete
- » Items Included: Fire Pan, Burner, Key Valve, Key, Hoses, Lava Rock
- » Propane Tank Storage: No

The Outdoor Plus individually handcrafts all of the products shown here. Finishes are subject to slight texture/color variations.



Ash Finish Shown

54" & 72" Florence Fire Pit

OPT-FL54 Match Lit
OPT-FL54EKIT Electronic Ignition

- » Diameter: 54"
- » Height: 20"
- » Burn Area Diameter: 30"
- » Weight: 490 lbs.
- » BTU: 65,000
- » Suggested Fire Glass: 100 lbs.
- » Propane Tank Storage

OPT-FL72 Match Lit
OPT-FL72EKIT Electronic Ignition

- » Diameter: 72"
- » Height: 20"
- » Burn Area Diameter: 48"
- » Weight: 675 lbs.
- » BTU: 65,000
- » Suggested Fire Glass: 100 lbs.
- » Propane Tank Storage

- » Material: GFRC Concrete
- » Finish: Smooth Finish Concrete
- » Items Included: Fire Pan, Burner, Key Valve, Key, Hoses, Lava Rock
- » Propane Tank Storage: Yes

FIRE PITS & FIRE TABLES



Regal Fire Pit

OPT-RGL48 Match Lit
OPT-RGL48EKIT Electronic Ignition

- » Dimensions: 48" x 24"
- » Height: 13"
- » Burning Area: 34" x 10" x 2"
- » Weight: 195 lbs.
- » BTU: 45,000
- » Suggested Fire Glass: 50 lbs.
- » Material: GFRC Concrete
- » Finish: Smooth Finish Concrete
- » Items Included: Fire Pan, Burner, Key Valve, Key, Hoses, Lava Rock
- » Propane Tank Storage: No

OPT-RGL54 Match Lit
OPT-RGL54EKIT Electronic Ignition

- » Dimensions: 54" x 24"
- » Height: 13"
- » Burning Area: 40" x 10" x 2"
- » Weight: 215 lbs.
- » BTU: 65,000
- » Suggested Fire Glass 50 lbs.

OPT-RGL60 Match Lit
OPT-RGL60EKIT Electronic Ignition

- » Dimensions: 60" x 24"
- » Height: 13"
- » Burning Area: 48" x 10" x 2"
- » Weight: 240 lbs.
- » BTU: 65,000
- » Suggested Fire Glass: 75 lbs.



Quad Fire Pit

OPT-QD36 Match Lit
OPT-QD36EKIT Electronic Ignition

- » Dimensions: 36" x 36"
- » Height: 12"
- » Burning Area: 28" x 28" x 2"
- » Weight: 180 lbs.
- » BTU: 65,000
- » Suggested Fire Glass: 75 lbs.

OPT-QD42 Match Lit
OPT-QD42EKIT Electronic Ignition

- » Dimensions: 42" x 42"
- » Height: 12"
- » Burning Area: 34" x 34" x 2"
- » Weight: 215 lbs.
- » BTU: 65,000
- » Suggested Fire Glass: 125 lbs.

- » Material: GFRC Concrete
- » Finish: Smooth Finish Concrete
- » Items Included: Fire Pan, Burner, Key Valve, Key, Hoses, Lava Rock
- » Propane Tank Storage: No

The Outdoor Plus individually handcrafts all of the products shown here. Finishes are subject to slight texture/color variations.

Metallic Finishes and Rustic Finishes are available at an extra charge

When ordering, specify the concrete color by adding the color code to the end of the part number. **Example:** 24" Black Maya Water Bowl = OPT-24SWO-BLK

Black -BLK	Ash -ASH	Natural Gray -NGY	Gray -GRY	White Limestone -LIM	Chocolate -CHC	Chestnut -CST	Brown -BRN	Vanilla -VAN
Rustic Gray -RGR	Moss Stone -RMS	Rustic White -RWH	Coffee -RCF	Slate -MSL	Silver -MSV	Pearl -MPR	Bronze -MBR	Copper -MCP

FIRE PITS & FIRE TABLES



Del Mar Fire Pit

OPT-CORGFRC48 Match Lit
OPT-CORGFRC48EKIT Electronic Ignition

- » Dimensions: 48" x 28"
- » Height: 15"
- » Base Dimensions: 38" x 18"
- » Burning Area: 30" x 10"
- » Weight: 175 lbs.
- » BTU: 45,000
- » Suggested Fire Glass: 50 lbs.

OPT-DEL6028 Match Lit
OPT-DEL6028EKIT Electronic Ignition

- » Dimensions: 60" x 28"
- » Height: 15"
- » Base Dimensions: 50" x 18"
- » Burning Area: 42" x 10"
- » Weight: 195 lbs.
- » BTU: 65,000
- » Suggested Fire Glass: 50 lbs.

OPT-DEL7228 Match Lit
OPT-DEL7228EKIT Electronic Ignition

- » Dimensions: 72" x 28"
- » Height: 15"
- » Base Dimensions: 62" x 18"
- » Burning Area: 54" x 10"
- » Weight: 225 lbs.
- » BTU: 65,000
- » Suggested Fire Glass: 75 lbs.

OPT-DEL8428 Match Lit
OPT-DEL8428EKIT Electronic Ignition

- » Dimensions: 84" x 28"
- » Height: 15"
- » Base Dimensions: 74" x 18"
- » Burning Area: 66" x 10"
- » Weight: 245 lbs.
- » BTU: 110,000
- » Suggested Fire Glass: 100 lbs.

OPT-DEL9628 Match Lit
OPT-DEL9628EKIT Electronic Ignition

- » Dimensions: 96" x 28"
- » Height: 15"
- » Base Dimensions: 86" x 18"
- » Burning Area: 78" x 10"
- » Weight: 270 lbs.
- » BTU: 135,000
- » Suggested Fire Glass: 100 lbs.

- » Material: GFRC Concrete
- » Finish: Smooth Finish Concrete
- » Items Included: Fire Pan, Burner, Key Valve, Key, Hoses, Lava Rock
- » Propane Tank Storage: No



Redan Fire Pit

OPT-RDN36 Match Lit
OPT-RDN36EKIT Electronic Ignition

- » Dimensions: 36" x 36"
- » Height: 24"
- » Burning Area: 24" x 24"
- » Weight: 330 lbs.
- » BTU: 65,000
- » Suggested Fire Glass: 75 lbs.
- » Material: GFRC Concrete
- » Finish: Smooth Finish Concrete
- » Items Included: Fire Pan, Burner, Key Valve, Key, Hoses, Lava Rock
- » Propane Tank Storage: Yes

OPT-RDN50 Match Lit
OPT-RDN50EKIT Electronic Ignition

- » Dimensions: 50" x 50"
- » Height: 24"
- » Burning Area: 29" x 29"
- » Weight: 455 lbs.
- » BTU: 65,000
- » Suggested Fire Glass: 100 lbs.

The Outdoor Plus individually handcrafts all of the products shown here. Finishes are subject to slight texture/color variations.

FIRE PITS & FIRE TABLES



Pismo Fire Pit

OPT-2448

Match Lit

OPT-2448EKIT

Electronic Ignition

OPT-2460

Match Lit

OPT-2460EKIT

Electronic Ignition

- » Dimension: 48" x 24"
 - » Height: 24"
 - » Burning Area: 31" x 11" x 2"
 - » Toe Kick: 2" x 2"
 - » Weight: 315 lbs.
 - » BTU: 65,000
 - » Suggested Fire Glass: 50 lbs.
 - » Material: GFRC Concrete
 - » Finish: Smooth Finish Concrete
 - » Items Included: Fire Pan, Burner, Key Valve, Key, Hoses, Lava Rock
 - » Propane Tank Storage: Yes
- » Dimension: 60" x 24"
 - » Height: 24"
 - » Burning Area: 42" x 11" x 2"
 - » Toe Kick: 2" x 2"
 - » Weight: 395 lbs.
 - » BTU: 65,000
 - » Suggested Fire Glass: 50 lbs.



Linear Ramona Fire Pit

OPT-RMNRT60

Match Lit

OPT-RMNRT60EKIT

Electronic Ignition

- » Dimensions: 60" x "24
- » Height: 24"
- » Base: 54" x 18"
- » Burn Area: 48" x 12" x 2"
- » Weight: 395 lbs.
- » BTU: 65,000
- » Suggested Fire Glass: 50 lbs.
- » Material: GFRC Concrete
- » Finish: Smooth Finish Concrete
- » Items Included: Fire Pan, Burner, Key Valve, Key, Hoses, Lava Rock
- » Propane Tank Storage: Yes



Square Ramona Fire Pit

OPT-RMNSQ36

Match Lit

OPT-RMNSQ36EKIT

Electronic Ignition

- » Dimensions: 36" x 36"
- » Height: 24"
- » Base: 30" x 30"
- » Burn Area: 17" x 17" x 2"
- » Weight: 355 lbs.
- » BTU: 65,000
- » Suggested Fire Glass: 25 lbs.
- » Material: GFRC Concrete
- » Finish: Smooth Finish Concrete
- » Items Included: Fire Pan, Burner, Key Valve, Key, Hoses, Lava Rock
- » Propane Tank Storage: Yes

The Outdoor Plus individually handcrafts all of the products shown here. Finishes are subject to slight texture/color variations.

FIRE PITS & FIRE TABLES



Angelus Fire Pit

OPT-AGLGF60 Match Lit
OPT-AGLGF60EKIT Electronic Ignition

- » Dimensions: 60" x 36"
- » Height: 24"
- » Base: 50" x 24"
- » Burn Area: 48" x 10" x 2"
- » Weight: 395 lbs.
- » BTU: 65,000
- » Suggested Fire Glass: 75 lbs.
- » Material: GFRC Concrete
- » Finish: Smooth Finish Concrete
- » Items Included: Fire Pan, Burner, Key Valve, Key, Hoses, Lava Rock
- » Propane Tank Storage: Yes



Carmen Fire Pit

OPT-CRM5616 Match Lit
OPT-CRM5616EKIT Electronic Ignition

- » Dimensions: 56" x 16"
- » Height: 16"
- » Burn Area: 38" x 8" x 2"
- » Weight: 465 lbs.
- » BTU: 65,000
- » Suggested Fire Glass: 75 lbs.
- » Material: GFRC Concrete
- » Finish: Smooth Finish Concrete
- » Items Included: Fire Pan, Burner, Key Valve, Key, Hoses, Lava Rock
- » Propane Tank Storage: No

OPT-CRM5624 Match Lit
OPT-CRM5624EKIT Electronic Ignition

- » Dimensions: 56" x 16"
- » Height: 24"
- » Burn Area: 38" x 8" x 2"
- » Weight: 610 lbs.
- » BTU: 65,000
- » Suggested Fire Glass: 75 lbs.
- » Material: GFRC Concrete
- » Finish: Smooth Finish Concrete
- » Items Included: Fire Pan, Burner, Key Valve, Key, Hoses, Lava Rock
- » Propane Tank Storage: Yes

The Outdoor Plus individually handcrafts all of the products shown here. Finishes are subject to slight texture/color variations. Metallic Finishes and Rustic Finishes are available at an extra charge

When ordering, specify the concrete color by adding the color code to the end of the part number. **Example:** 24" Black Maya Water Bowl = OPT-24SWO-BLK

Black -BLK	Ash -ASH	Natural Gray -NGY	Gray -GRY	White Limestone -LIM	Chocolate -CHC	Chestnut -CST	Brown -BRN	Vanilla -VAN
Rustic Gray -RGR	Moss Stone -RMS	Rustic White -RWH	Coffee -RCF	Slate -MSL	Silver -MSV	Pearl -MPR	Bronze -MBR	Copper -MCP

RUSTIC COLLECTION

Cabo Square Fire Pit

OPT-CBSQ36 Match Lit
OPT-CBSQ36EKIT Electronic Ignition

- » Dimensions: 36" x 36"
- » Height: 16"
- » Base: 24" x 24"
- » Burn Area: 20" x 20" x 2"
- » Weight: 245 lbs.
- » BTU: 65,000
- » Suggested Fire Glass: 50 lbs.

OPT-CBSQ48 Match Lit
OPT-CBSQ48EKIT Electronic Ignition

- » Dimensions: 48" x 48"
- » Height: 16"
- » Base: 36" x 36"
- » Burn Area: 28" x 28" x 2"
- » Weight: 355 lbs.
- » BTU: 65,000
- » Suggested Fire Glass: 75 lbs.
- » Material: GFRC Concrete
- » Finish: Smooth Finish Concrete
- » Items Included: Fire Pan, Burner, Key Valve, Key, Hoses, Lava Rock
- » Propane Tank Storage: No



Boston Fire Pillar

With Access Door
OPT-BSTON20AD Match Lit
OPT-BSTON20ADEKIT Electronic Ignition

Without Access Door
OPT-BSTON20 Match Lit
OPT-BSTON20EKIT Electronic Ignition

- » Dimensions: 20" x 20"
- » Height: 33"
- » Base: 15" x 15"
- » Burn Area: 13" x 13" x 2"
- » Weight: 145 lbs.
- » BTU: 65,000
- » Suggested Fire Glass: 25 lbs.
- » Material: GFRC Concrete
- » Finish: Smooth Finish Concrete
- » Items Included: Fire Pan, Burner, Key Valve, Key, Hoses, Lava Rock
- » Propane Tank Storage: Yes



Castillo Fire Pillar

With Access Door
OPT-CSTO22AD Match Lit
OPT-CSTO22ADEKIT Electronic Ignition

Without Access Door
OPT-CSTO22 Match Lit
OPT-CSTO22EKIT Electronic Ignition

- » Diameter: 22"
- » Height: 33"
- » Base: 13"
- » Burn Area Diameter: 22"
- » Weight: 125 lbs.
- » BTU: 65,000
- » Suggested Fire Glass: 25 lbs.
- » Material: GFRC Concrete
- » Finish: Smooth Finish Concrete
- » Items Included: Fire Pan, Burner, Key Valve, Key, Hoses, Lava Rock
- » Propane Tank Storage: Yes



The Outdoor Plus individually handcrafts all of the products shown here. Finishes are subject to slight texture/color variations. Metallic Finishes and Rustic Finishes are available at an extra charge

When ordering, specify the concrete color by adding the color code to the end of the part number. Example: 24" Black Maya Water Bowl = OPT-24SWO-BLK

Black -BLK	Ash -ASH	Natural Gray -NGY	Gray -GRY	White Limestone -LIM	Chocolate -CHC	Chestnut -CST	Brown -BRN	Vanilla -VAN
Rustic Gray -RGR	Moss Stone -RMS	Rustic White -RWH	Coffee -RCF	Slate -MSL	Silver -MSV	Pearl -MPR	Bronze -MBR	Copper -MCP

Cabo Linear Fire Pit

OPT-CBLN56 Match Lit
OPT-CBLN56EKIT Electronic Ignition

- » Dimensions: 56" x 38"
- » Height: 16"
- » Base: 44" x 26"
- » Burn Area: 36" x 16" x 2"
- » Weight: 245 lbs.
- » BTU: 65,000
- » Suggested Fire Glass: 75 lbs.
- » Material: GFRC Concrete
- » Finish: Smooth Finish Concrete
- » Items Included: Fire Pan, Burner, Key Valve, Key, Hoses, Lava Rock
- » Propane Tank Storage: No

OPT-CBLN66 Match Lit
OPT-CBLN66EKIT Electronic Ignition

- » Dimensions: 66" x 38"
- » Height: 16"
- » Base: 54" x 26"
- » Burn Area: 36" x 16"
- » Weight: 290 lbs.
- » BTU: 65,000
- » Suggested Fire Glass: 75 lbs.

OPT-CBLN90 Match Lit
OPT-CBLN90EKIT Electronic Ignition

- » Dimensions: 90" x 38"
- » Height: 16"
- » Base: 78" x 26"
- » Burn Area: 66" x 16"
- » Weight: 395 lbs.
- » BTU: 65,000
- » Suggested Fire Glass: 125 lbs.



CUSTOM 9' STAINLESS STEEL HAY STACK SCULPTURE

TOPFIRES

BY THE OUTDOOR PLUS

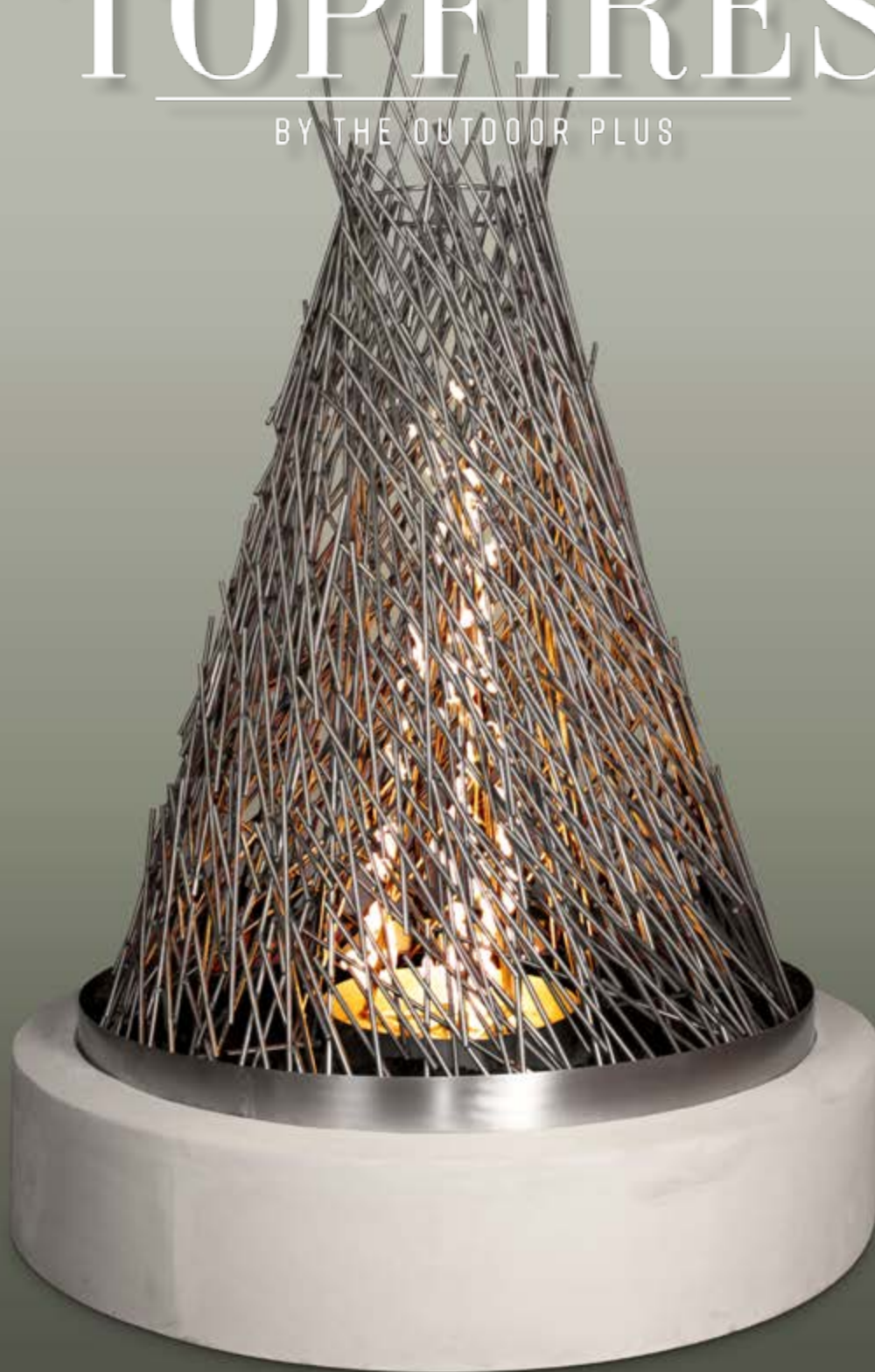

FOR MORE INFORMATION ABOUT CUSTOM UNITS, VISIT PAGE 112 OR SEND
AN INQUIRY ON OUR WEBSITE AT THEOUTDOORPLUS.COM/CUSTOM

FIRE PITS & FIRE TABLES



Merona Fire Table

TOP-MC4622 Match Lit
TOP-MC4622EKIT Electronic Ignition

- » Dimensions: 46" x 22"
- » Height: 24"
- » Burning Area: 30" x 8" x 2"
- » Weight: 195 Lbs.
- » BTU: 65,000
- » Suggested Fire Glass: 25 lbs.
- » Material: Steel / Stainless Steel
- » Finish: Black Powder Coat / Brushed Stainless Steel
- » Items Included: Fire Pan, 24" Linear Burner, Key Valve, Key, Hoses, Lava Rock
- » Propane Tank Storage: Yes

Eaves Stainless Steel Fire Pit

OPT-SLT60 Match Lit
OPT-SLT60EKIT Electronic Ignition

- » Dimensions: 60" x 10"
- » Height: 10"
- » Burning Area: 56" x 6" x 2"
- » Weight: 85 Lbs.
- » BTU: 65,000
- » Suggested Fire Glass: 50 lbs.
- » Material: Stainless Steel
- » Finish: Brushed Stainless Steel
- » Items Included: Fire Pan, 48" Linear Burner, Key Valve, Key, Hoses, Lava Rock
- » Propane Tank Storage: No



Eaves Powder Coated Fire Pit

OPT-LBT60 Match Lit
OPT-LBT60EKIT Electronic Ignition

- » Dimensions: 60" x 10"
- » Height: 10"
- » Burning Area: 56" x 6" x 2"
- » Weight: 85 Lbs.
- » BTU: 65,000
- » Suggested Fire Glass: 50 lbs.
- » Material: Steel
- » Finish: Powder coat
- » Items Included: Fire Pan, 48" Linear Burner, Key Valve, Key, Hoses, Lava Rock
- » Propane Tank Storage: No



Powder Coat Color Options

When ordering, specify the powder coat color by adding the color code to the end of the part number. (see swatches to the left)

Example: Gray Eaves Fire Pit = OPT-LBT60-GRY

The Outdoor Plus individually handcrafts all of the products shown here. Finishes are subject to slight texture/color variations.

FIRE PITS & FIRE TABLES

Cazo Stainless Steel Fire Pit - No Ledge



OPT-SS48FP Match Lit
OPT-SS48FPEKIT Electronic Ignition

- » Diameter: 48"
- » Height: 12"
- » Burning Area: 42"
- » Base Diameter: 24"
- » Weight: 155 Lbs.
- » BTU: 65,000
- » Suggested Fire Glass: 100 lbs.
- » Material: Stainless Steel
- » Finish: Brushed Stainless Steel
- » Items Included: Fire Pan, Burner, Key Valve, Key, Hoses, Lava Rock
- » Propane Tank Storage: No

Quad Copper Fire Pit

OPT-CPRSQ36 Match Lit
OPT-CPRSQ36EKIT Electronic Ignition

- » Dimensions: 36" x 36"
- » Height: 15"
- » Burning Area: 18" x 18" x 2"
- » Weight: 90 lbs.
- » BTU: 65,000
- » Suggested Fire Glass: 50 lbs.
- » Material: Copper
- » Finish: Hammered Patina Copper
- » Items Included: Fire Pan, Burner, Key Valve, Key, Hoses, Lava Rock
- » Propane Tank Storage: No

OPT-CPRSQ42 Match Lit
OPT-CPRSQ42EKIT Electronic Ignition

- » Dimensions: 42" x 42"
- » Height: 15"
- » Burning Area: 24" x 24" x 2"
- » Weight: 105 lbs.
- » BTU: 65,000
- » Suggested Fire Glass: 75 lbs.
- » Material: Copper
- » Finish: Hammered Patina Copper
- » Items Included: Fire Pan, Burner, Key Valve, Key, Hoses, Lava Rock
- » Propane Tank Storage: No



Cazo Copper Fire Pit - No Ledge



OPT-RHC48 Match Lit
OPT-RHC48EKIT Electronic Ignition

- » Diameter: 48"
- » Base Diameter: 18"
- » Height: 15"
- » Burning Area: 40"
- » Weight: 185 lbs.
- » BTU: 65,000
- » Suggested Fire Glass: 150 lbs.
- » Material: Copper
- » Finish: Patina Copper
- » Items Included: Fire Pan, Burner, Key Valve, Key, Hoses, Lava Rock
- » Propane Tank Storage: No

The Outdoor Plus individually handcrafts all of the products shown here. Finishes are subject to slight texture/color variations.

FIRE PITS & FIRE TABLES



Vista Copper Fire Pit

OPT-FPT2500 Match Lit
OPT-FPT2500EKIT Electronic Ignition

- » Dimensions: 24" x 24"
- » Base Dimensions: 16" x 16"
- » Height: 24"
- » Burning Area: 16" x 16" x 2"
- » Weight: 165 lbs.
- » BTU: 65,000
- » Suggested Fire Glass: 25 lbs.
- » Material: Copper
- » Finish: Patina Copper
- » Items Included: Fire Pan, Burner, Key Valve, Key, Hoses, Lava Rock
- » Propane Tank Storage: Yes

Martillo Copper Fire Pit

OPT-48RM Match Lit
OPT-48RMEKIT Electronic Ignition

- » Diameter: 48"
- » Height: 24"
- » Base Diameter: 30"
- » Burning Area: 24"
- » Weight: 105 lbs.
- » BTU: 65,000
- » Suggested Fire Glass: 50 lbs.
- » Material: Copper
- » Items Included: Fire Pan, Burner, Key Valve, Key, Hoses, Lava Rock
- » Propane Tank Storage: Yes



Cazo Copper Fire Pit

OPT-RS48 Match Lit
OPT-RS48EKIT Electronic Ignition

- » Diameter: 48"
- » Base Diameter: 18"
- » Height: 15"
- » Burning Area: 24"
- » Weight: 185 lbs.
- » BTU: 65,000
- » Suggested Fire Glass: 50 lbs.
- » Material: Copper
- » Finish: Patina Copper
- » Items Included: Fire Pan, Burner, Key Valve, Key, Hoses, Lava Rock
- » Propane Tank Storage: No



The Outdoor Plus individually handcrafts all of the products shown here. Finishes are subject to slight texture/color variations.

FIRE PITS & FIRE TABLES

Amere Fire Pit



OPT-SQ36CPM-HAMC Match Lit
OPT-SQ36CPMEKIT-HAMC Electronic Ignition

- » Dimensions: 36" x 36"
- » Height: 24"
- » Base: 30" x 30"
- » Burning Area: 20" x 20" x 2"
- » Weight: 120 lbs.
- » BTU: 65,000
- » Suggested Fire Glass: 50 lbs.
- » Material: Copper
- » Finish: Hammered Copper
- » Items Included: Fire pan, burner, key valve, key, hoses, lava rock.
- » Propane Tank Storage: Yes

OPT-SQ48CPM-HAMC Match Lit
OPT-SQ48CPMEKIT-HAMC Electronic Ignition

- » Dimensions: 48" x 48"
- » Height: 24"
- » Base: 36" x 36"
- » Burning Area: 24" x 24" x 2"
- » Weight: 155 lbs.
- » BTU: 65,000
- » Suggested Fire Glass: 75 lbs.
- » Material: Copper
- » Finish: Hammered Copper
- » Items Included: Fire pan, burner, key valve, key, hoses, lava rock.
- » Propane Tank Storage: Yes



A.



B.



C.



D.

Mesa Collection

A. **OPT-CPRTT4824** Hammered Copper
 B. **OPT-CSTT4824** Corten Steel
 C. **OPT-SSTT4824** Stainless Steel
 D. **OPT-PCTT4824** Powder-coat Steel

- » Dimensions: 48" x 24"
- » Height: 24"
- » Base: 36" x 18"
- » Burning Area: 36" x 12" x 2"
- » Weight: 120 lbs.
- » BTU: 45,000
- » Suggested Fire Glass: 50 lbs.
- » Items Included: Fire pan, burner, key valve, key, hoses, lava rock.
- » Propane Tank Storage: Yes

A. **OPT-CPRTT6024** Hammered Copper
 B. **OPT-CSTT6024** Corten Steel
 C. **OPT-SSTT6024** Stainless Steel
 D. **OPT-PCTT6024** Powder-coat Steel

- » Dimensions: 60" x 24"
- » Height: 24"
- » Base: 48" x 18"
- » Burning Area: 48" x 12" x 2"
- » Weight: 150 lbs.
- » BTU: 65,000
- » Suggested Fire Glass: 75 lbs.
- » Items Included: Fire pan, burner, key valve, key, hoses, lava rock.
- » Propane Tank Storage: Yes

A. **OPT-CPRTT7224** Hammered Copper
 B. **OPT-CSTT7224** Corten Steel
 C. **OPT-SSTT7224** Stainless Steel
 D. **OPT-PCTT7224** Powder-coat Steel

- » Dimensions: 72" x 24"
- » Height: 24"
- » Base: 60" x 18"
- » Burning Area: 60" x 12" x 2"
- » Weight: 180 lbs.
- » BTU: 80,000
- » Suggested Fire Glass: 75 lbs.
- » Items Included: Fire pan, burner, key valve, key, hoses, lava rock.
- » Propane Tank Storage: Yes

The Outdoor Plus individually handcrafts all of the products shown here. Finishes are subject to slight texture/color variations.

FIRE PITS & FIRE TABLES



A.



B.



D.



C.

Pismo Collection

- A. **OPT-CPRT4824** Hammered Copper
- B. **OPT-R4824CS** Corten Steel
- C. **OPT-R4824SS** Stainless Steel
- D. **OPT-R4824PCR** Powder-coat Steel

- » Dimensions: 48" x 24"
- » Height: 24"
- » Burning Area: 36" x 12" x 2"
- » Weight: 135 lbs.
- » BTU: 65,000
- » Suggested Fire Glass: 50 lbs.
- » Items Included: Fire pan, burner, key valve, key, hoses, lava rock.
- » Propane Tank Storage: Yes

- A. **OPT-CPRT6024** Hammered Copper
- B. **OPT-R6024CS** Corten Steel
- C. **OPT-R6024SS** Stainless Steel
- D. **OPT-R6024PCR** Powder-coat Steel

- » Dimensions: 60" x 24"
- » Height: 24"
- » Burning Area: 48" x 12" x 2"
- » Weight: 180 lbs.
- » BTU: 65,000
- » Suggested Fire Glass: 75 lbs.
- » Items Included: Fire pan, burner, key valve, key, hoses, lava rock.
- » Propane Tank Storage: Yes

- A. **OPT-CPRT7224** Hammered Copper
- B. **OPT-R7224CS** Corten Steel
- C. **OPT-R7224SS** Stainless Steel
- D. **OPT-R7224PCR** Powder-coat Steel

- » Dimensions: 72" x 24"
- » Height: 24"
- » Burning Area: 60" x 12" x 2"
- » Weight: 215 lbs.
- » BTU: 80,000
- » Suggested Fire Glass: 75 lbs.
- » Items Included: Fire pan, burner, key valve, key, hoses, lava rock.
- » Propane Tank Storage: Yes

- A. **OPT-CPRT8424** Hammered Copper
- B. **OPT-R8424CS** Corten Steel
- C. **OPT-R8424SS** Stainless Steel
- D. **OPT-R8424PCR** Powder-coat Steel

- » Dimensions: 84" x 24"
- » Height: 24"
- » Burning Area: 72" x 12" x 2"
- » Weight: 260 lbs.
- » BTU: 100,000
- » Suggested Fire Glass: 100 lbs.
- » Items Included: Fire pan, burner, key valve, key, hoses, lava rock.
- » Propane Tank Storage: Yes

The Outdoor Plus individually handcrafts all of the products shown here. Finishes are subject to slight texture/color variations.



48" Pismo Fire Pit - Corten Steel Finish

FIRE PITS & FIRE TABLES

Coronado Collection



B.



C.



D.

- A. **OPT-CORCPR48** Hammered Copper
- B. **OPT-CORCS48** Corten Steel
- C. **OPT-CORSS48** Stainless Steel
- D. **OPT-CORPC48** Powder-coat Steel

- » Dimensions: 48" x 28"
- » Height: 15"
- » Burning Area: 30" x 10" x 2"
- » Weight: 175 lbs.
- » BTU: 45,000
- » Suggested Fire Glass: 50 lbs.

- A. **OPT-CORCPR60** Hammered Copper
- B. **OPT-CORCS60** Corten Steel
- C. **OPT-CORSS60** Stainless Steel
- D. **OPT-CORPC60** Powder-coat Steel

- » Dimensions: 60" x 28"
- » Height: 15"
- » Burning Area: 42" x 10" x 2"
- » Weight: 195 lbs.
- » BTU: 65,000
- » Suggested Fire Glass: 50 lbs.

- A. **OPT-CORCPR72** Hammered Copper
- B. **OPT-CORCS72** Corten Steel
- C. **OPT-CORSS72** Stainless Steel
- D. **OPT-CORPC72** Powder-coat Steel

- » Dimensions: 72" x 28"
- » Height: 15"
- » Burning Area: 54" x 10" x 2"
- » Weight: 220 lbs.
- » BTU: 80,000
- » Suggested Fire Glass: 75 lbs.

- A. **OPT-CORCPR84** Hammered Copper
- B. **OPT-CORCS84** Corten Steel
- C. **OPT-CORSS84** Stainless Steel
- D. **OPT-CORPC84** Powder-coat Steel

- » Dimensions: 84" x 28"
- » Height: 15"
- » Burning Area: 66" x 10" x 2"
- » Weight: 245 lbs.
- » BTU: 110,000
- » Suggested Fire Glass: 75 lbs.

- A. **OPT-CORCPR96** Hammered Copper
- B. **OPT-CORCS96** Corten Steel
- C. **OPT-CORSS96** Stainless Steel
- D. **OPT-CORPC96** Powder-coat Steel

- » Dimensions: 96" x 28"
- » Height: 15"
- » Burning Area: 78" x 10" x 2"
- » Weight: 270 lbs.
- » BTU: 135,000
- » Suggested Fire Glass: 100 lbs.

ALL FIRE PITS INCLUDE

- » Fire Pan, Burner, Key Valve, Key, Hoses, Lava Rock
- » Propane Tank Storage: No



Powder Coat Color Options

When ordering, specify the powder coat color by adding the color code to the end of the part number. (see swatches to the left)

Example: Black Coronado Fire Pit = OPT-CORPC48-BLK

The Outdoor Plus individually handcrafts all of the products shown here. Finishes are subject to slight texture/color variations.



72" Coronado - White Powder-coat Finish



48" Coronado - Black Powder-coat Finish

FIRE PITS & FIRE TABLES



Forma Collection



B.

- A. **OPT-3030SQCPR** Hammered Copper
- B. **OPT-3030SQCS** Corten Steel
- C. **OPT-3030SQSS** Stainless Steel
- D. **OPT-30PCSQ** Powder-coat Steel

- » Dimensions: 30" x 30"
- » Height: 24"
- » Burning Area: 18" x 18" x 2"
- » Weight: 70 lbs.
- » BTU: 65,000
- » Suggested Fire Glass: 25 lbs.

- A. **OPT-3636SQCPR** Hammered Copper
- B. **OPT-3636SQCS** Corten Steel
- C. **OPT-3636SQSS** Stainless Steel
- D. **OPT-36PCSQ** Powder-coat Steel

- » Dimensions: 36" x 36"
- » Height: 24"
- » Burning Area: 24" x 24" x 2"
- » Weight: 90 lbs.
- » BTU: 65,000
- » Suggested Fire Glass: 50 lbs.



C.

- A. **OPT-4242SQCPR** Hammered Copper
- B. **OPT-4242SQCS** Corten Steel
- C. **OPT-4242SQSS** Stainless Steel
- D. **OPT-42PCSQ** Powder-coat Steel

- » Dimensions: 42" x 42"
- » Height: 24"
- » Burning Area: 30" x 30" x 2"
- » Weight: 105 lbs.
- » BTU: 90,000
- » Suggested Fire Glass: 100 lbs.

- A. **OPT-4848SQCPR** Hammered Copper
- B. **OPT-4848SQCS** Corten Steel
- C. **OPT-4848SQSS** Stainless Steel
- D. **OPT-48PCSQ** Powder-coat Steel

- » Dimensions: 48" x 48"
- » Height: 24"
- » Burning Area: 36" x 36" x 2"
- » Weight: 155 lbs.
- » BTU: 90,000
- » Suggested Fire Glass: 125 lbs.



D.

- A. **OPT-6060SQCPR** Hammered Copper
- B. **OPT-6060SQCS** Corten Steel
- C. **OPT-6060SQSS** Stainless Steel
- D. **OPT-60PCSQ** Powder-coat Steel

- » Dimensions: 60" x 60"
- » Height: 24"
- » Burning Area: 48" x 48" x 2"
- » Weight: 215 lbs.
- » BTU: 90,000
- » Suggested Fire Glass: 225 lbs.

ALL FIRE PITS INCLUDE

- » Fire Pan, Burner, Key Valve, Key, Hoses, Lava Rock
- » Propane Tank Storage: No

The Outdoor Plus individually handcrafts all of the products shown here. Finishes are subject to slight texture/color variations.

Custom 48" Florence Fire Pit With Custom Black & White Tile Finish



For more information about custom units, go to page 70 or visit theoutdoorplus.com/custom

FIRE PITS & FIRE TABLES



30" Shown



42" Shown



30" Shown

Beverly Collection

- A. **OPT-30RRCP** Hammered Copper
- B. **OPT-30RRCS** Corten Steel
- C. **OPT-30RRSS** Stainless Steel
- D. **OPT-30PCB** Powder-coat Steel

- » Diameter: 30"
- » Height: 24"
- » Burning Area: 18"
- » Weight: 105 lbs.
- » BTU: 50,000
- » Suggested Fire Glass: 50 lbs.

ALL FIRE PITS INCLUDE

- » Fire Pan, Burner, Key Valve, Key, Hoses, Lava Rock
- » Propane Tank Storage: Yes

- A. **OPT-36RRCP** Hammered Copper
- B. **OPT-36RRCS** Corten Steel
- C. **OPT-36RRSS** Stainless Steel
- D. **OPT-36PCB** Powder-coat Steel

- » Diameter: 36"
- » Height: 24"
- » Burning Area: 24"
- » Weight: 150 lbs.
- » BTU: 75,000
- » Suggested Fire Glass: 50 lbs.

- A. **OPT-42RRCP** Hammered Copper
- B. **OPT-42RRCS** Corten Steel
- C. **OPT-42RRSS** Stainless Steel
- D. **OPT-42PCB** Powder-coat Steel

- » Diameter: 42"
- » Height: 24"
- » Burning Area: 30"
- » Weight: 185 lbs.
- » BTU: 90,000
- » Suggested Fire Glass: 75 lbs.



60" Shown



72" Shown



60" Copper Vein

Billow Collection

- A. **OPT-BLWSS60** Stainless Steel
- B. **OPT-BLWCS60** Corten Steel
- C. **OPT-BLWPC60** Powder-coat Steel

- » Dimensions: 60" x 24"
- » Height: 24"
- » Burning Area: 48" x 12" x 2"
- » Weight: 195 lbs.
- » BTU: 75,000
- » Suggested Fire Glass: 50 lbs.

ALL FIRE PITS INCLUDE

- » Fire Pan, Burner, Key Valve, Key, Hoses, Lava Rock
- » Propane Tank Storage: Yes

- A. **OPT-BLWSS72** Stainless Steel
- B. **OPT-BLWCS72** Corten Steel
- C. **OPT-BLWPC72** Powder-coat Steel

- » Dimensions: 72" x 24"
- » Height: 24"
- » Burning Area: 60" x 12" x 2"
- » Weight: 230 lbs.
- » BTU: 90,000
- » Suggested Fire Glass: 75 lbs.

The Outdoor Plus individually handcrafts all of the products shown here. Finishes are subject to slight texture/color variations.

FIRE PITS & FIRE TABLES

Unity Fire Pit - 24" Tall

- OPT-UNYCP48** Hammered Copper
- OPT-RCRTN48** Corten Steel
- OPT-UNYSS48** Stainless Steel
- OPT-UNYPC48** Powder-coat Steel

- » Diameter: 48"
- » Height: 24"
- » Burning Area: 24"
- » Weight: 155 lbs.
- » BTU: 65,000
- » Suggested Fire Glass: 50 lbs.

ALL FIRE PITS INCLUDE

- » Fire Pan, Burner, Key Valve, Key, Hoses, Lava Rock
- » Propane Tank Storage: Yes

- OPT-UNYCP60** Hammered Copper
- OPT-RCRTN60** Corten Steel
- OPT-UNYSS60** Stainless Steel
- OPT-UNYPC60** Powder-coat Steel

- » Diameter: 60"
- » Height: 24"
- » Burning Area: 36"
- » Weight: 205 lbs.
- » BTU: 95,000
- » Suggested Fire Glass: 100 lbs.

- OPT-UNYCP72** Hammered Copper
- OPT-RCRTN72** Corten Steel
- OPT-UNYSS72** Stainless Steel
- OPT-UNTPC72** Powder-coat Steel

- » Diameter: 72"
- » Height: 24"
- » Burning Area: 48"
- » Weight: 270 lbs.
- » BTU: 175,000
- » Suggested Fire Glass: 200 lbs.

Unity Fire Pit - 18" Tall

- OPT-UNYCP4818** Hammered Copper
- OPT-RCRTN4818** Corten Steel
- OPT-UNYSS4818** Stainless Steel
- OPT-UNYPC4818** Powder-coat Steel

- » Diameter: 48"
- » Height: 18"
- » Burning Area: 24"
- » Weight: 140 lbs.
- » BTU: 65,000
- » Suggested Fire Glass: 50 lbs.

ALL FIRE PITS INCLUDE

- » Fire Pan, Burner, Key Valve, Key, Hoses, Lava Rock
- » Propane Tank Storage: No

- OPT-UNYCP6018** Hammered Copper
- OPT-RCRTN6018** Corten Steel
- OPT-UNYSS6018** Stainless Steel
- OPT-UNYPC6018** Powder-coat Steel

- » Diameter: 60"
- » Height: 18"
- » Burning Area: 36"
- » Weight: 185 lbs.
- » BTU: 95,000
- » Suggested Fire Glass: 100 lbs.

- OPT-UNYCP7218** Hammered Copper
- OPT-RCRTN7218** Corten Steel
- OPT-UNYSS7218** Stainless Steel
- OPT-UNYPC7218** Powder-coat Steel

- » Diameter: 72"
- » Height: 18"
- » Burning Area: 48"
- » Weight: 245 lbs.
- » BTU: 175,000
- » Suggested Fire Glass: 200 lbs.



72" Unity Fire Pit - 24" Height
OPT-RCRTN72



72" Unity Shown - 18" Height
OPT-UNYPC7218

FIRE PIT ADD-ONS



Electronic Ignition Kit Install

Add **"-EKIT"** To The End Of The Fire Pit SKU

- » Electronic Ignition Kit Installed Onto Any Fire Pit Of Your Choice
- » Add-on ONLY
- » Includes the cost of the components and installation.
- » **Includes:** Electronic Valve (12VAC), 12VAC Pilot Igniter, Transformer.



Key Valve Install (Bowls Only)

Add **"-KVI"** To The End Of The Fire Pit SKU

- » Key Valve installed onto the side of a bowl
- » Add-on ONLY, cannot be bought separately.
- » No Assembly Required
- » No need to add onto fire pits as all fire pits come with a key valve
- » **Includes:** Key Valve, Key Valve Bracket, Key, Stainless Steel Gas Hose (2x)



Dial Timer Panel

Add **"-DTMP"** To The End Of The Fire Pit SKU

- » Stainless Steel panel installed onto any fire pit of your choice.
- » No Assembly Required
- » Add-on ONLY, cannot be bought separately.
- » **NOT Compatible With Match Lit Units**
- » Fire Pit MUST Have Electronic Ignition
- » **Includes:** Dial Timer (110V), Key Valve, Key, Stainless Steel Gas Lines, Panel



Push Button Spark Ignition Panel

Add **"-PBSIP"** To The End Of The Fire Pit SKU

- » Stainless Steel panel installed onto the side of any fire pit of your choice.
- » No Assembly Required
- » Add-on ONLY, cannot be bought separately.
- » Battery Powered
- » **Includes:** Stainless Steel Panel, Key Valve, Key, Push Button Igniter, Electrode, Stainless Steel Gas Lines



Push Button Ignition With Flame Sense

Add **"-FSPAN"** To The End Of The Fire Pit SKU

- » Stainless Steel panel installed onto the side of any fire pit of your choice.
- » No Assembly Required
- » Add-on ONLY, cannot be bought separately.
- » Battery Powered
- » **Includes:** Flame Sense Control Panel, Electrode, Stainless Steel Gas Lines

SMART WEATHER ELECTRONIC IGNITION SYSTEM



Mini Capacity System

TOP-500EIS-100-12

- » Maximum Gas Output: 190K BTU/hr
- » Inlet Gas Pressure Limit: ½ PSI
- » Inlet / Outlet Size: ½" FIP
- » Electrical Rating: 12VAC
- » Hot Surface Igniter (HSI)
- » Thermocouple Flame Sensor
- » LED Diagnostics
- » -20° - 175° Temp Range
- » **Includes:** Electronic Valve, Pilot Igniter, 12VAC Transformer, Installation Manual



Standard Capacity System

TOP-500EIS-200-12

- » Maximum Gas Output: 290K BTU/hr
- » Inlet Gas Pressure Limit: ½ PSI
- » Inlet / Outlet Size: ½" FIP
- » Electrical Rating: 12VAC
- » Hot Surface Igniter (HSI)
- » Thermocouple Flame Sensor
- » LED Diagnostics
- » -20° - 175° Temp Range
- » **Includes:** Electronic Valve, Pilot Igniter, 12VAC Transformer, Installation Manual



High Capacity System

TOP-500EIS-300-12

- » Maximum Gas Output: 510K BTU/hr
- » Inlet Gas Pressure Limit: ½ PSI
- » Inlet / Outlet Size: ¾" FIP
- » Electrical Rating: 12VAC
- » Hot Surface Igniter (HSI)
- » Thermocouple Flame Sensor
- » LED Diagnostics
- » -20° - 175° Temp Range
- » **Includes:** Electronic Valve, Pilot Igniter, 12VAC Transformer, Installation Manual



Plug & Play Smart Weather Electronic Ignition System

These systems are ready for plug & play application. All you need to do is plug it into any 110V Three Prong Outlet. Do not use in applications within 10ft of a body of water such as a pool, fountain, pond or spa. Integrated Transformer



Mini Capacity System

TOP-500EIS-100-110

- » Max Gas Output: 190K BTU/hr
- » Max Inlet Gas Pressure: ½ PSI
- » Inlet / Outlet Size: ½" FIP
- » Electrical Rating: 110VAC
- » Hot Surface Igniter (HSI)
- » Thermocouple Flame Sensor
- » LED Diagnostics
- » -20° - 175° Temp Range
- » Integrated Transformer
- » 110V 3-prong Plug
- » **Includes:** Electronic Valve, Pilot Igniter & Installation Manual

Standard Capacity System

TOP-500EIS-200-110

- » Max Gas Output: 290K BTU/hr
- » Max Inlet Gas Pressure: ½ PSI
- » Inlet / Outlet Size: ½" FIP
- » Electrical Rating: 110VAC
- » Hot Surface Igniter (HSI)
- » Thermocouple Flame Sensor
- » LED Diagnostics
- » -20° - 175° Temp Range
- » Integrated Transformer
- » 110V 3-prong Plug
- » **Includes:** Electronic Valve, Pilot Igniter & Installation Manual

High Capacity System

TOP-500EIS-300-110

- » Max Gas Output: 510K BTU/hr
- » Max Inlet Gas Pressure: ½ PSI
- » Inlet / Outlet Size: ¾" FIP
- » Electrical Rating: 110VAC
- » Hot Surface Igniter (HSI)
- » Thermocouple Flame Sensor
- » LED Diagnostics
- » -20° - 175° Temp Range
- » Integrated Transformer
- » 110V 3-prong Plug
- » **Includes:** Electronic Valve, Pilot Igniter & Installation Manual



Pilot Igniter

TOP-500PI

- » Length: 19"
- » Stainless Steel / Brass Construction
- » Hot Surface Igniter (HSI)
- » Thermocouple Flame Sensor
- » Heat/Weather Resistant Sleeve



12V Control Panel

TOP-12VCP

- » 300 Watt
- » Input Voltage: 110/120 VAC
- » Output Voltage: 12/13/14VAC
- » Suitable for Swimming Pools, Spas & Fountains
- » Removable Mounting Brackets
- » Total of 10 Knock Out Locations



Bluetooth SWEIS Adapter

TOP-500BLU

- » Provides you with Bluetooth control for 12V Electronic Ignition Systems ONLY.
- » Supports iOS and Android
- » Free Smart Phone app available

ACCESSORIES



Emergency Stop Button

OPT-ESTOP

- » Outdoor Rated Electrical Box And Cover
- » 2x Cable Entries (1/2")
- » Suited For 110V Only
- » **Not Compatible With Match Lit Systems**



Remote Control System

OPT-400-XREMOTE

- » Outdoor Rated Box
- » Suited for 110V - 12V ONLY
- » Includes Remote, Receiver, Transformer & On/Off Switch
- » **Not Compatible With Match Lit Systems**

Wireless Remote Replacement

OPT-XRM



Electrical Dial Timer

OPT-DTM

- » 1-Hour Timer
- » Outdoor Rated Electrical Box And Cover
- » Suited For 110V Only
- » **Not Compatible With Match Lit Systems**



Emergency Stop Button with Key

OPT-ESTOPKEY

- » Outdoor Rated
- » 2X Cable Entrys (1/2")
- » Includes Two Keys
- » Suited For 110V Only
- » **Not Compatible With Match Lit Systems**



Emergency Stop Button & 1-hour Timer

OPT-ESTOPTM

- » Outdoor Rated
- » 4X Gas Entrys (1/2")



Installation Bracket

OPT-INBR

- » 100% Stainless Steel
- » For mounting of any bowl
- » Provides proper ventilation



1 Hour Gas Timer

OPT-TO

- » Includes: Timer and (2) nipples
- » 1/2" Female Inlets
- » Max BTU: 100,000
- » Max Temp: 125°



1 Hour Gas Timer & Mounting Plate

OPT-TP

- » Includes: (2) M to F 90° elbows
- » 1/2" Female Inlets
- » Max BTU: 100,000
- » Max Temp: 125°



1 Hour Gas Timer & Lock Box

OPT-TBL

- » Includes: (2) M to F 90° elbows
- » 1/2" Female Inlets
- » Max BTU: 100,000
- » Max Temp: 125°
- » Key and Lock Box

BURN MEDIA SELECTION

The Outdoor Plus' selection of burning media is perfect for any fire pit, fire bowl or fireplace. All glass comes in 25lb bags. Lava chunks come in 1 cubic foot quantities and polished lava comes in 1/2 cubic foot quantities. All options are suitable for any type of fire. We suggest covering the burner a maximum of 1 inch,

Note: using media that is not fire rated can be hazardous. Using media that is not sufficiently porous may retain moisture. This moisture can expand with heat and pieces can pop and be hazardous. Fire media is not intended for units used for cooking or grilling.



Black 1/2"-3/4"
OPT-701



Turquoise 1/2"-3/4"
OPT-706



Blue 1/2"-3/4"
OPT-702



Amber 1/2"-3/4"
OPT-708



Lava Chunks - 1"
OPT-150-50



1/4" Black Reflective
OPT-144BL

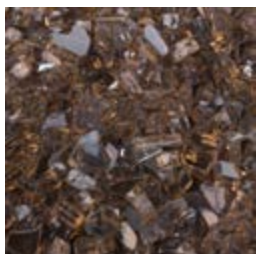

1/4" Copper Reflective
OPT-138C



1/4" Gold Reflective
OPT-144GL



1/4" Cobalt Reflective
OPT-144CB



Polished Lava 2"-3"
OPT-PL-50

How Much Glass Do I Need?

Use this table to decide how much glass you will need for your fire feature. These amounts are for units with a burning area depth of 2".

ROUND - 2" DEEP

Diameter	Amount
13"	15 lbs.
19"	30 lbs.
25"	50 lbs.
31"	80 lbs.
37"	125 lbs.
43"	160 lbs.

SQUARE - 2" DEEP

Size	Amount
16.5"	15 lbs.
18"	30 lbs.
24"	50 lbs.
30"	80 lbs.
36"	125 lbs.
48"	160 lbs.

RECTANGULAR - 2" DEEP		
Length	Width	Amount
24"	6"	17 lbs.
30"	6"	21 lbs.
36"	6"	25 lbs.
42"	6"	29 lbs.
48"	6"	34 lbs.
60"	6"	42 lbs.
72"	6"	50 lbs.
84"	6"	59 lbs.
96"	6"	67 lbs.
24"	12"	34 lbs.
30"	12"	42 lbs.
36"	12"	50 lbs.
42"	12"	58 lbs.
48"	12"	68 lbs.
60"	12"	84 lbs.
72"	12"	100 lbs.
84"	12"	118 lbs.
96"	12"	134 lbs.
24"	18"	50 lbs.
30"	18"	63 lbs.
36"	18"	76 lbs.
42"	18"	88 lbs.
48"	18"	100 lbs.
60"	18"	126 lbs.
72"	18"	151 lbs.
84"	18"	177 lbs.
96"	18"	200 lbs.



FLAME GUARDS & COVERS

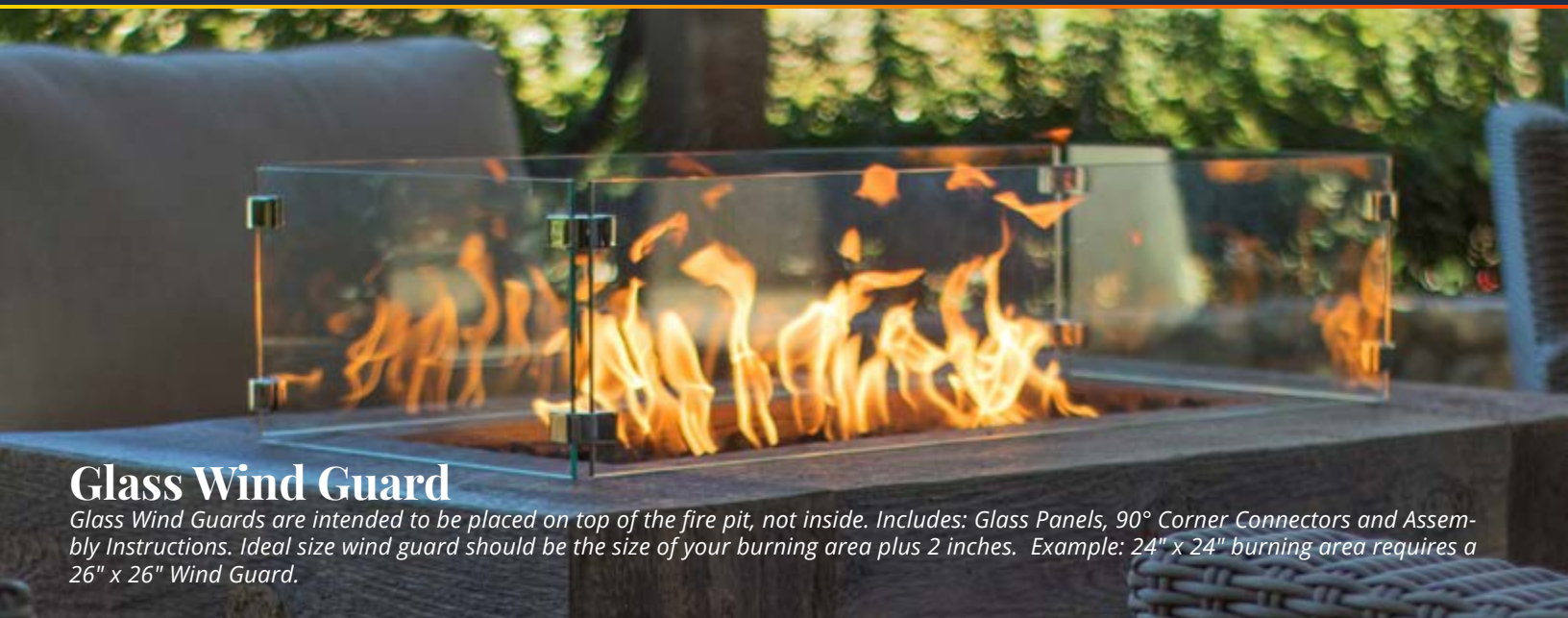

Glass Wind Guard

Glass Wind Guards are intended to be placed on top of the fire pit, not inside. Includes: Glass Panels, 90° Corner Connectors and Assembly Instructions. Ideal size wind guard should be the size of your burning area plus 2 inches. Example: 24" x 24" burning area requires a 26" x 26" Wind Guard.

Rectangular Glass Wind Guard

BURN AREA →	WIND GUARD SIZE	SKU	HEIGHT
24" x 8"	26" x 10" x 6"	OPT-WG-2610	6"
30" x 10"	32" x 12" x 6"	OPT-WG-3212	6"
31" x 11"	33" x 13" x 6"	OPT-WG-3313	6"
36" x 12"	38" x 14" x 6"	OPT-WG-3814	6"
42" x 10"	44" x 12" x 6"	OPT-WG-4412	6"
48" x 12"	50" x 14" x 6"	OPT-WG-5014	6"
54" x 10"	56" x 12" x 6"	OPT-WG-5612	6"
60" x 12"	62" x 14" x 6"	OPT-WG-6214	6"
66" x 10"	68" x 12" x 6"	OPT-WG-6812	6"
72" x 10"	80" x 12" x 6"	OPT-WG-8012	6"
84" x 10"	86" x 12" x 6"	OPT-WG8612	6"

Square Glass Wind Guard

BURN AREA →	WIND GUARD SIZE	SKU	HEIGHT
12" x 12"	14" x 14" x 6"	OPT-WG-1414	6"
20" x 20"	22" x 22" x 6"	OPT-WG-2222	6"
24" x 24"	26" x 26" x 6"	OPT-WG-2626	6"
28" x 28"	30" x 30" x 6"	OPT-WG-3030	6"
30" x 30"	32" x 32" x 6"	OPT-WG-3232	6"
38" x 38"	38" x 38" x 6"	OPT-WG-3838	6"
48" x 48"	50" x 50" x 6"	OPT-WG-5050	6"

Round Glass Wind Guard

BURN AREA →	WIND GUARD SIZE	SKU	HEIGHT
18"-22"	23" Round	OPT-WG-23	6"
23"-29"	30" Round	OPT-WG-30	6"
30"-37"	38" Round	OPT-WG-38	6"
38"-47"	48" Round	OPT-WG-48	6"



FLAME GUARDS & COVERS

Canvas Cover

Make sure your fire pit is protected from the elements by acquiring a durable and long-lasting canvas cover.

These covers are tougher and more resistant than traditional department store canvas covers

Includes: Canvas Cover with pull cord for a secure fit

Square Fire Pit Covers

SIZE	SKU
24" x 24"	OPT-CVR-2448
30" x 30"	OPT-CVR-3030
36" x 36"	OPT-CVR-3636
42" x 42"	OPT-CVR-4242
48" x 48"	OPT-CVR-4848
50" x 50"	OPT-CVR-5050

Round Fire Pit Covers

SIZE	SKU
30" Round	OPT-CVR-30R
36" Round	OPT-CVR-36R
38" Round	OPT-CVR-38R
42" Round	OPT-CVR-42R
48" Round	OPT-CVR-48R
54" Round	OPT-CVR-54R
60" Round	OPT-CVR-60R
72" Round	OPT-CVR-72R

Rectangular Fire Pit Covers

SIZE	SKU
60" x 10"	OPT-CVR-6010
46" x 22"	OPT-CVR-4622
48" x 24"	OPT-CVR-4824
54" x 24"	OPT-CVR-5424
60" x 24"	OPT-CVR-6024
72" x 24"	OPT-CVR-7224
84" x 24"	OPT-CVR-8424
48" x 28"	OPT-CVR-4828
60" x 28"	OPT-CVR-6028
72" x 28"	OPT-CVR-7228
84" x 28"	OPT-CVR-8428
96" x 28"	OPT-CVR-9628

Bowl Covers

SIZE	SKU
24" Round	OPT-BCVR-24R
27" Round	OPT-BCVR-27R
30" Round	OPT-BCVR-30R
31" Round	OPT-BCVR-31R
33" Round	OPT-BCVR-33R
36" Round	OPT-BCVR-36R
24" Square	OPT-BCVR-2424
30" Square	OPT-BCVR-3030
36" Square	OPT-BCVR-3636
48" Square	OPT-BCVR-4848



Stainless Steel Flame Guard

Includes: Stainless Steel Flame Guard
The Stainless Steel Flame Guards are made to order.

Steel Flame Guard

Includes: Mild Steel Flame Guard
The Steel Flame Guards are made to order.



CUSTOM FIRE & WATER FEATURES

The Outdoor Plus prides itself in manufacturing everything you see here. With a fully operational manufacturing facility, we are able to custom make practically any fire pit, fire tower, scuppers, pans, burners and more. Whether its a fire pit that needs a few inches adjusted or a completely original product, the possibilities are endless. Our experienced staff and array of machinery can manufacture what you truly desire.

To inquire, send an email to sales@theoutdoorplus.com or go to theoutdoorplus.com/custom

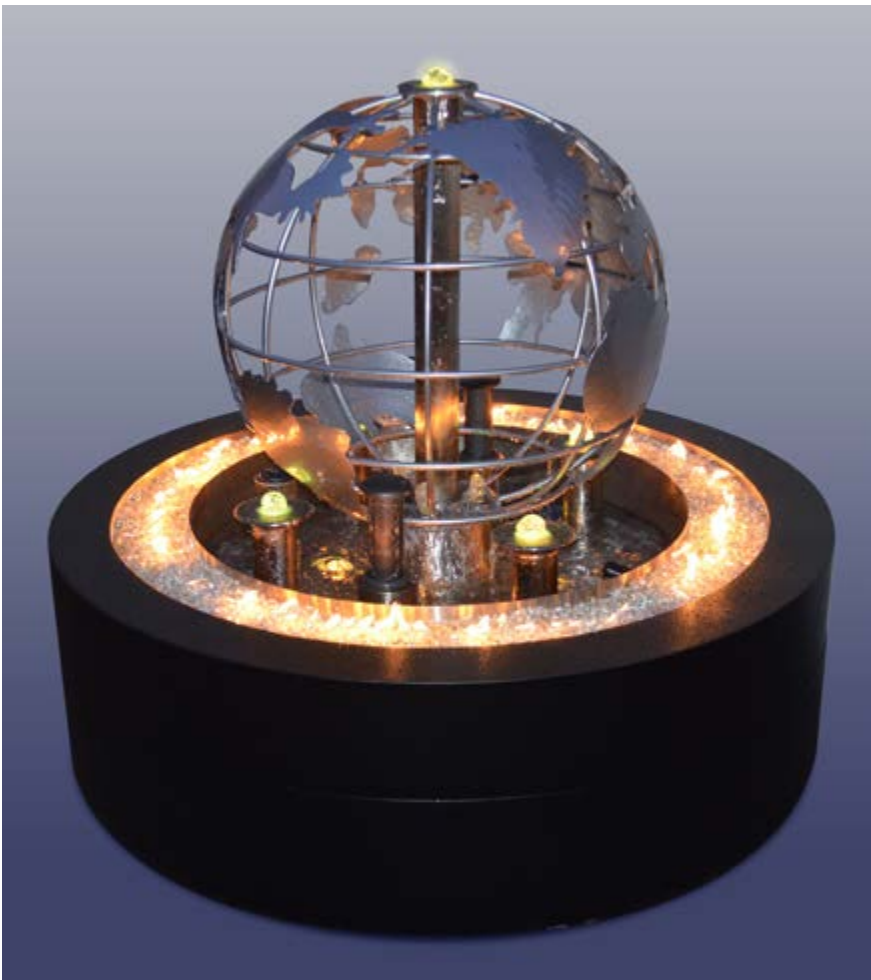

CUSTOM FIRE & WATER FEATURES



GAS AND ELECTRICAL LINE DIAGRAMS

These diagrams shown are for informational purposes only.

It is required that the proper installation manuals should be read prior to installing the unit.

Installations of all of fire & water units should be performed by a licensed professional.

Gas and Electrical lines shown are the same on fire pits & fire tables

Hoses, valves and gas kits shown are sold separately.

KEY VALVES RECOMMENDED IN ALL APPLICATIONS

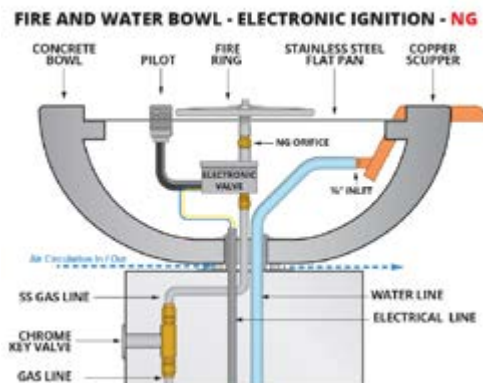
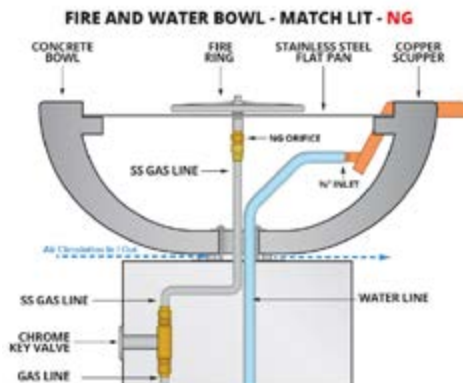
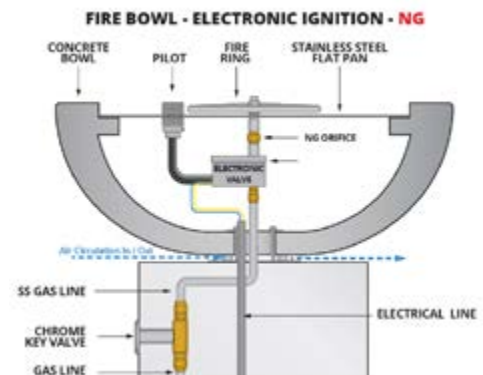
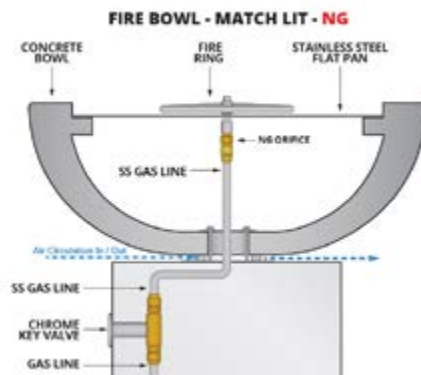
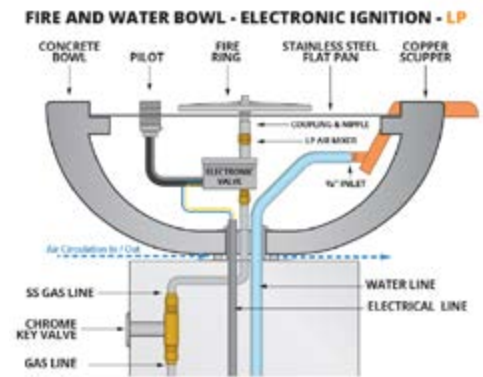
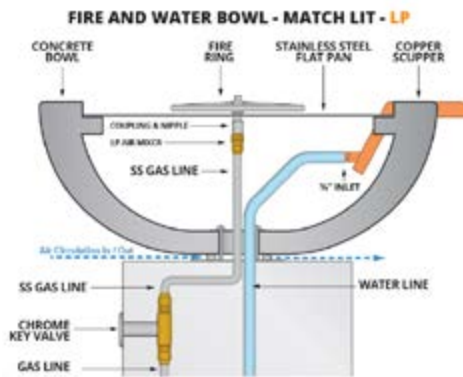
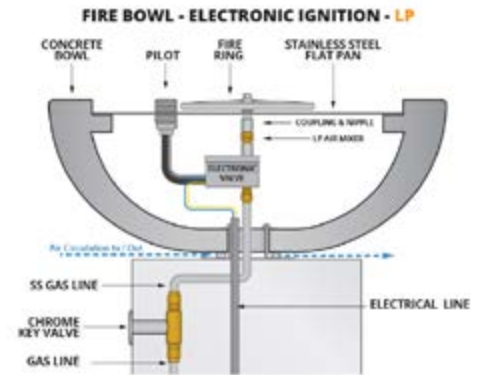
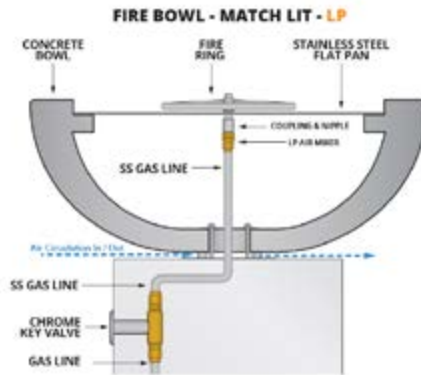

Clearance From Combustibles.

This diagram applies to all fire pits and fire features

Flooring

All fire pits and fire features must be installed on non-combustible flooring. If the fire feature is installed on a combustible floor, such as wood decking, a non-combustible floor paneling **MUST** be properly installed underneath.

Installation

We suggest that our products be installed by professionals that are locally licensed by the authority having jurisdiction in gas piping.

Service

We suggest that our products be serviced by a professional certified in the US by the National Fireplace Institute (NFI) as NFI Gas Specialists

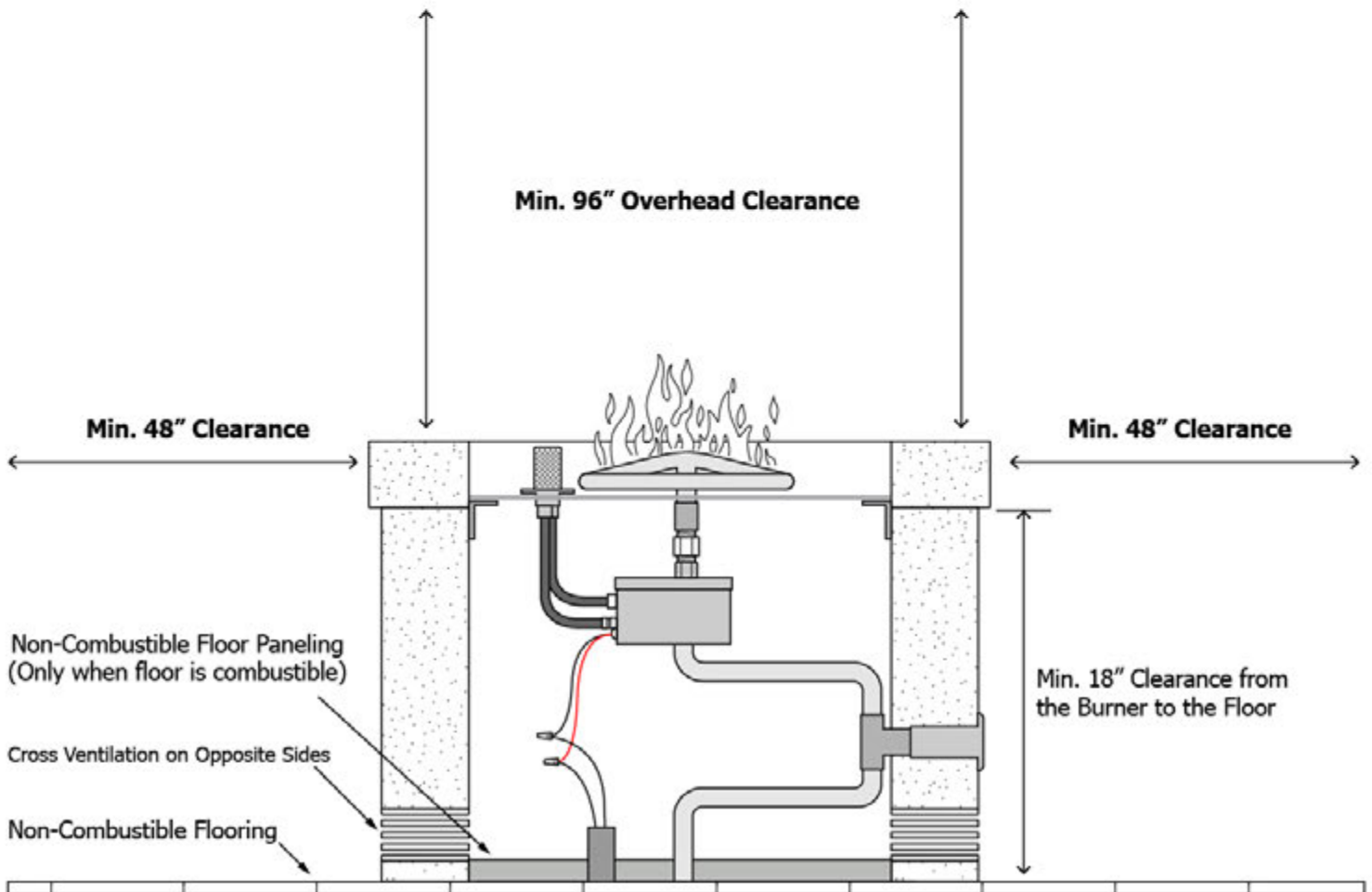

WARRANTY AND RETURN POLICY

LIMITED WARRANTY

The Outdoor Plus Company (TOP) warranties fire pits against manufacturing defects that prevent safe and correct function as follows:

- Electronics, Gas Valves, & Pilot Assembly: 1 year
- Stainless steel Burners & Brass Burners: Lifetime Warranty
- Stainless Steel Pan, & Valve Box: Commercial - 1 year; Residential - 3 years

This commences from the date of original sale / shipment from The Outdoor Plus. This warranty is for the parts and in-house (TOP) labor. The defective product must be sent back to TOP with a Return Merchandise Authorization (RMA) issued by TOP for that specific product and any other additional information for the nature of the defect or warrant claim the warranty does not cover items that have been damaged by overheating, modification, abuse, or improper storage.

Any labor involving installation or maintenance with the unit is not covered. This warranty excludes claims for consequential, indirect-collateral expenses arising from the products defects or warranty recovery. This warranty is only applied to original purchases.

PRODUCT RETURN POLICY

No returns on made-to-order goods.

No returns on custom features, NO EXCEPTIONS.

If a product is delivered incorrectly, it is the recipient's responsibility to notify TOP within 48 hours. TOP is not responsible for incorrect or damaged packages and shipments 48 hours after they have been received.

PRODUCT TESTING PROGRAM

If you believe a unit or component you received is defective, The Outdoor Plus will gladly test any component at our facility. TOP will cover shipping back to you.

DEFECTIVE: If an item is found to be defective it will be repaired or replaced at our discretion. TOP will absorb all costs of outgoing freight and replacement or repair costs if product is in warranty.

NON-DEFECTIVE: If the product is found to be non-defective it will be returned to the customer - no credit will be given. Freight coming in are at the customer's expense.

TOP ERROR: If a return is needed due to a mistake on our part, we will issue a RMA and Return Services Label. When products are received at TOP, credit will be issued for the products and the outgoing freight on the original invoice.

CUSTOMER ERROR: If an RMA is asked for and covers current new products in the original package, we will authorize the return. The customer is responsible for the return shipping. When products are received we will issue credit for the original customer cost less a 25% restocking charge.

Custom orders do not apply.

PRODUCT WARRANTY

The Outdoor Plus, Inc., warranties product against manufacturing defects that prevent safe and correct operation of the product commencing from the date of original sale or shipment from TOP. The warranty on parts and in-house labor will apply only to claims presented to us by our original customer and is in lieu of all other warranties expressed or implied. Please refer to the Warranty Chart below for warranty periods.

The defective product must be shipped back with an RMA (Return Merchandise Authorization) issued by TOP for that specific product which states the nature of the defect or warranty claim. Product to be returned should be packed carefully- The Outdoor Plus is not responsible for shipping damage on returned items. The original purchase information will be required. RMA's are only valid for 30 days from the date of issue by TOP and will not be processed if received after the expiration date. The RMA number must be indicated on the outside of the return package and a copy of the RMA should be placed in the package with product.

Our warranty does not cover items that have been damaged by overheating, modification, abuse, improper storage, installation, or maintenance. This warranty excludes claims for incidental or consequential damage and indirect collateral expenses arising from product defects or warranty recovery. Product manufactured by TOP including cLCus Certified models, cannot be altered or modified in any way.

The Outdoor Plus is not responsible for local codes and will not accept a return on any product that is not approved for installation. Please check with your local authorities or governing agencies for proper approvals before purchasing. TOP is not responsible for the actions including negligence of the installer.

FREIGHT POLICY

Most orders will be shipped FOB Ontario, California, with a standard shipping carrier selected by TOP unless customer specifically requests their own carrier and account. A freight quote may be requested in advance. TOP works diligently with standard carriers to achieve the best discounts available.

MINIMUM ADVERTISED PRICING POLICY

The Outdoor Plus Inc. unilaterally applies this Minimum Advertised Pricing Policy. This Policy is subject to change at any time by the Company at its sole discretion.

1. **PURPOSE:** The purpose of this policy is to protect the value of the Company's trademarks and brand names and to attract and retain reputable, customer-friendly vendors, brick & mortar and online.

2. **SCOPE:** This Policy is applicable to all sellers of the Company's products who advertise or sell Products on any Internet platform and to distributors that sell to such resellers. This Policy applies to all products of TOP

MINIMUM ADVERTISED PRICING POLICY

unless otherwise specified by TOP. The Policy applies only to prices advertised anywhere on the Internet or by means of the Internet (including but not limited to websites, social media, direct e-mail advertising, and related materials that are accessible through the Internet platform by means of a hyperlink). The Policy does not apply to print advertising or in-store advertising for products to be sold at a physical store but does apply to all advertising for sales to be made over or by means of the Internet. This policy does not apply to the price at which the products are actually sold. Nothing in the Policy or other agreement with the Company will constitute an agreement on the price or price levels at which Resellers or Distributors actually sell any Product.

3. INTERNET MINIMUM ADVERTISED PRICE: The Internet advertised price of a Product means the net price advertised on the Internet after all discounts, rebates, gifts or promotional items. The Internet Minimum Advertised Price ("MAP") shall be set by the Company from time to time in its sole discretion and shall be communicated by the Company to the Resellers from time to time. If the Company makes the MAP available on a website accessible to the Reseller and informs Reseller of this, it is the responsibility of the Reseller to maintain current knowledge of the MAP.

4. POLICY ON INTERNET PRICE ADVERTISING: It is the policy of the Company that Resellers shall not advertise any Company Product on the Internet at prices below the MAP for that Product established by the Company. This policy is not violated by Reseller advertising a higher price. Also, this policy is not violated by communication by email or telephone to an individual customer in response to a telephone or email inquiry from the customer. Statements on a website such as "call for pricing" for a Product do not violate the Policy as long as a price for the Product is provided on the same website and that price is equal to or exceeds the MAP. Also, it is a violation of this Policy for the Reseller to characterize or disclose any pricing as the Internet minimum advertised price or that such minimum is based on the Company's policies. Resellers and Distributors have not agreed to this unilateral Policy and the Company is not seeking any such agreement. However, if a Reseller or a Distributor violates this Policy, the Company's policy is to take certain unilateral actions.

5. ACTIONS BY THE COMPANY: The Company has the right to sell Products to each Reseller or Distributor or to refrain or stop from doing in its discretion for any reason or for no reason. Under this Policy, if Reseller advertises Products on the Internet below the MAP or otherwise violates this Policy, the Company may cease selling or shipping Products to Reseller or its customers and/or cease taking orders from Reseller for a temporary or permanent period in the Company's discretion, which may take into account circumstances such as the number of violations or the repetition of violations. Also, if a Distributor sells Product to any Reseller that violates this Policy, the Distributor will be in violation of

the Policy and the Company may cease selling or shipping Products to that Distributor or its customers and/or cease taking orders from that Distributor for a temporary or permanent period in the Company's discretion, which may take into account circumstances such as the number of violations or the repetition of violations. The Company will take these actions unilaterally and will not seek or accept any agreement by a Reseller or a Distributor or any assurance of future compliance by that Reseller or Distributor.

6. CONTACT INFORMATION: Company sales personnel have no authority to modify or grant exceptions to this Policy. All questions or comments regarding this Policy should be directed to the policy administrator at sales@theoutdoorplus.com

THE OUTDOOR PLUS PHOTOGRAPHY PROGRAM

Here at The Outdoor Plus we are always looking for the best images and photography that represents our products and the lifestyle around it.

Finished an installation that uses our products that you are proud of? Send us your images! Most DSLR cameras or high end smart phones will work! (Samsung Galaxy S6 or newer. iPhone 6 or newer)

Images requirements: Must be larger than 1000 x 1000 pixels. Must be high resolution.

Not sure if your photos meet these requirements? Send them to us and our in house media adviser will advise you.

If your images are approved, you will receive \$100 - \$150 credit for any future purchases. Send Pictures with: Your name, company name, phone number, Purchase Order # or Sales Order # to SALES@THEOUTDOORPLUS.COM. Help us promote your work with our amazing products. We look forward to your submissions.

TOPFIRES

BY THE OUTDOOR PLUS

235 E. MAIN ST. ONTARIO, CA 91761
P: (909) 460-5579 F: (909) 460-5530
THEOUTDOORPLUS.COM