

BN-LINK®

PRODUCT# BNC-U3S

**6-Outlet 7-Day
Digital Timer Stake
W/6 Ft Cord**



ENERGY
SAVING

Please keep this handbook

Designed in California

Made in China

www.bn-link.com

PRODUCT VIEW

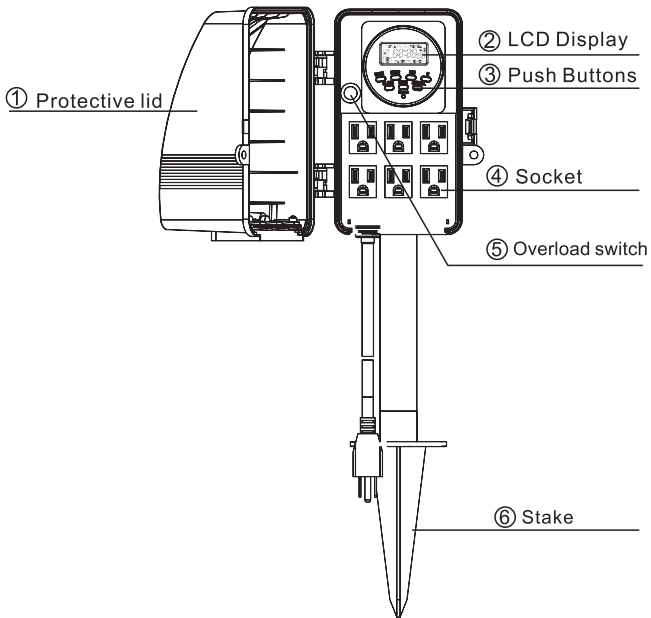

- ① **Protective Lid**
- ② **LCD Display:** Indicates current time and output state
- ③ **Push buttons**
- ④ **Socket:** Intended to be used with grounded devices only
- ⑤ **Overload switch:** Push to resume function in case an overload occurs
- ⑥ **Stake**

RATINGS

Rated Voltage: 125V, 60Hz

Max.Loading: 15A/1875W Resistive or General Purpose 1/2HP

Power Cord: 14/3 SJTW

WARNING

- Use a grounded outlet
- Follow local electrical codes
- For indoor/outdoor use
- Keep children away
- Unplug timer before cleaning
- Fully insert plug
- Do not exceed electrical ratings

Please make sure your product's protective lid is completely shut in order for the unit to be weather resistant. If the protective lid is slightly left open, water can enter the unit and damage the product.

APPLICATIONS

- Lighting
- Heating systems
- Humidifiers
- Nebulizers
- Cooling systems
- Indoor sprinklers
- Ventilators

A. INITIAL SETUP

1. Charge the internal battery

If the screen is blank, plug the timer into any outlet for 30 minutes to charge the internal battery.

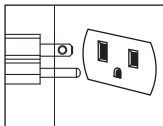

2. Reset the timer

Press the “RESET” button with the tip of a small non-metallic insulated tool, such as a pencil or toothpick. LCD display will turn on.

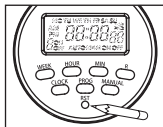

3. Unplug and program timer

With a charged battery, you can now set the timer up at the comfort of your chair.

B. SET UP CURRENT DAY & TIME

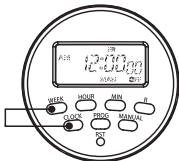

Fig 01

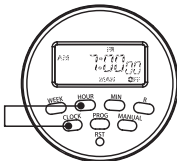

Fig 02

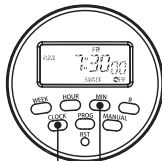

Fig 03

Example: if it is 7:30am Friday, please follow the below steps to set the current day and time.

1. While pressing and holding the **“CLOCK”** button, press the **“WEEK”** button until **“FR”** displays on top of the screen. (Fig 01)
2. While pressing and holding the **“CLOCK”** button, press the **“HOUR”** button until 7:00AM displays on the screen. (Fig 02)
3. While pressing and holding the **“CLOCK”** button, press the **“MIN”** button until 7:30AM displays on the screen. (Fig 03)

C. SET PROGRAM

Example: if you want to turn on a device everyday at 8:05 am and turn it off at 9:00pm, please follow below steps.

1. Press the **“PROG”** button to enter the program setting. (Fig 04)
You should see **“1ON”** at the bottom left of the LCD display. **“1ON”** means that this is the ON time for the 1st program.



Fig 04

2. Press the **“WEEK”** button multiple times until you get the day combination you want. (Fig 05)



Fig 05

Note: Press **“WEEK”** multiple times until you get the day combination you want.

Day combination options:

MO to SU

Individual day: MO, TU, WE, TH, FR, SA, SU

MO to FR
SA, SU
MO to SA
MO, WE, FR
TU, TH, SA
MO, TU, WE
TH, FR, SA

3. Press the “**HOUR**” button until 8:00 am displays on the screen. (Fig 06)



Fig 06

4. Press the “**MIN**” button until 8:05 am displays on the screen. (Fig 07)



Fig 07

5. Press the “**PROG**” button once to set the off time for the program. You should see "1OFF" at the bottom left of the LCD display. 1OFF means that this is the off time for the 1st program. (Fig 08)



Fig 08

6. Repeat steps 2 to 4 to set program “1 OFF”. (Fig 09)



Fig 09

7. If you want to set a second program, please press the “**PROG**” button again until you see 2ON, 2OFF (located on your bottom left corner of the screen). Here you can repeat steps 2 to 6 to set your second program.

Please pay attention to which program you are on and make sure you are entering the information on the correct on or off screen for that specific program. You can set multiple programs (1ON, 1OFF ...8ON, 8OFF). Ensure that there are no overlapping times.

To clear a program, press the “R” button. A cleared program will have 4 dashes “-- --”

To activate the program again, press the “R” button once more. It will bring back the previous schedule for that program.

8. Once you have set the programs, make sure you're in AUTO mode so that the timer will run your programs.

D. SWITCHING BETWEEN MANUAL/AUTO MODES OVERRIDING PROGRAMS/MANUAL TURN ON/OFF

To run your programs, your timer must be in AUTO mode. You can tell which mode the timer is currently in by checking if AUTO or MAN is present below the current time.

To switch between AUTO and MANUAL modes: Press and hold the “**MANUAL**” button for 4 seconds or more.

To switch between On and Off: press the "Manual" button

If the timer is on Auto mode, it will act as a timer and follow the scheduled programs.

If the timer is on Manual mode, it will act simply as an On/Off switch and will NOT follow any programs.

There are 4 modes available:

- Auto On: The timer will be powered on and will stay on until the next programmed off time.
- ☑ Auto Off: The timer will be powered off and will stay off until the next programmed on time.
- ☑ Manual On: The timer will bypass all programs and remain on indefinitely.
- ☑ Manual Off: The timer will bypass all programs and remain off indefinitely.

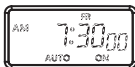
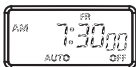
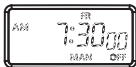

E. SET RANDOM FOR VACATION SECURITY

In order to use the random function, you must set at least 1 set of programs.

Pressing the “**WEEK**” and “**HOURL**” buttons simultaneously will activate security mode. “**RND**” will be shown to the right side of the display.

When the timer is working in Auto mode and the **random function** is on, the previously programmed ON and OFF times will be separately postponed by 2-32 minutes.

NOTE: A timer program shall be 33 minutes or longer for the random function work properly.

Press the “**WEEK**” and “**HOURL**” buttons again to turn off the random function.



Fig 10

F. DST - DAYLIGHT SAVING TIME FUNCTION

Press **HOURL** & **MIN** simultaneously to activate or deactivate **DST**

Note: A small symbol “+1h” will appear on the far right of the LCD screen when DST function is active.

Turning on this function will change the current time 1 hour ahead; turning off the function will revert the change.

This timer cannot adjust Daylight Saving Time by itself. It must be manually enabled.



(Fig 11) DST OFF



(Fig 12) DST ON



(Fig 13) DST ON

G. TROUBLESHOOTING

Timer does not turn on or off.

- Make sure **AM** and **PM** are correct on the current time and in the program settings.
- Timer program should be on **AUTO** setting.
- Make sure that both an **ON** and **Off** time has been specified
- If the numbers on the **LCD** display are not clear or blank on the screen, please plug the timer into any outlet for 30 minutes to charge the internal battery, then press the Reset button
- The 6 outlets work simultaneously and all follow the same programs. Outlets cannot be assigned individual programs.
- If the timer can not **Turn ON** or **Turn OFF** on time, please check if the Random function is active.
- If the timer is always **ON** or always **OFF**, please check if the program is in Auto mode.
- Please make sure to dig a hole into the ground where you would like to place the timer before installing the unit. Sticking the timer straight into packed dirt or soil can break the stake of the timer.

BN-LINK INC.

12991 Leffingwell Avenue, Santa Fe Springs
Customer Service Assistance: 1.909.592.1881

E-mail: support@bn-link.com

[Http://www.bn-link.com](http://www.bn-link.com)

Hours: 9AM - 5PM PST, Mon - Fri

Designed in California Made in China