



PRODUCT #
BND-60/SU101c

7-DAY IN-WALL DIGITAL TIMER



Please keep this handbook

BN-LINK INC.
12991 Leffingwell Avenue, Santa Fe Springs
Customer Service Assistance: 1.909.592.1881
E-mail: support@bn-link.com
Http://www.bn-link.com
Hours: 9AM - 5PM PST, Mon - Fri
Designed in California Made in China

TECHNICAL SPECIFICATIONS

18 ON/OFF per day
With ON/OFF/Timing shift function
With Ni-MH recharging battery
Min. Setting time: 1 minute
Max. Setting time: 7 days
Supply voltage: 125V~,60Hz
Contact rating: 15A/1875W Resistive
10A/1250W Tungsten, 10A/1250W Ballast, 1/2 HP, TV-5
Operating temperature: 5°F-122°F(-15°C-50°C)
Storage temperature: -4°F-140°F(-20°C-60°C)
Insulation class: II
Protection class: IP20
Important: inductive (starting load) should always be calculated especially when controlling lighting (because of variable inductive loads). If this load exceeds 8 Amps then it is imperative that a contactor be used.

PRODUCTS QUICK GUIDE

Features

- 1.The manual override button allows to turn on or off the timer at any time.
- 2.Easy-to read large LCD screen with clock display.
- 3.Up to 18 ON events and 18 OFF events daily.
- 4.Random security setting allows to respectively postpone ON and OFF times by 0-30 minutes to create a "lived-in" look.
5. Turn on or off DTS with one simple push.

WARNING

- To prevent risk of electric shock, cut off power supply before installation.
- Always have a qualified electrician to install this product.

INSTALLATION

- STEP 1: CUT OFF POWER SUPPLY TO THE IN-WALL WIRING BOX.**
STEP 2: REMOVE THE EXISTING DEVICE IF ANY.
STEP 3: INSTALL THE TIMER.

A. SINGLE-POLE INSTALLATION

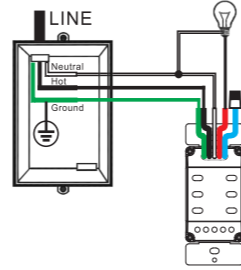

Note:

1. To replace an existing switch, please make sure that the neutral wire is available in the wall box.
2. Before wiring, please cut OFF the power at beaker and switch the timer to MANUAL OFF. (Please refer to the chapter SWITCHING BETWEEN TWO OPERATION MODES)
3. Wiring:
 - a. Ground wire: Connect the Ground wire in wall box (or the earth screw) to GREEN wire of the timer.
 - b. Neutral wire: Connect the Neutral wire in wall box (from breaker) to the WHITE wire of the timer. (The Neutral wire from breaker should also be connected to the load's neutral wire.)
 - c. Hot wire: Connect the hot wire in the wall box (from breaker) to the BLACK wire of the timer.
 - d. Load wire: Connect load's hot wire (from load such as light) to the RED wire of the timer.
 - e. Use a wire nut to twist the BLUE wire for safety.

B. 3-WAY INSTALLATION

Note:

1. To replace an existing switch, please make sure that the neutral wire is available in the wall box.
Also make sure that 5 travelers are available between the wall boxes and mark each wire (such as "HOT WIRE, NEUTRAL WIRE, TRAVELER 1, TRAVELER 2 ...") for identification first.
2. Before wiring, please cut OFF the power at beaker and switch the timer to MANUAL OFF. (Please refer to the chapter SWITCHING BETWEEN TWO OPERATION MODES)

3. Wiring:

- Step 1: Wiring the LINE side/TIMER**
- a. Ground wire: Connect the Ground wire in the wall box (or the earth screw) to the GREEN wire of the timer.
 - b. Neutral wire: Connect the Neutral wire in the wall box (from breaker) to the WHITE wire of the timer. (The Neutral wire from breaker should also be connected to the load's neutral wire)
 - c. Hot wire: Connect the Hot wire in wall box (from breaker) to the BLACK wire of the timer.
- d. Travelers:
- Traveler 1: Connect Traveler 1(from the 4-way switch box) to the BLUE wire of the timer.
- Traveler 2: Connect Traveler 2(from the 4-way switch box) with the RED wire of the timer.

Step 2: Wiring the 4-way switch

- a.Traveler 1: Connect Traveler 1(from the LINE side) to any of terminals of the 4-way switch.
- b.Traveler 2: Connect Traveler 2(from the LINE side) to Traveler 5 (from the LOAD side).
- c.Traveler 3: Connect Traveler 3(from the LOAD side) to one of terminals at another end of the 4-way switch.
- d.Traveler 4: Connect Traveler 4(from the LOAD side) to another terminal (at same end of Traveler 3) of the 4-way switch.

ATTENTION: Traveler 1 can't be connected to the terminal which is at same end of Traveler 3 or Traveler 4. Traveler 3 and Traveler 4 to the 3 way switch (in the LOAD side) have to be connected at same end.

Step 3: Wiring the LOAD side

- a.Traveler 5: Use a wire nut to connect together the load's hot wire, a jumper and Traveler 5(from the 4-way switch box), Then connect the jumper to

*Conventional 3-way installation

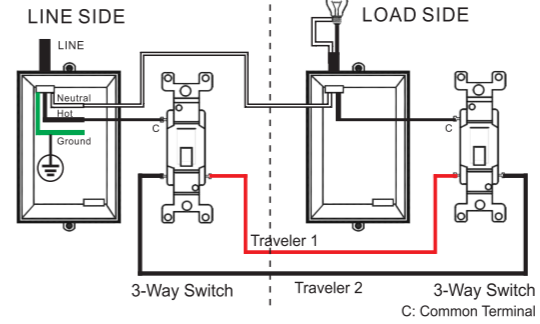

*Timer-on-the-line-side installation

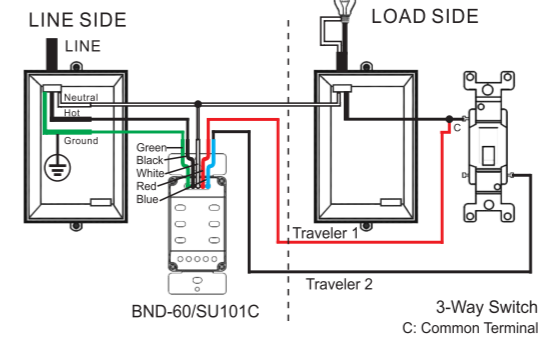

Note:

1. To replace an existing switch, please make sure that the neutral wire is available in the wall box.
2. Before wiring, please cut OFF the power at beaker and switch the timer to MANUAL OFF. (Please refer to the chapter SWITCHING BETWEEN TWO OPERATION MODES)

- COMMON terminal (usually black or copper colored) of the 3-way switch on the LOAD side.
- a.Traveler 3: Connect Traveler 3 (from the 4 way box side) to either terminal (usually brass colored) of the 3-way switch on the LOAD side.
 - c.Traveler 4: Connect Traveler 4 (from the 4 way box side) to the third terminal (usually brass colored) of the 3-way switch on the LOAD side.

*Timer-in-the-middle-box installation

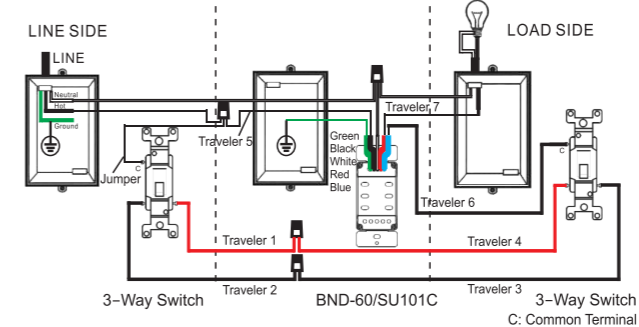

Note:

1. To replace an existing switch, please make sure that the neutral wire is available in the wall box.
Also make sure that 7 travelers are available between the wall boxes and mark each wire (such as "HOT WIRE, NEUTRAL WIRE, TRAVELER 1, TRAVELER 2 ...") for identification first.
2. Before wiring, please cut OFF the power at breaker and switch the timer to MANUAL OFF. (Please refer to the chapter SWITCHING BETWEEN TWO OPERATION MODES)

3. Wiring:

Step 1: Wiring the LINE side

- a. Ground wire: Connect the Ground wire in the wall box (or the earth screw) to the GREEN wire of the timer.
 - b. Neutral wire: Connect the Neutral wire in the wall box (from breaker) to the WHITE wire of the timer. (The Neutral wire from breaker should also be connected to the load's neutral wire)
 - c. Hot wire: Connect the Hot wire in wall box (from breaker) to the BLACK wire of the timer.
- d. Travelers:
- Traveler 1: Connect Traveler 1 (from load side) to the RED wire of the timer.
- Traveler 2: Connect Traveler 2 (from load side) to the BLUE wire of the timer.

Step 2: Wiring the LOAD side

- Traveler 1: Connect Traveler 1 (from the timer) and load's hot wire to the COMMON terminal (usually black or copper colored) of the 3-way switch.
- Traveler 2: Connect Traveler 2 (from the timer) to either terminal (usually brass colored) of the 3-way switch.

*Timer-on-the-load-side installation

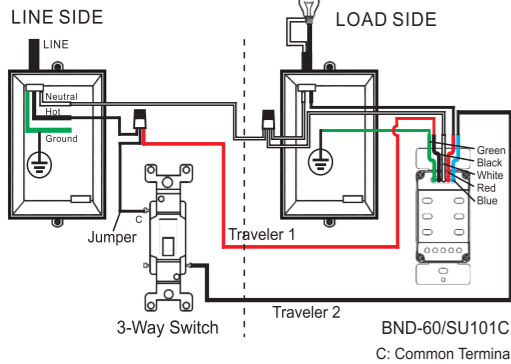

Note:

1. To replace an existing switch, please make sure that the neutral wire is available in the wall box.
2. Before wiring, please cut OFF the power at beaker and switch the timer to MANUAL OFF. (Please refer to the chapter SWITCHING BETWEEN TWO OPERATION MODES)

3. Wiring:

Step 1: Wiring the LINE side

- HOT wire: Connect the Hot wire in the wall box (from breaker) to Traveler 1 (from the timer) and the jumper, then connect jumper to COMMON terminal (usually black or copper colored) of the 3-way switch.
- Traveler 2: Connect Traveler 2 (from the timer) to either terminal (usually brass colored) of the 3-way switch.

Step 2: Wiring the LOAD side/TIMER

- a. Ground wire: Connect the Ground wire in the wall box (or the earth screw) to the GREEN wire of the timer.
- b. Neutral wire: Connect the Neutral wire in the wall box (from breaker) to the WHITE wire of the timer. (The Neutral wire from breaker should also be connected to the load's neutral wire)
- c. Load Hot wire: Connect the Load's Hot wire in wall box (from Load such as Light) to the RED wire of the timer.

d. Travelers:

- Traveler 1: Connect Traveler 1 (From LINE side) to the BLACK wire of the timer.
- Traveler 2: Connect Traveler 2 (From LINE side) to the BLUE wire of the timer.

C. 4-WAY INSTALLATION

*Conventional 4-way installation

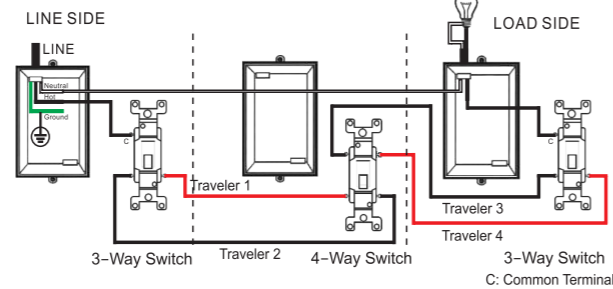

*Timer-on-the-line-side installation

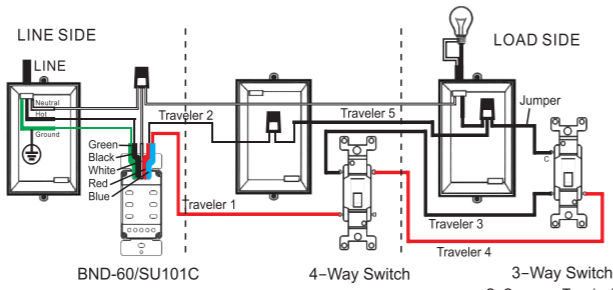

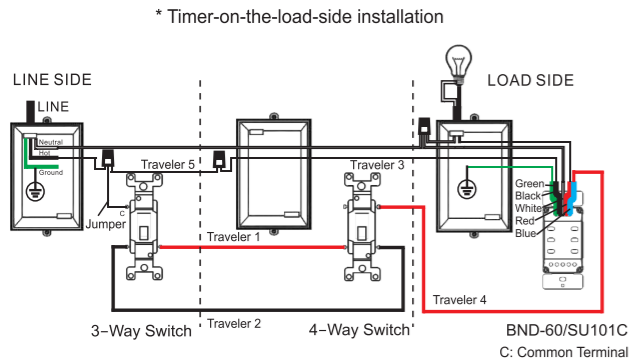

Note:

- To replace an existing switch, please make sure that the neutral wire is available in the wall box.
Also make sure that 5 travelers are available between the wall boxes and mark each wire (such as "HOT WIRE, NEUTRAL WIRE, TRAVELER 1, TRAVELER 2...") for identification first.
- Before wiring, please cut OFF the power at beaker and switch the timer to MANUAL OFF. (Please refer to the chapter SWITCHING BETWEEN TWO OPERATION MODES)
- Wiring:
Step 1: Wiring the LINE side
a. Use a wire nut to connect together the HOT wire (from breaker), a jumper and Traveler 5(from the 4-way switch box), then connect the jumper to COMMON terminal (usually black or copper colored) of the 3-way switch on the LINE side.
b. Traveler 1: Connect Traveler 1(from the 4-Way switch box) to either terminal (usually brass colored) of the 3-way switch on the LINE side.
c. Traveler 2: Connect Traveler 2(from the 4-Way switch box) to the third terminal (usually brass colored) of the 3-way switch on the LINE side.

Step 2: Wiring the 4-Way switch

- Traveler 1: Connect Traveler 1(from the LINE side) to any terminal of the 4-way switch.
- Traveler 2: Connect Traveler 2(from the LINE side) to the terminal (at same end of Traveler 1) of the 4-way switch.
- Traveler 4: Connect Traveler 4(from the LOAD side) to the third terminal (at another end) of the 4-way switch.
- Traveler 5: Connect Traveler 5(from the LINE side) to Traveler 3(from the LOAD side).

Step 3: Wiring the LOAD side/TIMER

- Ground wire: Connect the Ground wire in the wall box (or the earth screw) to the GREEN wire of the timer.
- Neutral wire: Connect the Neutral wire in the wall box (from breaker) to the WHITE wire of the timer. (The Neutral wire from breaker should also be connected to the load's neutral wire)
- Load Hot wire: Connect the Load's Hot wire in wall box (from Load such as Light) to the RED wire of the timer.
- Travelers:
Traveler 3: Connect Traveler 3 (from the 4-way switch) to the BLACK wire of the timer.
Traveler 4: Connect Traveler 4 (from the 4-way switch) to the BLUE wire of the timer.

STEP 4: FIX THE TIMER TO THE WIRING BOX AND THEN MOUNT THE FACE PLATE.

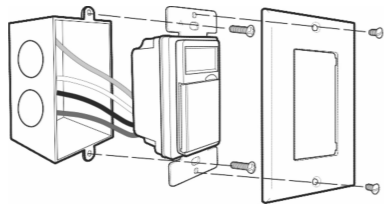

STEP 5: APPLY POWER TO THE WIRING BOX.

- When all ON/OFF events are programmed, press "MANUAL" button to return to the clock display screen.
If no button is pressed within 6 seconds, the timer will automatically save the settings and return to clock display screen.
You can review, change or delete any event in the same way you program an event.
- Press and hold "MANUAL" button till AUTO icon is shown so that the timer will run the programs.

SWITCHING BETWEEN TWO OPERATION MODES

The timer can work in two different operating modes: AUTO and MANUAL. They are represented by icons AUTO and MAN on the screen. Press and hold the "MANUAL" button for 4 seconds or longer to switch between these two operating modes. In either operation mode, you can press the "MANUAL" button to alter the timer's output status.

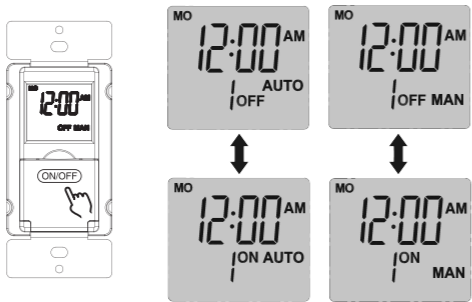

Day combination options:
MO to SU
Individual day: MO,TU,WE,TH,FR,SA,SU
MO to FR
SA, SU

- Press the "HOUR" button until 8:00am displays on the screen. (Fig 06)
Note: please pay attention to AM/PM.



Fig 06

- Press the "MIN" button until 8:05am displays on the screen. (Fig 07)



Fig 07

- Press the "PROG" button once to set program "1 OFF". The screen will display "1 OFF" and "PROG".(Fig 08)

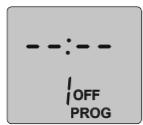

Fig 08

- Repeat steps 2 to 4 to set program "1 OFF". (Fig 09)



Fig 09

- During the programming process, you can clear the previous settings by pressing "CLR" button. Pressing the "CLR" a second time will resume the previous settings.
- If you want to set the second ON/OFF program, press "PROG" button again, you can repeat steps 2 to 6 to set program, or press the "MANUAL" to return the current time.
You can set up to 18 different ON and OFF programs for your timer. To do so, just repeat steps 1 to 6 for program "2 ON" "2 OFF" "3 ON" etc. . .

BUTTON LAYOUT AND SCREEN DISPLAY

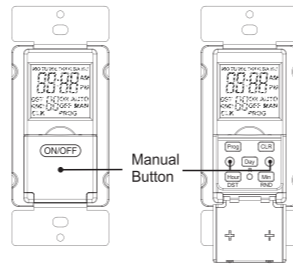
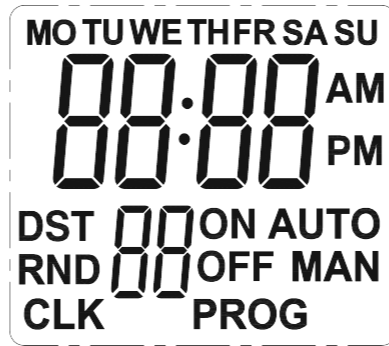

REMOVE STICKER

Locate the tab at the top right of the sticker and pull to remove sticker from face of screen.

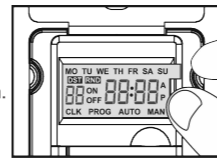

SWITCHING ON/OFF DST

Press and hold "Hour" button for 4 seconds or more to switch on or off DST.



DST is active when the DST icon is shown on the screen.

RANDOM SECURITY

To activate or deactivate the random security feature, press and hold the "Min" button for 4 seconds or more.

The "RND" icon on the screen indicates that the random function is active. In this case, the timer will respectively postpone the ON and OFF events by 0-30 minutes. Please note that at least one ON/OFF program shall be set to activate this feature.

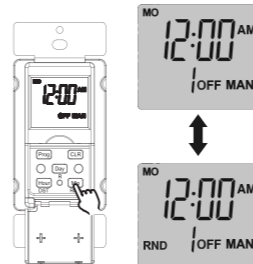

RESETTING THE TIMER

If the screen display is blank or faded, you can charge the battery for 10 minutes and then press the "RESET" button to reset the system. When the system is initialized, the screen display will be flashing. LCD display will appear like this icon.



Press any button at this time or wait 2 minutes without any operation, the clock will display.
Note: The system time and all settings will be erased after the system reset.

SETTING THE SYSTEM TIME

Example: if it is 12:08am Monday, please follow below steps to set the current day and time.

- Press the "PROG" button, then press the "DAY" button until "MO" displays on top of the screen. (Fig 01)
- Then press the "HOUR" button until 12:00am displays on the screen. (Fig 02)
Note: please pay attention to AM/PM.
- Then press the "MIN" button until 12:08am displays on the screen. (Fig 03)

Note: When the current time is correctly set, press "MANUAL" button to save and quit to clock display screen; or press "PROG" to start to set the programs.
If no button is pressed within 6 seconds, the timer will automatically save the current time and return to clock display screen.

TROUBLESHOOTING

- PROBLEM:** Timer does not turn on or off as programmed.
- POSSIBLE CAUSE:** Programs were not correctly set. DST or random function is active. The timer is working in manual mode. Programs are overlapped.
- CORRECTIVE ACTION:** Re-program the timer following the operating instructions. Deactivate DST or random function. Switch the operation mode to AUTO. Review and correct the programs or re-program the timer.

- PROBLEM:** No screen display or faded display.
- POSSIBLE CAUSE:** Low battery.
- CORRECTIVE ACTION:** Energize the timer to charge the internal battery for 10 minutes and then press RESET button to reset the timer.

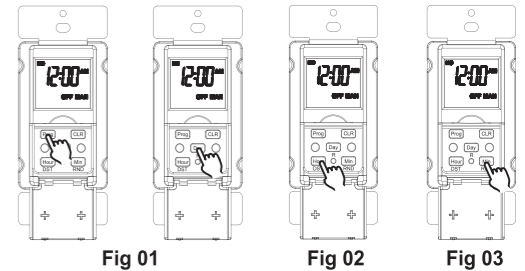

Fig 01

Fig 02

Fig 03

SETTING THE PROGRAM

- To start programming ON/OFF events, press "PROG" once during the system clock setting stage or press PROG twice in clock display screen. The screen will display "1 ON" and "PROG". (Fig 04)

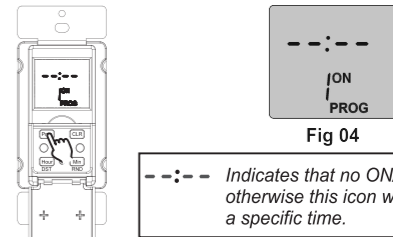

Fig 04

--:-- Indicates that no ON/OFF event is set, otherwise this icon will be replaced by a specific time.

- Example: if you want to turn on a device every day at 8:05am and turn it off at 9:00pm, please follow below steps.

- Press the "DAY" button to enter the program setting, you will see all the days of the week on the top and "1 ON" to the left of the display. (Fig 05)

Note: Press "DAY" multiple times until you get the day combination you want.



Fig 05