

IN-WALL COUNTDOWN TIMER

BND-60/U48

IMPORTANT PRODUCT INFO

- **Single Pole:** Timer will control devices from one location. Do not use in a 3-Way application where multiple switches control the same device.
- **Direct Wire:** This timer is only intended to be permanently installed into an electrical wall box.
- **Tool Required:** One (1) standard flathead screwdriver (not included).

INSTALLATION INSTRUCTIONS

1. Turn off power at circuit breaker or fuse box before uninstalling existing device or installing new timer.

2. Choose desired faceplate (white or metallic) and knob (white or black) to install on the timer.

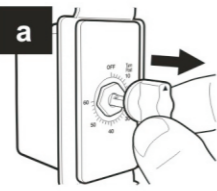

a. To remove current knob & faceplate, firmly pull the knob away from the timer.

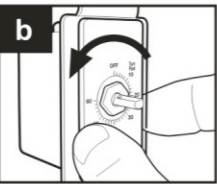

b. To loosen the washer, rotate attached faceplate counter-clockwise, unscrewing the washer to free the faceplate.

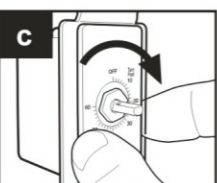

c. Attach desired faceplate and then rotate washer clockwise into place with fingers. Tighten by rotating attached faceplate clockwise, screwing the washer into place until secure.

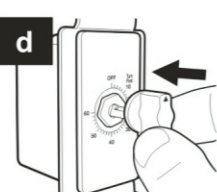

d. To install desired knob, position knob facing upward and align flat edge of post into the square receptacle on back of knob. Press knob down onto post until snug against faceplate.

- Remove existing wall plate and switch from wall box.
- Make sure the following 2 wires are present in the wall box. (see Diagram A)
 - 1 Hot Wire** from circuit breaker box.
 - 1 Load Wire** to the device to be powered.
 If these are not present, this Timing Device will not function properly. Additional wiring to the wall box will be required before installation of this timer can be completed.
- Strip wires 1/2 inch. (see Diagram A)
- Use the included wire nuts and securely twist together to attach the timer wires to the building wires.

NOTE: Either black timer wire can be attached to either "hot" or "load" wire. (see Diagram A)

From Timer	In Wall Box
Black Wire	Hot Wire
Black Wire	Load Wire

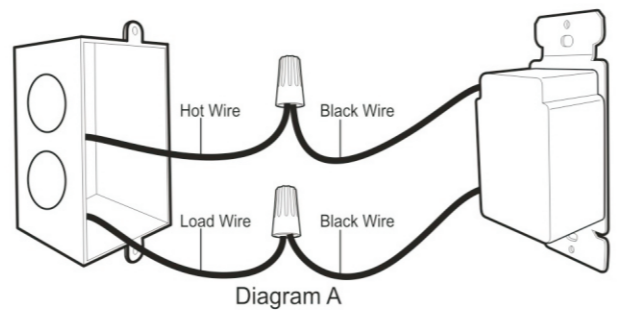

7. Insert timer into wall box (2-1/2 inch) being careful not to pinch any wires. Be sure timer is inserted correctly with the faceplate text reading upright. (see Diagram B)

8. Fasten timer to the wall box using the screws provided. (see Diagram B)

9. Place a rocker/decorator wall plate (not included) around the timer face. (see Diagram B)

10. Restore power at circuit breaker or fuse box.

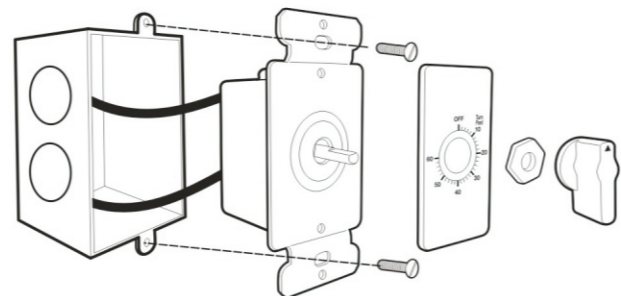

OPERATING INSTRUCTIONS

To activate COUNTDOWN PROGRAMMING

Turn the dial clockwise to any time interval (2 to 60 minutes). Attached devices will turn ON. Countdown starts immediately for the timed duration selected. Once the time runs out, attached devices will turn OFF.

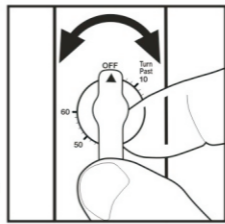

IN CASE OF POWER FAILURE

Timer will stop operating if the power goes out. It will continue counting down when the power is restored so check to be sure that the time that is set is still correct. If not, reprogram as desired following the OPERATING INSTRUCTIONS above.

TROUBLESHOOTING

PROBLEM	POSSIBLE CAUSE	CORRECTIVE ACTION
The attached device turns off immediately after being turned on.	The timer is wired incorrectly.	Disconnect wires, remove timer, re-install per the instruction manual. If problem persists, contact certified electrician.

⚠ WARNING

To avoid fire, shock, or death, turn off power at circuit breaker or fuse box before wiring. Installation by a licensed electrician to local, state and national codes is recommended. For INDOOR use only. Do not use to control appliances. Do not attempt to disassemble this timer. Do not exceed electrical ratings.

⚠ AVERTISSEMENT

Afin d'éviter les risques d'incendie, de choc électrique ou de décès, coupez l'alimentation électrique depuis le panneau de disjoncteurs ou de fusibles avant d'effectuer le câblage. Nous vous recommandons de faire appel à un électricien agréé afin qu'il procède à une installation conforme aux codes municipaux, provinciaux et nationaux. Pour un usage à l'INTÉRIEUR seulement. N'utilisez pas cet article pour commander des électroménagers. Ne tentez pas de démonter cette minuterie. Ne dépassez pas les capacités électriques.

HELPFUL TIPS

- To program a time interval below 10 minutes, first turn the dial clockwise past 10 and then counter-clockwise to the preferred time.

SAFETY INFORMATION & SPECIFICATIONS

THIS TIMER IS FOR USE WITH A 120 V AC POWER SOURCE.
125 V AC / 60 Hz

DO NOT ATTACH A DEVICE THAT EXCEEDS THE UNIT RATINGS:
20 A / 2,500 W Resistive (General Purpose)
8 A / 1,000 W Tungsten (Incandescent)
5 A / 625 W Ballast (Fluorescent)
1 HP (Horsepower Motor)

Customer Service Assistance: 1-909-592-1881
 Email: Support@centurytimer.com
 Business Hours of Operation: 9AM to 5PM Pacific time, Monday to Friday
 Manufactured and Distributed by: Century Products Inc.
www.centurytimer.com